

Linea Camera Link HS

Camera User's Manual

16k Monochrome CMOS Line Scan

sensors | cameras | frame grabbers | processors | software | vision solutions



P/N: 03-032-20249-01
www.teledynedalsa.com

 **TELEDYNE DALSA**
Everywhereyoulook™

Notice

© 2017 Teledyne DALSA

All information provided in this manual is believed to be accurate and reliable. No responsibility is assumed by Teledyne DALSA for its use. Teledyne DALSA reserves the right to make changes to this information without notice. Reproduction of this manual in whole or in part, by any means, is prohibited without prior permission having been obtained from Teledyne DALSA.

Microsoft and Windows are registered trademarks of Microsoft Corporation in the United States and other countries. Windows, Windows 7, Windows 8 are trademarks of Microsoft Corporation.

All other trademarks or intellectual property mentioned herein belong to their respective owners.

Document Date: March 20, 2017

Document Number: 03-032-20249-01

Contact Teledyne DALSA

Teledyne DALSA is headquartered in Waterloo, Ontario, Canada. We have sales offices in the USA, Europe and Asia, plus a worldwide network of representatives and agents to serve you efficiently. Contact information for sales and support inquiries, plus links to maps and directions to our offices, can be found here:

Sales Offices: <http://www.teledynedalsa.com/corp/contact/offices/>

Technical Support: <http://www.teledynedalsa.com/imaging/support/>

About Teledyne DALSA

Teledyne DALSA is an international high performance semiconductor and electronics company that designs, develops, manufactures, and markets digital imaging products and solutions, in addition to providing wafer foundry services.

Teledyne DALSA Digital Imaging offers the widest range of machine vision components in the world. From industry-leading image sensors through powerful and sophisticated cameras, frame grabbers, vision processors and software to easy-to-use vision appliances and custom vision modules.

Contents

LINEA CAMERA LINK HS SERIES OVERVIEW	3
DESCRIPTION	3
<i>Linea CLHS Application Advantages</i>	<i>4</i>
<i>Applications.....</i>	<i>4</i>
PART NUMBERS AND SOFTWARE REQUIREMENTS	5
SUPPORTED INDUSTRY STANDARDS.....	6
<i>GenICam</i>	<i>6</i>
<i>Camera Link HS</i>	<i>6</i>
CAMERA SPECIFICATIONS OVERVIEW	7
<i>Storage, Humidity and MTBF Specifications</i>	<i>8</i>
<i>Flash Memory Size</i>	<i>8</i>
<i>Compliance and EMI Certifications.....</i>	<i>8</i>
<i>Spectral Responsivity.....</i>	<i>9</i>
<i>Effective Quantum Efficiency</i>	<i>10</i>
CAMERA SETUP	11
SYSTEM PRECAUTIONS AND CLEANING	11
<i>Precautions</i>	<i>11</i>
<i>Cleaning the Device.....</i>	<i>11</i>
<i>Electrostatic Discharge and the Sensor</i>	<i>11</i>
<i>Handling</i>	<i>11</i>
CONNECTORS	12
<i>Power Connector.....</i>	<i>12</i>
<i>Data Cables.....</i>	<i>13</i>
<i>Establishing Camera Communications.....</i>	<i>13</i>
<i>Establishing Data Integrity</i>	<i>14</i>
INSTALL & CONFIGURE FRAME GRABBER & SOFTWARE	14
<i>Using Sopera CamExpert.....</i>	<i>14</i>
15	
CAMERA OPERATION	16
CAMEXPERT FOR LINEA CLHS CAMERAS	16
<i>CamExpert Panes</i>	<i>16</i>
<i>Creating a Camera Configuration File in the Host.....</i>	<i>18</i>
<i>Factory Settings.....</i>	<i>19</i>
<i>Open the CamExpert Panes</i>	<i>19</i>
TYPICAL SETUP AND EVALUATION	21
<i>Optical Configuration</i>	<i>21</i>
<i>Camera Timing & Control</i>	<i>21</i>
<i>Acquiring an Image</i>	<i>21</i>
CHECK CAMERA AND SENSOR INFORMATION	23
<i>Verify Temperature and Voltage.....</i>	<i>24</i>
<i>Pixel Format</i>	<i>24</i>
INTERNAL TEST IMAGE GENERATOR.....	25
CALIBRATING THE CAMERA.....	26
<i>Flat Field Parameters</i>	<i>28</i>
GAIN AND BLACK LEVEL (OFFSET).....	29

TRIGGER MODES	31
EXPOSURE CONTROLS	32
BINNING	35
PIXEL READOUT DIRECTION (MIRRORING MODE)	37
AREA OF INTEREST (AOI) SETUP	37
SAVING AND RESTORING CAMERA SETTINGS.....	40
<i>Camera Configuration Selection Dialog</i>	40
CAMERA FIRMWARE UPDATES.....	41
DOWNLOAD A LIST OF CAMERA PARAMETERS.....	42
FILE ACCESS VIA THE CAMEXPERT TOOL.....	42
TECHNICAL SPECIFICATIONS.....	44
MECHANICAL SPECIFICATIONS.....	44
ADDITIONAL NOTES ON LINEA CLHS IDENTIFICATION AND MECHANICAL.....	45
ADDITIONAL REFERENCE INFORMATION	47
OPTICAL CONSIDERATIONS	47
<i>Illumination</i>	47
<i>Light Sources</i>	47
<i>Lens Modeling</i>	48
<i>Magnification and Resolution</i>	48
SENSOR HANDLING INSTRUCTIONS	49
<i>Electrostatic Discharge and the Sensor</i>	49
<i>Protecting Against Dust, Oil and Scratches</i>	49
<i>Cleaning the Sensor Window</i>	50
APPENDIX A: GENICAM COMMANDS.....	51
CAMERA INFORMATION CATEGORY	51
<i>Camera Information Feature Descriptions</i>	51
CAMERA CONTROL CATEGORY	53
<i>Camera Control Feature Descriptions</i>	53
I/O CONTROL CATEGORY	54
<i>I/O Control Feature Descriptions</i>	54
FLAT FIELD CATEGORY.....	54
<i>Flat Field Feature Descriptions</i>	54
IMAGE FORMAT CONTROL CATEGORY	55
<i>Image Format Control Feature Description</i>	55
TRANSPORT LAYER CATEGORY	56
<i>Transport Layer Feature Descriptions</i>	56
DEVICE STREAMING REGISTERS.....	58
<i>Start – End Command Requirements</i>	58
FILE ACCESS CONTROL CATEGORY.....	58
<i>File Access Control Feature Descriptions</i>	58
APPENDIX C: ERROR AND WARNING MESSAGES.....	60
BIST: BUILT IN SELF TEST	60
OPERATIONAL ERROR CODES	61
DOCUMENT REVISION HISTORY.....	62

Linea Camera Link HS Series Overview

Description

The new Linea™ line scan cameras deliver the exceptional performance and features found in Teledyne DALSA's current lineup of high-end cameras at an unprecedented price point.

Based on the most advanced CMOS line scan technology, the Linea Camera Link HS (CLHS) cameras have a 16k single line $3.52 \mu\text{m} \times 3.52 \mu\text{m}$ pixel array at a 71 kHz maximum line rate with Camera Link HS output.

With excellent sensitivity and speed, Linea surpasses the requirements of demanding applications—such as materials grading and inspection, transportation safety, and general purpose machine vision.

The Linea lineup of cameras are compact, light-weight, robust and feature-rich—including flat-field correction, multiple ROI and AOI, multiple user configuration sets, and calibration coefficients for various lighting conditions.

The Linea CLHS camera is one of a new series of affordable and easy-to-use digital cameras specifically engineered for industrial imaging applications requiring embedded image processing and improved network integration.

These Linea cameras use industry standard Camera Link HS protocol to dependably capture and transfer images from the camera to the host PC.

The GenICam compliant Linea is easy to set up and integrate using a GUI, such as Teledyne DALSA's Sopera camera configuration utility CamExpert.



Linea CLHS Application Advantages

- High speed: up to 71 kHz
- 16,384 pixel resolutions
- Compact and robust camera body
- Multiple regions of interest for calibration and data reduction
- 8 bit or 12 bit output
- Small flat field and lens shading correction
- 8 programmable coefficient sets
- GenICam compliant interfacing

Applications

- Automated optical inspection
- Security systems
- High performance sorting systems
- Materials grading and inspection systems
- Web inspection
- General purpose machine vision

Part Numbers and Software Requirements

This manual covers the Linea Camera Link HS models summarized below. New models are added to this manual as they are released by Teledyne DALSA.

Camera	Resolution	Pixel size	Max. Line Rate	Lens Mount (threaded)	Product Number
Linea 16k CLHS	16384 x 1	3.52 μm x 3.52 μm	71 kHz	M72 x 1	LA-HM-16K07A-00-R

Accessories	Order Number
M72 x 0.75 F, F-mount adapter 12 mm BFD lens, heavy duty	AC-LN-00001-xx-R
Heat sink, optional	AC-MS-00115-xx-R
For a list of accessories go to http://www.teledynedalsa.com/imaging/products/cameras/accessories/	
Optical filters are available from http://www.midwestopticalsystems.com/	

Teledyne DALSA Software Platform	
Sapera LT version 7.50 or higher includes CamExpert GUI application	Available for free download:
Sapera provides everything needed to develop imaging applications.	http://www.teledynedalsa.com/imaging/products/software/sapera/lt/
Camera Firmware	Embedded within camera
GenICam support (XML camera description file)	Embedded within camera
Sapera Processing Imaging Development Library (available for Windows or Linux - sold separately)	Contact Teledyne DALSA Sales

Third Party GenICam GenCP Software Requirements	
Support of GenICam GenApi version 2.3	General acquisition and control. File access: firmware, FFC, configuration data, upload & download.
Support of GenICam XML schema version 1.1	
GenICam support — XML camera description file	Embedded within Linea CL

Supported Industry Standards

GenICam

The Linea CLHS camera is GenICam™ compliant and implements a superset of the GenICam Standard Features Naming Convention specification V1.5.

This description takes the form of an XML device description file using the syntax defined by the GenApi module of the GenICam specification. The camera uses the GenICam Generic Control Protocol (GenCP V1.0) to communicate over the Camera Link HS command lane.

For more information see www.genicam.org.

Camera Link HS

The Linea CLHS camera is Camera Link HS™ version 1.0 compliant. Camera Link HS is the next generation of high performance communications standards and is used where a digital industrial camera interfaces with single or multiple frame grabbers with data rates exceeding those supported by Camera Link.

The Linea CLHS camera includes one Camera Link HS compatible connector, capable of supporting data rates up to 1.25 gigabytes per second (Gbps). The connector can also interface with standard 'CX4 Active Optical Cable' fiber modules where very long data transmission is required—up to 300 meters.

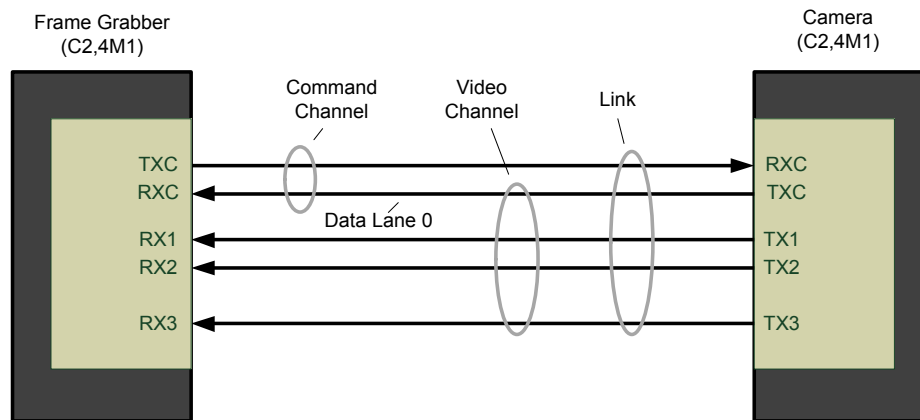

Figure 1. Single CLHS Connector Configuration

The command channel is used by the frame grabber to send command, configuration, and programming data to the camera and to receive command responses, status, and image data from the camera.

The designation C2, 4M1 defines the use of a SFF-8470 connector (C2) and up to 4 lanes of data with 1 command channel using M-Protocol (8b/10b) at the default speed of 3.125 Gbps.

An additional feature of CLHS is that the initialization of the frame grabber automatically starts a discovery process that will identify the lane configuration of the camera. This process is transparent to the user and requires no action by the user to correctly configure the link.

Camera Specifications Overview

Specifications	Performance
Imager Format	High speed CMOS line scan
Resolution	16, 384 pixels
Pixel Size	3.52 μm x 3.52 μm
Pixel Fill Factor	100 %
Line Rate	71 kHz, maximum
Exposure Time	4 μs to 3 ms
Bit Depth	8 bit or 12 bit, selectable
Connectors and Mechanicals	
Control & Data Interface	Camera Link HS
Power Connector	Hirose 6-pin male circular
Supply Voltage	+12 V to + 24 V DC (+11.4 V to +25.2 V maximum limits)
Power	< 15 W
Size	76.0 mm (W) x 76.0 mm (H) x 52.86 mm (D)
Mass	< 360 g
Operating Temp	0 °C to +65 °C, front plate temperature
Optical Interface	
Sensor to Camera Front Distance	12 mm
Sensor Alignment (aligned to sides of camera)	
\ominus y (parallelism)	0.08° or 100 μm
x	\pm 300 μm
y	\pm 300 μm
z	\pm 300 μm
\ominus z	\pm 0.3°

Operating Ranges	Performance	Notes
Dynamic Range	> 60 dB	
Random Noise	< 4 DN* rms	FFC enabled
Broadband Responsivity	80 DN / (nJ / cm ²)	
Gain Nominal range	1x to 10x	
DC Offset	7 DN	FFC enabled
PRNU	< 1.5% @ 50% Sat	
FPN	< 5 DN	
SEE	50 nJ / cm ²	
NEE	50 pJ / cm ²	
Antiblooming	> 100 (x Saturation)	
Integral non-linearity	1.5 % DN	

*DN = digital number

Test Conditions:

- Values measured using 12-bit @ 1x gain.
- 10 kHz line rate.
- Light source: broadband, quartz halogen, 3250 K with 700 nm IR cut-off filter.
- Front plate temperature: 45° C.

Storage, Humidity and MTBF Specifications

Environmental Specifications	
Storage temperature range	-20 °C to +80 °C
Humidity (storage and operation)	15% to 85% relative, non-condensing
MTBF (mean time between failures)	>100, 000 hours, typical field operation

Flash Memory Size

Camera	Flash Memory Size
LA-HM-16K07A	16 MByte

Compliance and EMI Certifications

Compliance Directives	Standards ID	Overview
CE	EN55032 (2012)	Electromagnetic compatibility of multimedia equipment – Emission requirements
	EN55011 (2009) with A1(2010)	Industrial, scientific and medical equipment – Radio-frequency disturbance characteristics – Limits and methods of measurement
	EN 61326-1 (2013)	Electrical equipment for measurement, control and laboratory use – EMC requirements – Part 1: General requirements
	EN 55024 (2010)	Information technology equipment – Immunity characteristics – Limits and methods of measurement
	CISPR 11	Industrial, scientific and medical equipment – Radio-frequency disturbance characteristics – Limits and methods of measurement
	CISPR 32	Electromagnetic compatibility of multimedia equipment - Emission requirements
FCC	Part 15, class A	
RoHS	Compliance as per European directive 2004/105/EC	
For an image of the Linea CLHS certificate see the section.		

Spectral Responsivity

The responsivity graph describes the sensor's response to different wavelengths of light (excluding lens and light source characteristics).

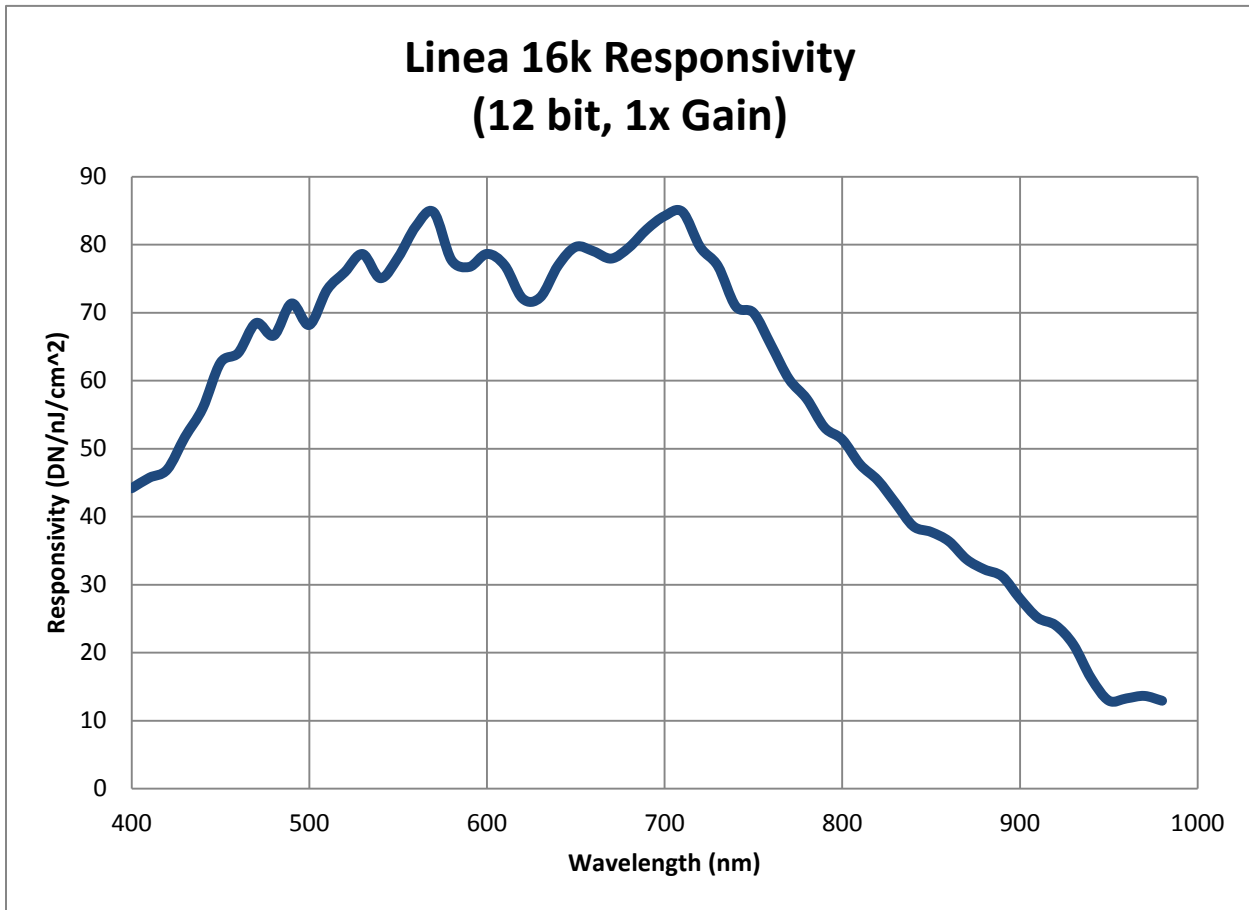

Effective Quantum Efficiency

The quantum efficiency graph describes the fraction of photons at each wavelength that contribute charge to the pixel.

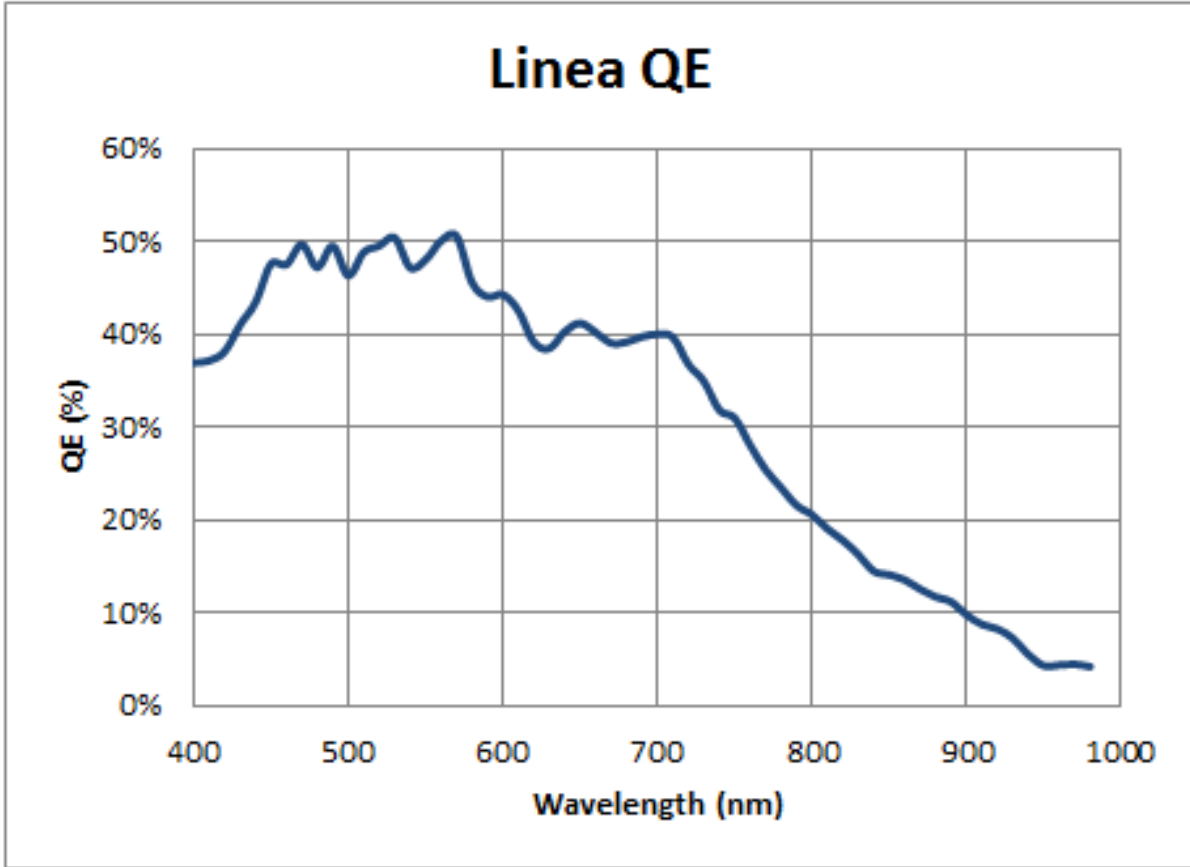

Camera Setup

System Precautions and Cleaning

Precautions

- Read these precautions and the rest of the information in this manual before using the camera.



Do not open the housing of the camera. The warranty is voided if the housing is opened.

- Confirm that the camera's packaging is undamaged before opening it. If the packaging is damaged please contact the related logistics personnel.
- Keep the camera's front plate temperature in a range of 0 °C to +65 °C during operation.
- Do not operate the camera in the vicinity of strong electromagnetic fields. In addition, avoid electrostatic charging, violent vibration, and excess moisture.
- Though this camera supports hot plugging, it is recommended that you power down and disconnect power to the camera before you add or replace system components.

Cleaning the Device

To clean the device, avoid electrostatic charging by using a dry, clean absorbent cotton cloth dampened with a small quantity of pure alcohol. Do not use methylated alcohol.

To clean the surface of the camera housing, use a soft, dry cloth. To remove severe stains use a soft cloth dampened with a small quantity of neutral detergent and then wipe dry. Do not use volatile solvents such as benzene and thinners, as they can damage the surface finish.

Electrostatic Discharge and the Sensor

Image sensors and the camera bodies housing are susceptible to damage from electrostatic discharge (ESD). Electrostatic charge introduced to the sensor window surface can induce charge buildup on the underside of the window. If this occurs, the charge normally dissipates within 24 hours and the sensor returns to normal operation.

Handling

Warning! Depending on the mounting design and the operating conditions the camera body could become hot. You must take precautions to ensure your safety and avoid touching the camera directly during operation.

Connectors

The camera has two connectors:

- A **Hirose 6-pin** connector for camera power.
- A **CLHS** connector for control and video data transmitted to / from the host computer.

The following figure of the camera's backend shows connector and LED locations. See the Mechanical Specifications section for details on the connector placements and camera mounting dimensions.

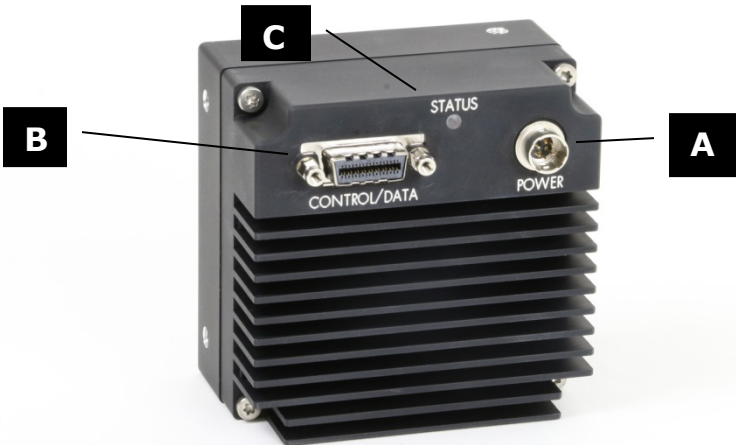

Power	
A	Hirose 6-pin +12 V to +24 V DC
Control & Data	
B	Camera Link HS connector
Status	
C	Diagnostic LED. See <i>description below.</i>

Power Connector



WARNING! Grounding Instructions

It is extremely important that you apply the appropriate voltages to your camera. Incorrect voltages may damage the camera. Input voltage requirements: +12 VDC to +24 VDC, 2 Amp. Before connecting power to the camera, test all power supplies.

Hirose 6-pin Circular Male (Mating Part: HIROSE HR10A-7P-6S)

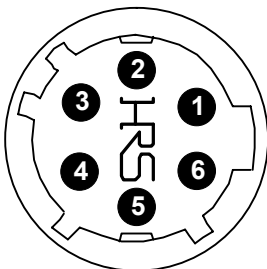

Pin	Description	Pin	Description
1	+12 V to +24 V DC	4	GND
2	+12 V to +24 V DC	5	GND
3	+12 V to +24 V DC	6	GND

Data Cables

The Camera Link HS cables are made to handle very high data rates. Cable length can be up to 15 meters. Camera Link HS cables can be bought from an OEM. OEM cables are also available for applications where flexing is present. Please see Teledyne DALSA's website (www.teledynedalsa.com) for a list of qualified vendors and part numbers.

If you want to fabricate your own cables, please refer to the Camera Link HS Specification Version 1.0 for printout details and design guidelines. Each data cable is used for sending image data to and accepting command data from the frame grabber. Command data includes GenICam compliant messages, trigger timing, and general purpose I / O, such as direction control.

The camera meets all performance specifications using standard switching power supplies, although well-regulated linear supplies provide optimum performance.



WARNING: When setting up the camera's power supplies follow these guidelines:

- Apply the appropriate voltages.
- Protect the camera with a 1 or 2 amp slow-blow fuse between the power supply and the camera.
- Do not use the shield on a multi-conductor cable for ground.
- Keep leads as short as possible in order to reduce voltage drop.
- Use high-quality supplies in order to minimize noise.

Camera Status LED

The camera has a single multicolor LED to provide a simple visible indication of camera state. The table below summarizes the operating states of the camera and the corresponding LED states. When more than one condition is active, the LED indicates the condition with the highest priority.

Establishing Camera Communications

Power up the camera and observe the LED which indicates the following status conditions:

LED State	Description
Off	Camera is not powered up or is waiting for the software to start.
Constant Red	The camera BIST status is not good. See BIST status for diagnosis. CamExpert can be used to get the BIST value from the camera.
Blinking Red	The camera has shut down due to a temperature problem.
Blinking Orange	Powering Up. The microprocessor is loading code.
Blinking Green	Hardware is good but the CLHS connection has not been established or has recently been broken.
Constant Green	The CLHS Link has been established and data transfer may begin.

When the camera status indicator LED state is a constant green, the camera is ready to start the first instance of CamExpert:

- CamExpert will search for installed Sapera devices.
- In the Devices list area on the left side of the window, the connected frame grabber will be shown.
- Select the frame grabber device by clicking on the name.

Start the second instance of CamExpert

- CamExpert will again search for any installed Sapera devices.
- In the Devices list area on the left side, the connected camera will be shown.
- Select the camera device by clicking on the name.

The XML is automatically read from the camera and CamExpert will use it to set up the panes detailing the configurable functionality of the camera.

The two CamExpert instances can now be used to set up the camera and frame grabber for capturing the first images.

Establishing Data Integrity

- Use the camera's internal triggering. This will allow initial imaging with a static object and no encoder input will be required.
- Enable the camera to output a test pattern.
- Use a frame grabber CamExpert instance to capture, display, and analyze the test pattern image to verify the integrity of the connection. If the test pattern is not correct, check the cable connections and the frame grabber setup.
- Disable the test pattern output.

Install & Configure Frame Grabber & Software

We recommend the Teledyne DALSA XTIUM frame grabber, or equivalent, described in detail on the teledynedalsa.com site [here](#). Follow the manufacturer's installation instructions.

A GenICam compliant XML device description file is embedded within the camera firmware allowing for GenICam compliant applications to recognize the camera's capabilities immediately after connection. Installing Sopera LT gives you access to the CamExpert GUI, a GenICam compliant application.

Using Sopera CamExpert

CamExpert is the camera GUI supported by the Sopera library. When used with a Linea CLHS camera, CamExpert allows the user to test all camera operating modes.

In addition, CamExpert can be used to save the camera's user settings configurations to the camera. Or save multiple configurations as individual camera parameter files on the host system (*.ccf). CamExpert can also be used to upgrade the camera's software.

An important component of CamExpert is its live acquisition display window. This window allows the user to immediately verify the timing or control parameters without needing to run a separate acquisition program.

To control the camera and frame grabber settings, the user must open two instances of CamExpert—one is used to control the frame grabber features and as a display window. The second instance is used to control the camera features.

For context sensitive help, click on the  button and then click on a camera configuration parameter.

A short description of the configuration parameter will be shown in a popup. Click on the  button to open the help file for more descriptive information on CamExpert.

The central section of CamExpert provides access to the camera features and parameters. **Note:** The availability of features depends on the CamExpert user setting. Not all features are available to all users.



A note on the CamExpert examples shown here: The examples shown for illustrative purposes and may not entirely reflect the features and parameters available from the camera model used in your application.

Camera Operation

CamExpert for Linea CLHS Cameras

The Sapera CamExpert tool is the interfacing tool for GenCP compliant Camera Link cameras, and is supported by the Sapera library and hardware. When used with a camera, CamExpert allows a user to test most of the operating modes. Additionally CamExpert saves the camera's user settings configuration to the camera or saves multiple configurations as individual camera parameter files on the host system (*.ccf).

An important component of CamExpert is its live acquisition display window which allows immediate verification of timing or control parameters without the need to run a separate acquisition program.

Click on any parameter and a short description is displayed below the Category pane. The same context sensitive help is available by clicking on the  button then click on a camera configuration parameter. Click on the  button to open the help file for more descriptive information on CamExpert.







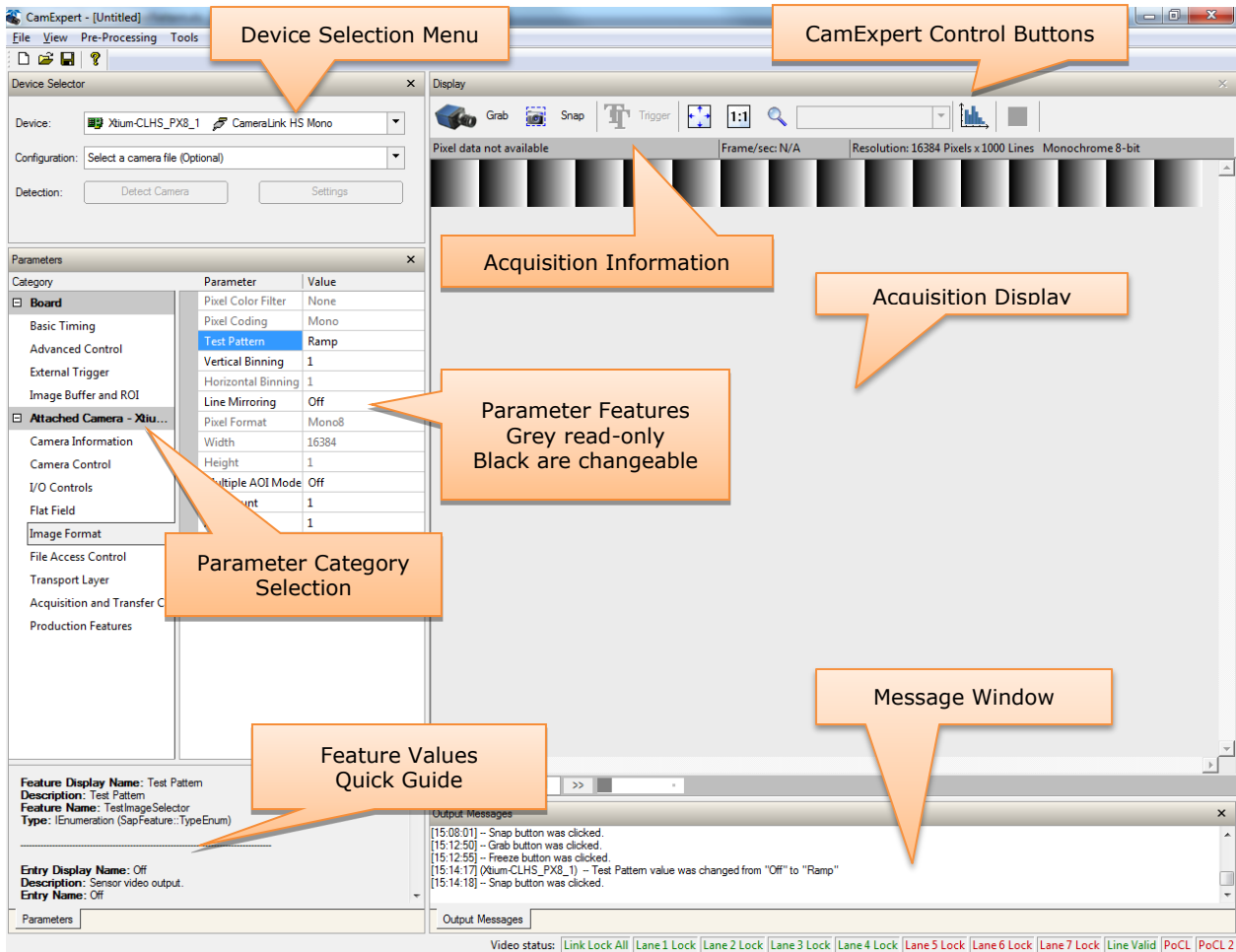

Note: The examples shown may not entirely reflect the features and parameters available from the camera model and camera mode used in your application.

CamExpert Panes

The various areas of the CamExpert tool are described in the figure below. Device categories and parameter features are displayed as per the device's XML description file. The number of parameters shown is dependent on the View mode selected (Beginner, Expert, Guru – see description below).



- **Device Selector pane:** View and select from any installed Sapera acquisition device. After a device is selected, CamExpert will only present parameters applicable to that device. Optionally select a camera file included with the Sapera installation or saved by the user.
- **Parameters pane:** Allows viewing or changing all acquisition parameters supported by the acquisition device. CamExpert displays parameters only if those parameters are supported by the installed device. This avoids confusion by eliminating parameter choices when they do not apply to the hardware in use.
- **Display pane:** Provides a live or single frame acquisition display. Frame buffer parameters are shown in an information bar above the image window.
- **Control Buttons:** The Display pane includes CamExpert control buttons. These are:

 Grab  Freeze	Acquisition control button: Click once to start live grab, click again to stop.
 Snap	Single frame grab: Click to acquire one frame from device.
 Trigger	Software trigger button: With the I/O control parameters set to Trigger Enabled / Software Trigger type, click to send a single software trigger command.
	CamExpert display controls: (these do not modify the frame buffer data) Stretch (or shrink) image to fit, set image display to original size, or zoom the image to any size and ratio. This does not affect the acquisition.
	Histogram / Profile tool: Select to view a histogram or line/column profile during live acquisition.

- **Output pane:** Displays messages from CamExpert.

CamExpert View Parameters Option

All camera features have a Visibility attribute which defines its requirement or complexity. The states vary from Beginner (features required for basic operation of the device) to Guru (optional features required only for complex operations).

CamExpert presents camera features based on their visibility attribute. CamExpert provides quick Visibility level selection via controls below each Category Parameter list [<< Less More >>]. The user can also choose the Visibility level from the *View · Parameters Options* menu.

Creating a Camera Configuration File in the Host

- When using the Teledyne DALSA Sopera SDK – the CCF is created automatically via a save.
- When using a 3rd party SDK application, if that SDK supports **GenAPI 2.4**, then the process is automatic. Simply follow the 3rd party *Save Camera* method as instructed.
- If the SDK is based on **GenAPI 2.3** or lower, the user must call the command `DeviceFeaturePersistenceStart` before using the SDK *Save Camera* method and the command `DeviceFeaturePersistenceEnd` at the end of the save function.

The following sections describe typical operations performed with the camera. The descriptions rely on the feature-based Camera Link GenCP protocol, using the Sopera CamExpert application.

If you are using a different application, the display configuration will look different, but the category, parameter (feature) names, and possible values will be the same. References to related ASCII commands are provided.

Factory Settings

The camera has been calibrated and configured at the factory to be ready for operation when first powered up. The camera ships and powers up for the first time with the following factory settings:

- Maximum horizontal width (16,384 pixels)
- Internal trigger, line rate 10 kHz
- Internal exposure control, exposure time 50 μ s
- Offset 0, Gain 1x (lowest value)
- Flat field calibration is not active, as this feature is dependent on your light source and lens

Open the CamExpert Panes

CamExpert, first instance: select Camera Link HS Mono from the Device drop-down menu:

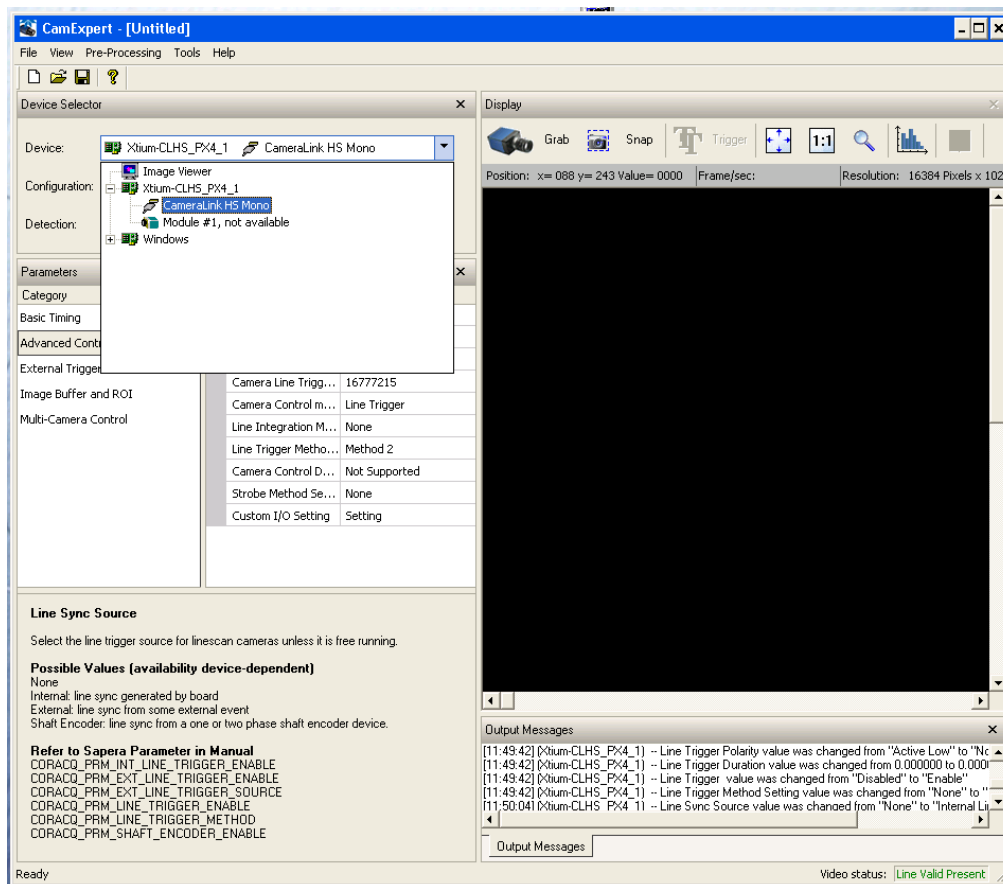

Figure 2. CamExpert Frame Grabber Control Window

CamExpert, second instance: select LA_HM_16k07A_00_R from the Device drop-down menu.

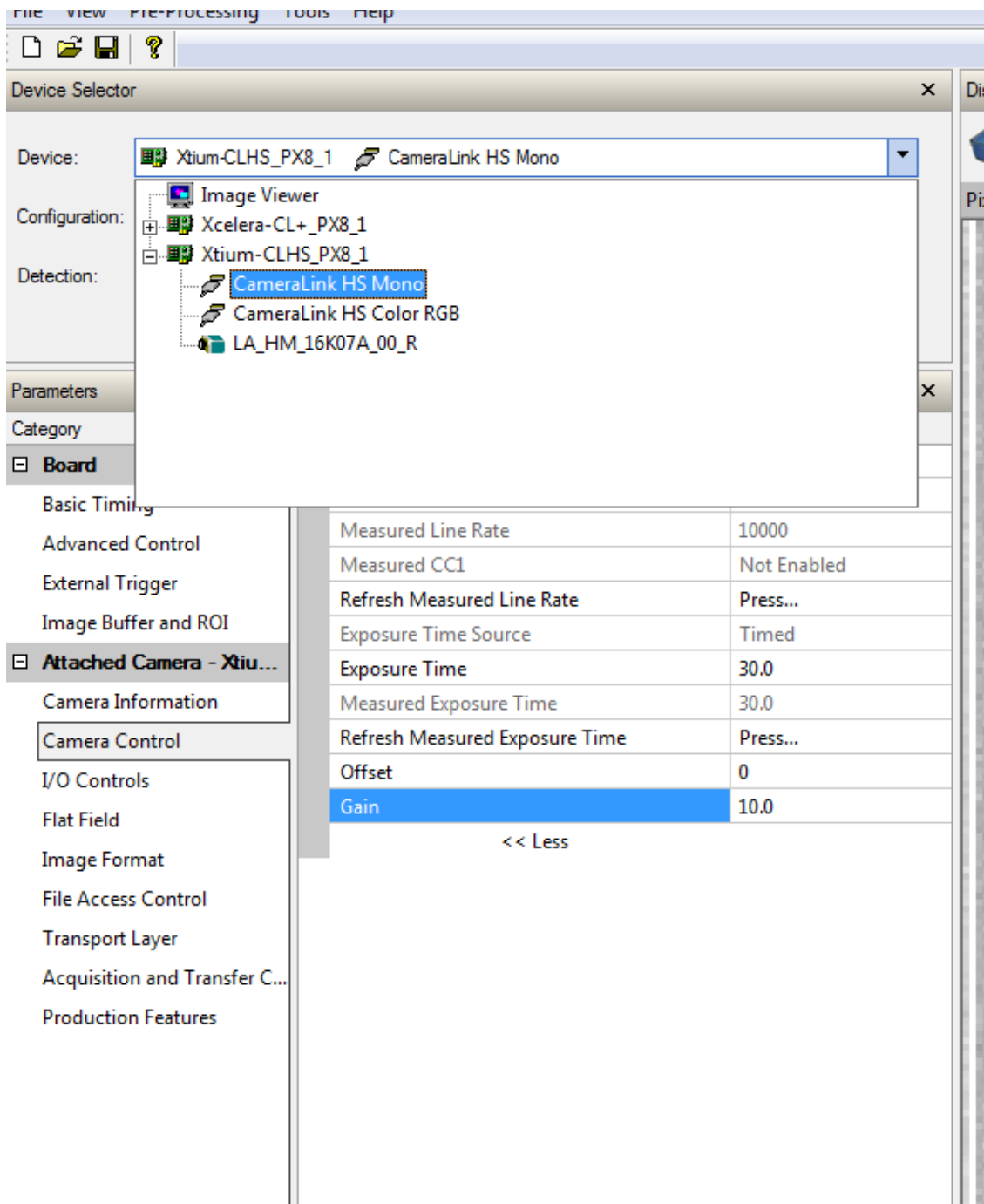

Figure 3. CamExpert Camera Control Window

At this point you are ready to start operating the camera in order to acquire images, set camera functions, and save settings.

Typical Setup and Evaluation

Optical Configuration

Typically, the first thing you want to do is to evaluate the camera's image quality under operating conditions similar to those you will use in your application. To do this, take the following steps:

- The illumination, lens magnification, and focus should be set up as per your application.
- Getting the magnification right is best accomplished by setting the object-to-sensor distance. Use the formula $\text{lens focal length} \times (2 + 1/\text{magnification} + \text{magnification})$ to calculate this distance. Magnification equals the sensor pixel size (7.04 μm or 3.52 μm) / (your object pixel size in μm).
- The back focal distance from the front plate to the sensor is 12 mm. For complete mechanical specifications refer to the Mechanical Specifications section.

Camera Timing & Control

It is easiest and quickest to evaluate the camera using the internal timing setups for line rate and exposure time. The camera starts up in the default configuration of Camera Link full, 10 kHz line rate and 50 μsec exposure time.

- If this line rate is too slow for your application, you will get a compressed image in the scan direction. To increase the line rate, use the Internal Line Rate parameter in the Camera Control category.
- Adjust the exposure time; refer to the Exposure Controls section.
- Set your camera direction; refer to the Pixel Readout Direction (Mirroring Mode) section.

Acquiring an Image

You can now begin imaging.

- Use the system gain to adjust the camera output to achieve the desired response. The system gain range is from 1x to 10x. Refer to the Gain and Black Level (Offset) section.
- Once you have a suitable response, you can now focus the lens.
- The image may be darker at the edges due to lens vignetting, but this will be improved once the camera is calibrated.

Calibration is performed using a white reference where your object is normally located. Refer to the

- Calibrating the Camera section. When calibrated, you should see an image from the camera that is flat field corrected with the lens at the target level you set.

You are now ready to evaluate the image quality of the camera under your operating conditions.

Check Camera and Sensor Information

Camera and sensor information can be retrieved via a controlling application—for example, the CamExpert GUI shown in the following examples. Parameters such as camera model, firmware version, sensor characteristics, and so forth, are read to uniquely identify the connected device. The parameters used to select, load and save user sets are grouped together under the Camera Information > Power-up Configuration category.

Parameters		
Category	Parameter	Value
Board Basic Timing Advanced Control External Trigger Image Buffer and ROI	Model	LA_HM_16K07A_00_R
	Vendor	Teledyne_DALSA
	Serial Number	19620110
	Device User ID	
	Microcode Version	03-081-20418-00
	CCI Version	03-110-20412-01
	FPGA Version	03-056-20586-01
	Power-on Status	Good
	LED Color	Green
	Temperature	40.400002
Attached Camera - Xtiu... Camera Information Camera Control I/O Controls Flat Field Image Format File Access Control Transport Layer Acquisition and Transfer C... Production Features	Refresh Temperature	Press...
	Input Voltage	10.5
	Refresh Voltage	Press...
	Power-up Configuration	Setting...
	<< Less	

Verify Temperature and Voltage

To determine the voltage and temperature at the camera, use the **Refresh Voltage** and **Refresh Temperature** features.

The temperature returned is the internal temperature in degrees Celsius. For proper operation this value cannot exceed 80 °C. If the camera exceeds the designated temperature it will stop imaging and the LED will turn red. After you have diagnosed and remedied the issue use the **Restart Camera** function.



Note: The voltage displayed is the camera's input voltage. The voltage measurement feature of the camera provides results within 1% of the actual voltage. The measurement can be used to set the applied voltage to the camera.

Pixel Format

Use the Pixel Format feature, found in the **Image Format** category, to select the format of the pixel to use during image acquisition as either Mono 8 or Mono 12 bit depth.

Note: to change the pixel format you must *first* stop image acquisition in the Acquisition and Transfer Control category.

Image Format	
Parameter	Description
Pixel Format	Sets the sensor pixel format. Possible values are: Mono 8* Mono 12

Internal Test Image Generator

The camera includes a number of internal test patterns which can easily confirm camera cable connections or driver installations, without the need for a camera lens or proper lighting. The patterns are subject to camera processing, such as binning functions.

Use CamExpert to easily enable and select any test pattern from the drop menu while the camera is not in acquisition mode. Select live grab to see the pattern output.

The Test Pattern feature is available in the **Image Format** category:

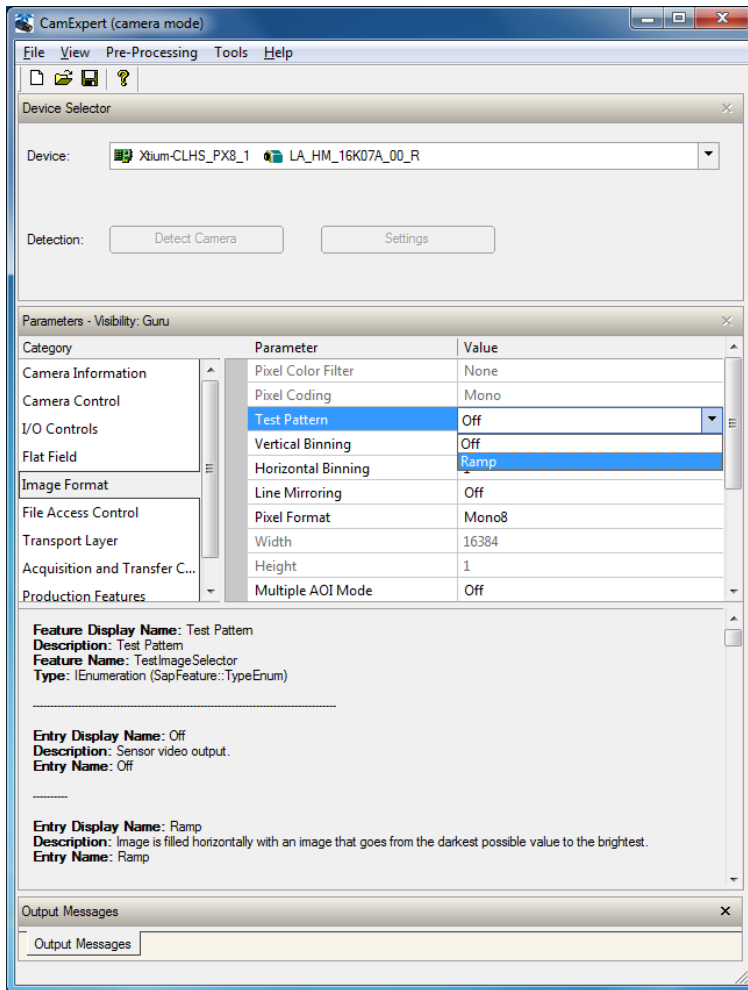

Image Format		
Parameter	Description	
Test Pattern	Enable camera sensor test pattern. Possible values are:	
	<i>Off</i>	Image is from the camera sensor.
	<i>Ramp</i>	Image is filled horizontally with an image that goes from the darkest possible value to the brightest.

Calibrating the Camera



Important Note: to ensure best results, the conditions under which you calibrate the camera (for example, temperature and illumination) should be as close to the actual operating conditions as possible.

The goal of calibration is for the camera to produce a uniform output image at a desired level while imaging a uniform white object under conditions equal to the application's optical setup. Flat field coefficients are made up of an offset and gain for each pixel. These are the first user corrections applied to the image. The flat field coefficients are saved and loaded with the user set.

The following diagram illustrates the camera's digital processing chain and associated GeniCam features.

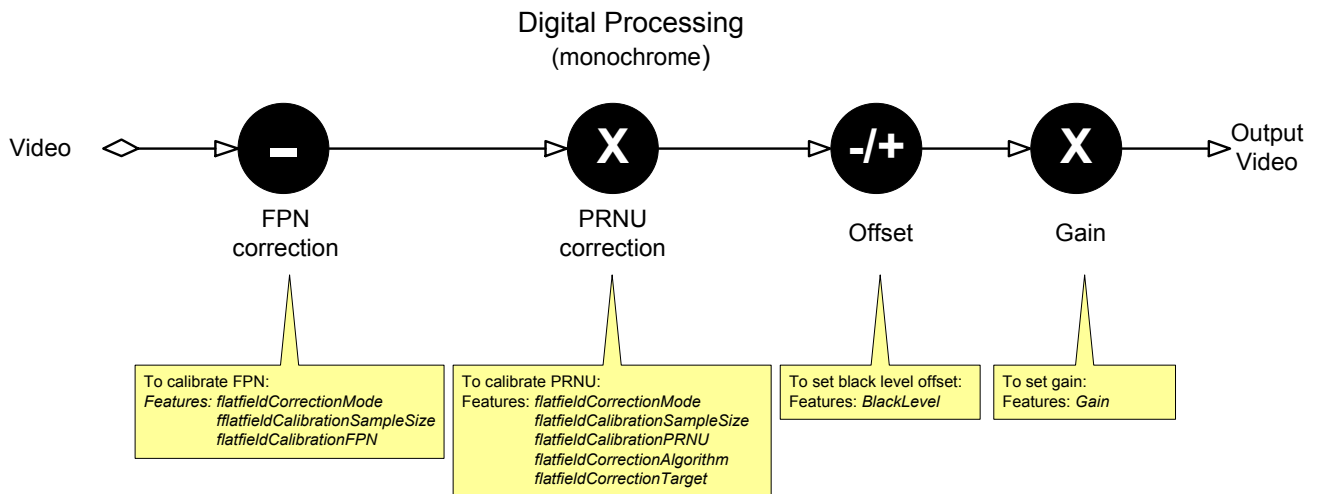

To calibrate the camera's flat field coefficients:

- Configure the camera to the required EXSYNC and exposure timing, and adjust the light level for normal operation. If used, any horizontal or vertical binning should also be applied.
- Set the system gain to a value that best suits the application; refer to the section Gain and Black Level (Offset) for more information on setting these values.
- The lens should be at the required magnification and aperture and slightly unfocused to avoid introducing granularity or details in the reference image (when calibration is complete, refocus the lens).
- As the white reference is located at the object plane, any markings or contaminants on its surface (that is, dust, scratches, smudges) will end up in the calibration profile of the camera. To avoid this, use a clean white plastic or ceramic material rather than trying to rely on a paper reference. (Ideally, the white object will be moving during the calibration process, as the averaging process of the camera will diminish the effects of any small variation in the white reference.)
- Adjust the system gain until the peak intensity is at the desired DN level and then calibrate the fixed pattern noise (FPN). Use a lens cap to ensure that no light reaches the sensor.
- Once complete, remove the lens cap and perform a photo response non-uniformity (PRNU) calibration using the desired target value (in DN). You want all the pixels to match. This target value should be higher than the peak values you saw while first setting up the camera.

- After several seconds the PRNU calibration will end and the correction coefficients will be enabled. The system gain remains as first set.
- The coefficients and gain parameters, timing and control configuration can be stored in any one of eight user sets and automatically retrieved at power-up or by user selection.



CamExpert has a default timeout of 20 seconds per command, which is too short for the FFC calibration to run fully. You can change the default timeout by setting a command line argument in the short-cut:

- Right-click on the short-cut in the start menu and select Properties.
- In the Target field, add the switch **-timeout 60** (See below)
This increases the command timeout to 60 seconds.
Note that you must include a character space between the closing quotation mark in the target and the hyphen before the timeout value.
- Repeat for desktop short-cut

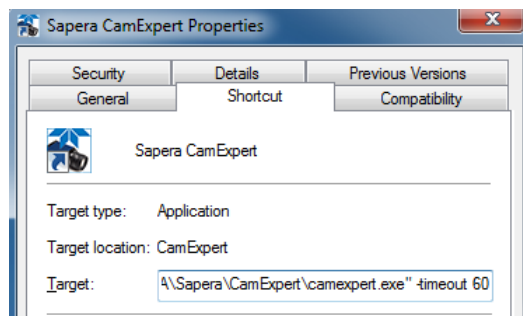

Flat Field Parameters

This **Flat Field** category contains a number of features that are used to correct image distortion due to lens vignetting and uneven illumination.

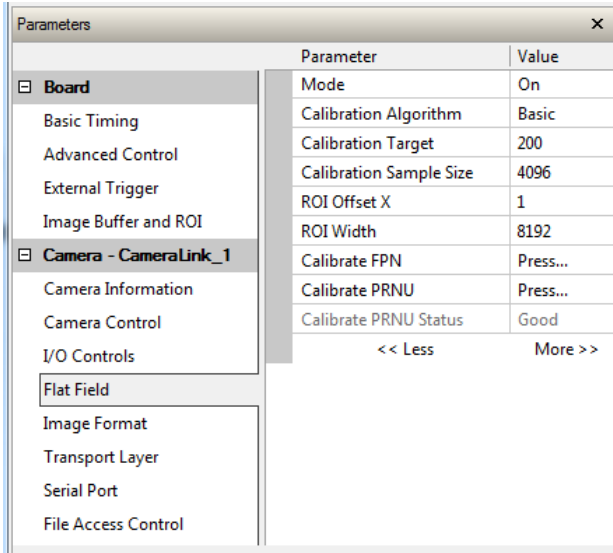

Flat Field	
Parameter	Description
Mode	<p>Off – Flat field correction coefficients are not applied.</p> <p>On – Flat field correction coefficients are applied.</p> <p>Initialize – Sending this value will reset all current coefficients (offsets to 0 and gains to 1x).</p>
Calibration Algorithm	<p>Basic – Direct calculation of coefficients based on current average line values and target.</p>
Calibration Target	<p>After calibration all pixels will be scaled to output this level.</p> <p>Range depends on pixel format:</p> <ul style="list-style-type: none"> • 8-bit: 0 to 255 DN • 12-bit: 0 to 4095 DN
Calibration Sample Size	<p>Number of lines to average when calibrating.</p> <p>Possible values: 2048 or 4096</p>
ROI Offset X	<p>Together with "ROI Width", specifies the range of pixels to be calibrated. Pixel coefficients outside this range are not changed. It is possible to calibrate different regions sequentially.</p>
ROI Width	<p>Width of ROI, in pixels.</p>
Calibration FPN	<p>Save average line (of "Calibration Sample Size" rows). This is the first user correction applied – it is subtracted from each line.</p> <p>This feature may not be of use to many users as the camera already subtracts true "dark current", but it may be useful for some to provide a per pixel offset correction.</p>

	<ul style="list-style-type: none"> • Range 0 to 511 DN (12-bit) or 0 to 31 DN (8-bit) • Default value is 0 DN for each pixel
Calibration PRNU	Use "Correction Algorithm" to calculate the per pixel gain to achieve the specified target output. <ul style="list-style-type: none"> • Range 0 to 15.9998x • Default 1x

Gain and Black Level (Offset)

The gain and black level controls can make small compensations to the acquisition in situations where lighting varies and the lens iris cannot be easily adjusted. Optimal gain and black level adjustments maximizes the camera's dynamic range for individual imaging situations.

Use the Offset and Gain features to maximize the use of the output dynamic range (especially when pixel format is less than 12-bits). Typical use is to subtract minimum pixel value expected and then adjust the gain to up the maximum pixel value to approach full scale.

Features and limitations are described below.

- **Black Level** offset is expressed as a digital number providing a \pm offset from the factory setting. The factory setting optimized the black level offset for maximum dynamic range under controlled ideal dark conditions.
- **Digital Gain** is expressed as a multiplication factor. Note that increasing digital gain does not increase the low level resolution and increases the sensor noise proportionately.

A histogram or line profile (available in CamExpert) can provide useful information to determine the optimal settings for the typical image expected for an application. For example, the following histograms illustrate the effect of offset and gain applied to the original image to try to maximize the dynamic range.

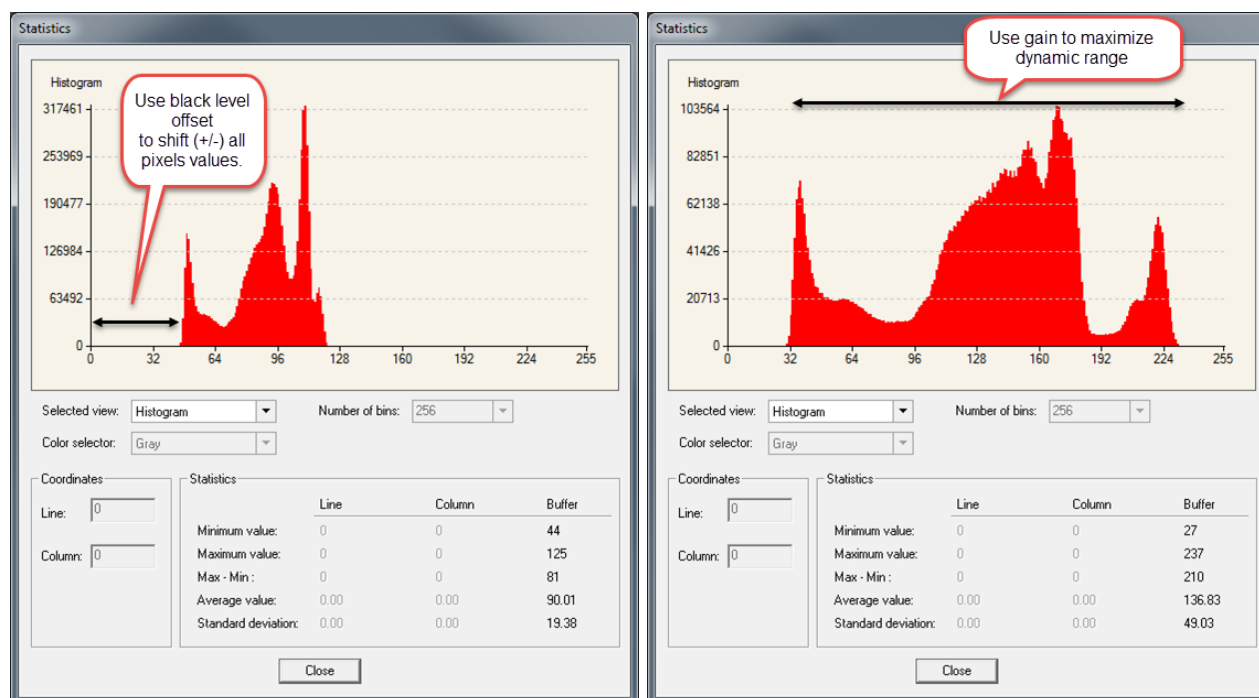

The parameters that control gain and black level are grouped together in the **Camera Control** category:

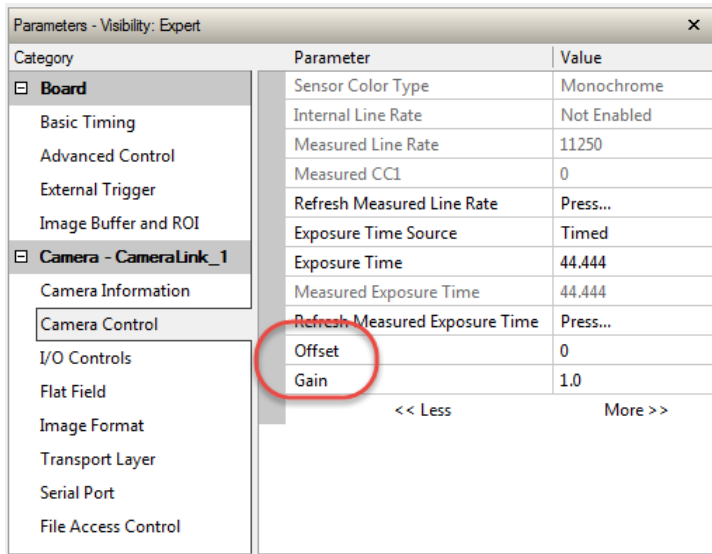

Camera Control				
Offset	Single value added to each pixel. Apply a digital addition after an FPN correction: $\pm 1/8$ of available range. Positive values may be used to measure dark noise.			
	Depending on the the pixel format, different offset ranges are available:			
	<table border="1"> <tr> <td>12-bit mode</td> <td>available range is -512 to +511.</td> </tr> <tr> <td>8-bit mode</td> <td>available range is -32 to +31.</td> </tr> </table>	12-bit mode	available range is -512 to +511.	8-bit mode
12-bit mode	available range is -512 to +511.			
8-bit mode	available range is -32 to +31.			
Gain	Floating point digital multiplier applied to each pixel. Set the gain as an amplification factor applied to the video signal across all pixels: 1x to 10x.			

Trigger Modes

The camera’s image exposures are initiated by a trigger event. The trigger event is either a programmable internal signal used in free running mode, an external input used for synchronizing exposures to external triggers, or a programmed function call message by the controlling computer. These triggering modes are described below.



Note: The Trigger Mode feature can only be adjusted when the Exposure Time Source parameter is set to “Timed”.

The Trigger Mode feature is available in the camera’s **I/O Controls** category:

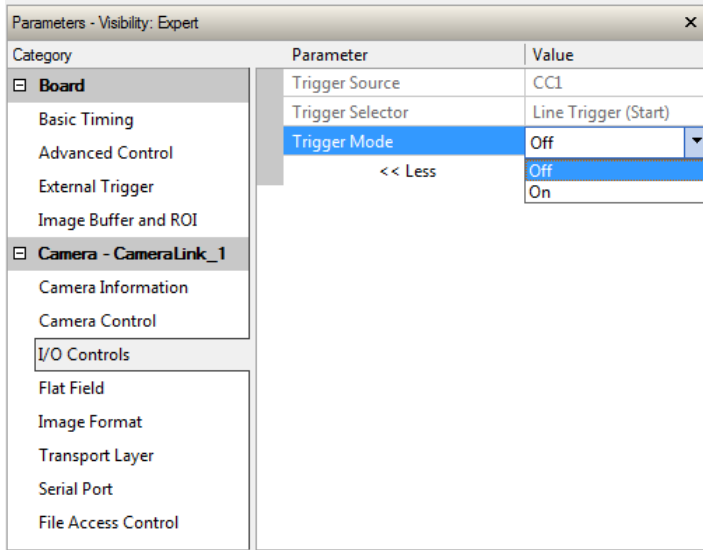

I/O Controls	
Parameter	Description
Trigger Mode	<ul style="list-style-type: none"> • Off: Internal trigger (trigger disabled): The camera free-running mode has a programmable internal timer for line rate and a programmable exposure period. • On: External trigger (trigger enabled): Exposures are controlled by an external trigger signal. The external trigger signal is the Camera Link control line CC1.

Exposure Controls

Exposure control is defined as the start of exposure and exposure duration. Exposure control modes define the method and timing of controlling the sensor integration period. The integration period is the amount of time the sensor is exposed to incoming light before the video line data is transmitted to the controlling computer.

The camera can grab images in one of three ways, as described in the following table:

Description	Line Rate	Exposure Time	Trigger Source
Internal Programmable Exposure	Internal, programmable	Internal programmable	Internal
External Programmable Exposure	Controlled by EXSYNC pulse	Internal programmable	External
External Trigger Width Exposure	Controlled by EXSYNC pulse	External (EXSYNC)	External

You determine the three imaging modes using a combination of the Exposure Time Source parameters (including I/O parameters), Exposure Time and Internal Line Rate parameters.

- The feature **Exposure Time Source** selects the controlling method for the exposure.
- The start of exposure can be driven by an internal timer signal, an external trigger signal, or a software function call.
- For External Trigger signals, the relationship between an external line trigger and the exposure period is only applicable while the external line trigger does not exceed the maximum allowable line rate.
- If the external line rate exceeds the maximum line rate allowed for a mode, the camera will continue to output data at its maximum line rate. Though no image artifacts associated with over-speed will occur, you may notice that under over-speed conditions the image will appear compressed and the apparent distance travelled will be reduced.

The relevant exposure control features are grouped in the Camera Control category:

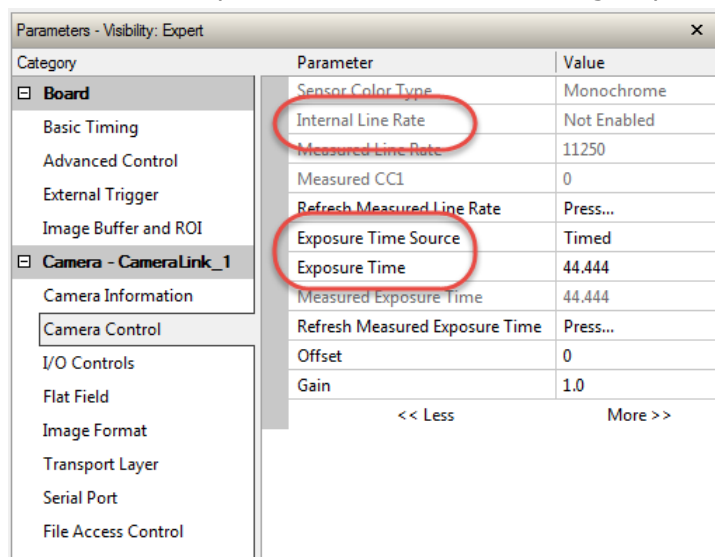

Camera Control		
Parameter	Description	
Internal Line Rate	Camera line rate in a range from 300 Hz up to 71 kHz. This feature is only available when the camera is in Internal Mode (free running): that is, the line trigger is disabled (Trigger Mode off).	
Exposure Time Source	Set the operation mode for the camera's exposure. Trigger Width is only available when Trigger Mode is enabled.	
	<i>Trigger Width</i>	Uses the width of the current line trigger signal pulse to control the exposure duration.
	<i>Timed</i>	The exposure duration time is set using the Exposure Time feature and the exposure starts with the Line Start event.
Exposure Time	Sets the exposure time (in microseconds). Exposure Time Source feature must be set to Timed.	

Internal Programmable Exposure

The camera in the Internal Programmable Exposure mode is the default free- running mode with the external trigger off and internal exposure control. This mode is not synchronized to an external signal. Line rate is the dominant factor when adjusting the line rate or exposure time. When setting the line rate exposure time will decrease (if necessary) to accommodate the new line rate. When adjusting the exposure time the range is limited by the line rate and has the following features:

- The *Trigger Source* feature (see I/O Control category) selects an internal signal as trigger.
- Programmable internal trigger, where the maximum line rate limit is related to the *Exposure Time* feature.
- Exposure duration is user programmable (exposure maximum is dependent on the line rate). Minimum exposure (in μs) is model dependent.

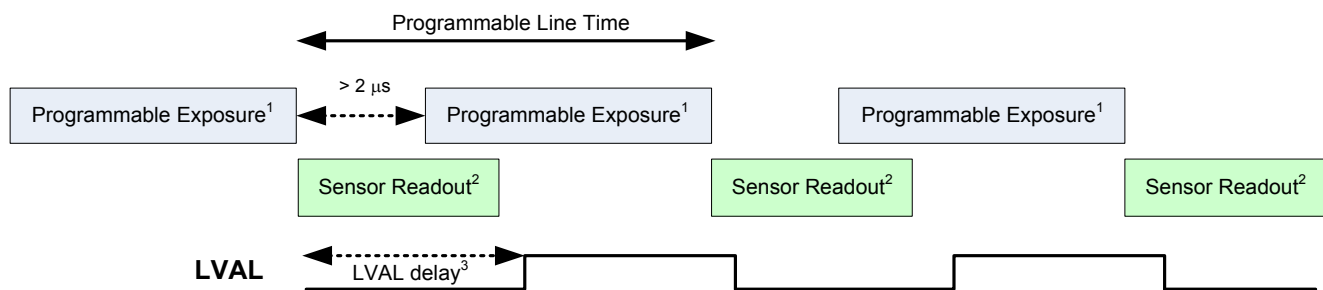

1. Exposure time $> 4\mu\text{s}$
2. Sensor readout time = $14.1\mu\text{s}$
3. LVAL delay = $37\mu\text{s}$

To calculate the maximum line rate:

$$\text{Maximum line rate} = \frac{1}{(\text{exposure time} + \text{low time}^*)}$$

*Exposure time must be greater than $4\mu\text{s}$, and low time greater than greater than $2\mu\text{s}$ (16k model)

GenICam parameters to set:

- I / O Controls > Trigger Mode > Off
- Camera Control > Internal Line Rate > *user value*
- Camera Control > Exposure Time > *user value*

External Programmable Exposure

The External Programmable Exposure mode is similar to Internal Programmable except for the exposure start being an external user input.

- The TriggerSource feature (see I/O Control category) selects an external signal line as trigger.
- Line rates and exposure limits are as defined for Internal Programmable Exposure.
- The falling edge of the EXSYNC (CC1) signal triggers the start of the internal exposure.

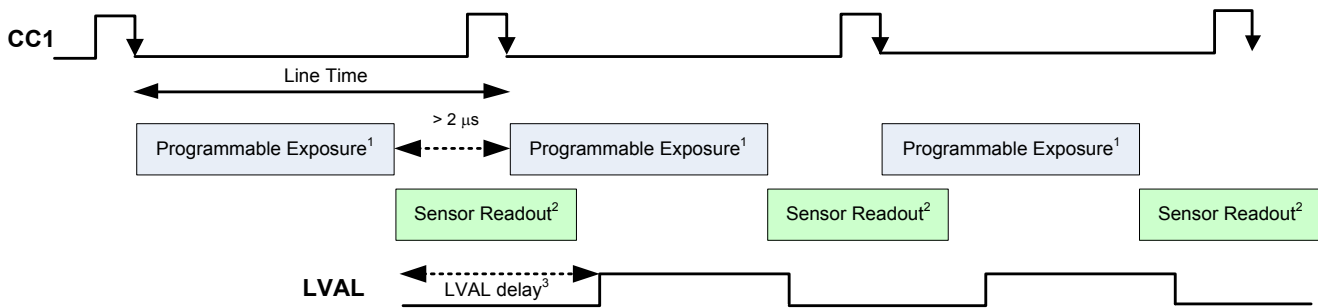

1. Exposure time > 4 μs
2. Sensor readout time = 14.1 μs
3. LVAL delay = 37 μs

GenICam parameters to set:

- I / O Controls > Trigger Mode > On
- Camera Control > Exposure Time Source > Timed
- Camera Control > Exposure Time > *user value*

External Trigger Width Exposure

An alternative external trigger mode allows the external signal width to control the exposure duration. Line readout time remains similar to programmable exposure modes.

- EXSYNC (CC1) sets both the line period and the exposure time.
- The EXSYNC high duration sets the exposure time and the falling edge triggers the start of exposure.

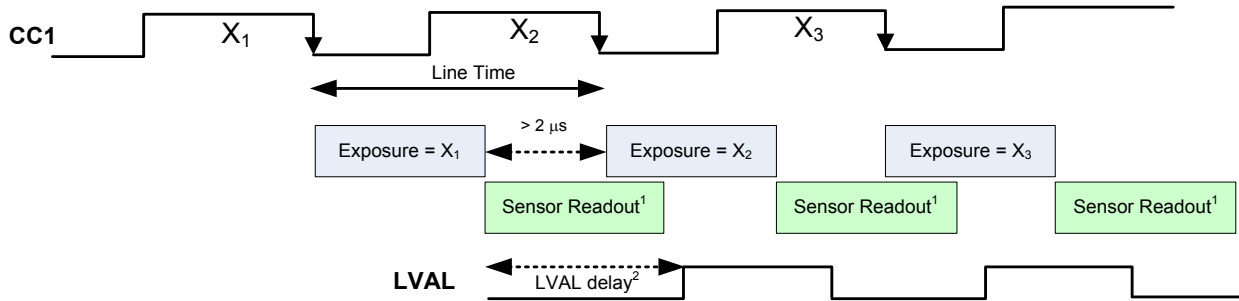

1. Sensor readout time = 14.1 μs
2. LVAL delay = 37 μs

Note:

$$\text{Maximum line rate} = \frac{1}{(\text{exposure time} + \text{low time}^*)}$$

*Exposure time must be greater than 4 μs , and low time greater than 2 μs



Warning! When running external line rate and external exposure time, the line rate must not exceed $1 / (\text{exposure time} + \text{low time})$. Under these conditions the exposure time will become indeterminate and result in image artifacts. This is not the case when running internal exposure control.

GenICam parameters to set:

- I / O Controls > Trigger Mode > On
- Camera Control > Exposure Time Source > Trigger Width

Binning

Binning is the combining of two or more image sensor pixels to form a new combined pixel. A binned image using the same exposure settings as a non-binned image will show an improved signal-to-noise ratio, reduced scanning times (due to lower spatial resolution) and save as a smaller image file size compared with a non-binned image, at the expense of lower image resolution.

In 2 x 2 binning, 4 physical pixels on the sensor are combined into one image pixel. This operating mode is ideal for applications that require faster acquisition and processing times and require greater signal collection.

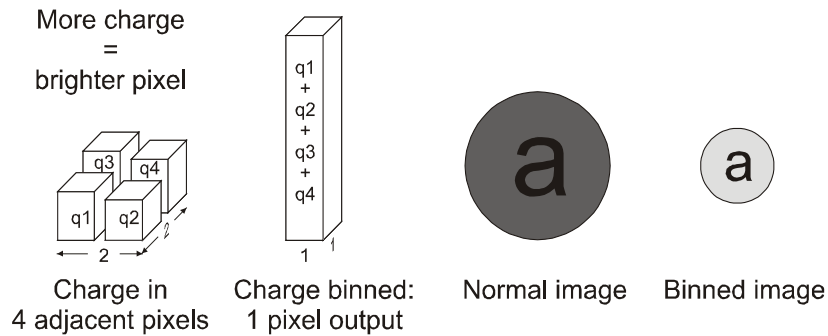

For this camera, the default binning value is 1 x 1,

The **Vertical Binning** and **Horizontal Binning** features in the **Image Format** category represents the number of horizontal pixels that will be combined (added) together.

To change the binning mode you must *first* stop image acquisition in the Acquisition and Transfer Control category.

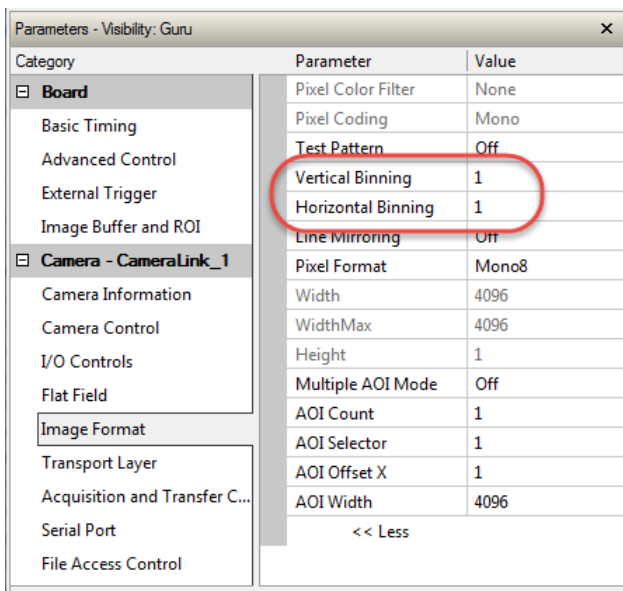

Image Format	
Parameter	Description
Vertical Binning	This feature represents the number of vertical photo-sensitive cells that are combined (added) together: 2.
Horizontal Binning	This feature represents the number of horizontal photo-sensitive cells that are combined (added) together.

Pixel Readout Direction (Mirroring Mode)

The Line Mirroring feature, in the **Image Format** category, sets the tap readout from left to right or from right to left. This feature is especially useful if you want to mount the camera “upside down.”

Image Format	
Parameter	Description
Line Mirroring	Off: All pixels are read out from left to right. On: All pixels are read out from right to left.

Area of Interest (AOI) Setup

The Area of Interest (AOI) feature can be used to reduce the amount of image-data output from the camera. Use this feature when there are areas in the image that contain unneeded information.

An example where you would use this feature is in an application that is inspecting several separated lanes of objects with one camera and the image between the lanes can be ignored.

The AOI feature allows from one to four specific areas of the pixel line to be specified where image data will be output. Since the AOI feature reduces the amount of data output, this has the additional benefit of allowing the cameras to operate at higher line rates when using base or medium camera link modes.

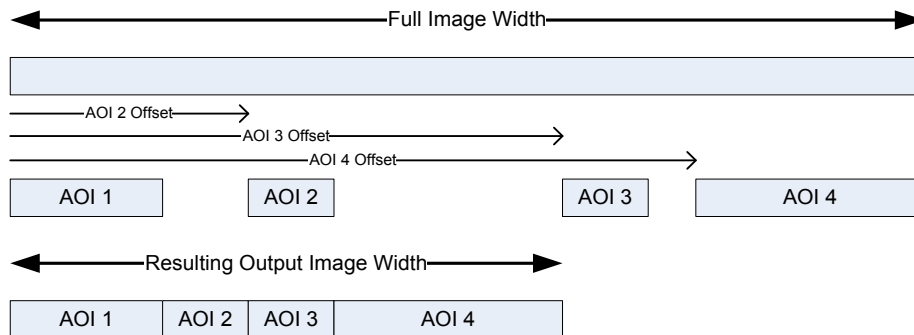

Note: The setup of AOI is always with respect to the sensor. Therefore, if you are using the mirroring mode with AOI, be aware that pixel one will be on the right side of the displayed image.

The AOI commands are grouped in the Image Format category.

To set up an AOI for the camera:

- The AOI mode must first be in the off position.
- Use the AOI Count to select the total number of AOIs desired to a max of 4.
- To set up each AOI individually use the AOI Selector to point to the AOI to be set up.
- AOI Offset X is used indicate the starting pixel of the AOI. The starting pixel of the region must be 1 + a multiple of 8 (base, medium, and full modes) or 10 (deca mode).
- AOI Width is used to indicate the width of the AOI. Minimum region width is 40 pixels and must be a multiple of 8 (base, medium, and full modes) or 10 (deca mode).

Parameters - Visibility: Expert

Category	Parameter	Value	
Board	Pixel Color Filter	None	
	Pixel Coding	Mono	
	Test Pattern	Fixed Value 32(2)	
	Vertical Binning	1	
	Horizontal Binning	2	
	Line Mirroring	Off	
Camera - CameraLink_1	Pixel Format	Mono	
	Width	4096	
	WidthMax	4096	
	Height	1	
	Multiple AOI Mode	Off	
	AOI Count	4	
	AOI Selector	2	
	AOI Offset X	2000	
	AOI Width	500	
	<< Less		

Annotations:

- Must be Off to set up AOIs.
- Set the number of AOIs (1 to 4).
- Select the AOI to adjust its settings.
- Set the starting position of the AOI.
- Set the width of the selected AOI.

To initiate operation of the AOI once setup:

- The AOI mode must be changed to Active.
- Be sure to set the frame grabber image width to the sum of all AOI widths set up in the camera.

Parameters - Visibility: Expert

Category	Parameter	Value
Board	Pixel Color Filter	None
	Pixel Coding	Mono
	Test Pattern	Fixed Value 3...
	Vertical Binning	1
	Horizontal Binning	2
	Line Mirroring	Off
	Pixel Format	Mono8
	Width	4096
	WidthMax	4096
	Height	1
Camera - CameraLink_1	Multiple AOI Mode	Active
	AOI Count	Off
	AOI Selector	Active
	AOI Offset X	2001
	AOI Width	496
	<< Less More >>	

After setup of AOIs is complete, change the mode to Active.

Saving and Restoring Camera Settings

The parameters used to select, load and save user sets are grouped together under the Camera Information category. There are 8 user sets available and 1 factory set.

Camera Configuration Selection Dialog

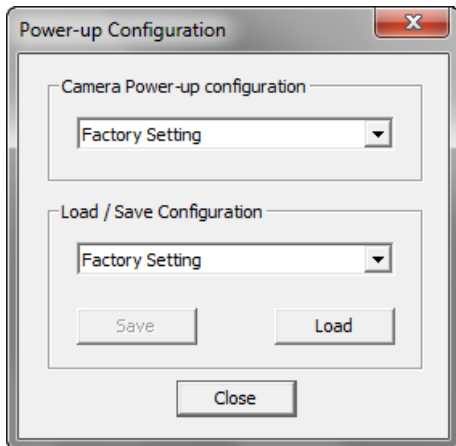

CamExpert provides a dialog box which combines the features to select the camera power-up state and for the user to save or load a camera state from the camera's memory.

Camera Power-up Configuration

Either the Factory or one of the User Settings can be used as the default setting and is the set loaded when the camera is reset or powered up.

The first drop list selects the camera configuration state to load on power-up (see feature *UserSetDefaultSelector*). The user chooses from one factory data set or one of 8 possible user saved states.

User Set Configuration Management

The user setting is the saved set of camera configurations that you can customize, resave, and restore. By default the user settings are shipped with the same settings as the factory set.

The second drop list allows the user to change the camera configuration any time after a power-up (see feature *UserSetSelector*). To reset the camera to the factory configuration, select *Factory Setting* and click Load. To save a current camera configuration, select from User Set 1 through User Set 8, and click Save. Select a saved user set and click Load to restore a saved configuration.

Active Settings for Current Operation

The active setting for the current operation is the set of configurations that are active while the camera is currently running, including all unsaved changes you have made to the settings before saving them.

These active settings are stored in the camera's *volatile* memory and will be lost and cannot be restored if the camera resets, is powered down, or loses power.

To save these settings for reuse the next time you power up or reset the camera, or to protect against losing them in the case of power loss, you must save the current settings. Once saved, the current settings become the selected **User Set**.

User Setting

The command **User Set Save** saves the current settings to non-volatile memory as a **User Set**. The camera automatically restores the last saved user settings when it powers up.

To restore the last saved user settings, select the **User Set** parameter you want to restore and then select the **User Set Load** parameter.

Factory Settings

The factory setting is the camera settings that were shipped with the camera and which loaded during the camera's first power-up. To load or restore the original factory settings, at any time, select the **Factory Setting** parameter and then select the **User Set Load** parameter.



Note: By default, the user settings are set to the factory settings.

Camera Firmware Updates

The user can upload new firmware using the [File Access Control](#) features via Sopera CamExpert.

To update the camera firmware several files must be updated. Files include the following:

Type	File
Device Firmware	Microcode (.hex file)
XML	XML file
Miscellaneous	FPGA Code (.bin file)
	CCI (.hex file)

After all files have been transferred to the camera (the order is not relevant), reboot or reset the camera and restart CamExpert to verify the file versions displayed in the Camera Information category.



Warning! The camera firmware file versions must all be compatible or the camera risks becoming inoperable. **Only after all required files are uploaded to the camera can the camera be reset or rebooted to activate the new firmware.**

Before updating any firmware files verify that the file versions are correct. If in doubt, contact your Teledyne DALSA representative if you have any questions before proceeding.

Download a List of Camera Parameters

For diagnostic purposes you may want to download a list of all the parameters and values associated with the camera. To do this use the [File Access Control](#) features via Spera CamExpert:

- Select "Miscellaneous" file type
- In the "File selector" drop-down box select "CameraData".
- Click "Download".
- Save the text file and send the file to Teledyne DALSA customer support if required.

File Access via the CamExpert Tool

- In the **File Access Control** Category, click on the "Setting..." button to open the File Access Control dialog.

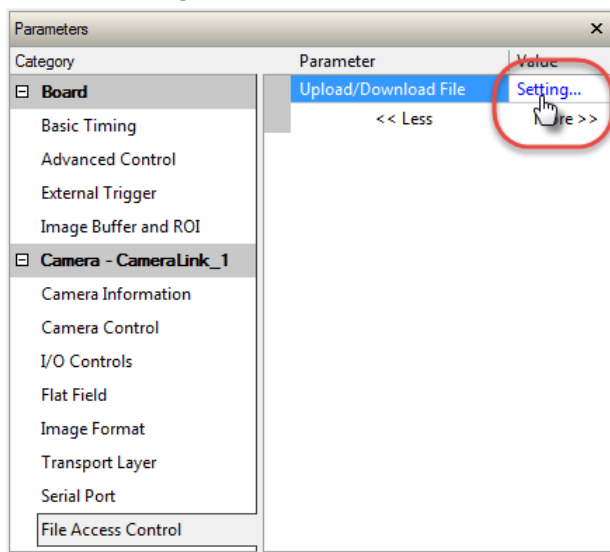

- From the file **Type** drop menu, select the file type that will be uploaded to the camera. This CamExpert tool allows quick firmware changes or updates.

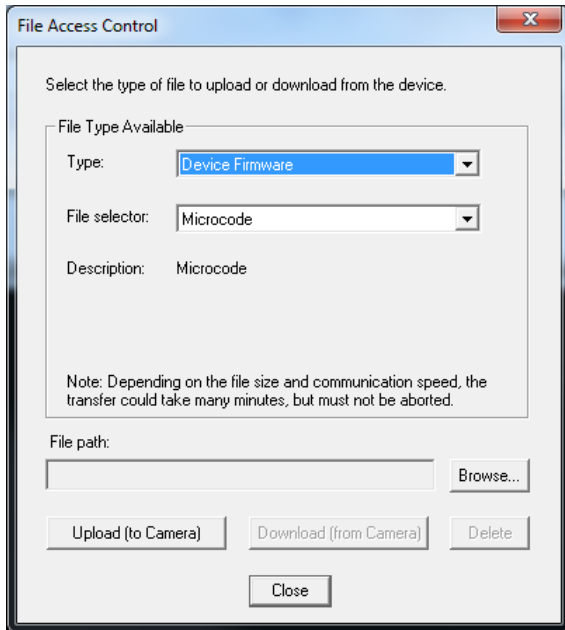

- From the File Selector drop menu, select the camera's memory location for the uploaded data. This menu presents only the applicable data locations for the selected file type.
- Click the Browse button to open a standard Windows Explorer window.
- Select the specific file from the system drive or from a network location.
- Click the Upload button to execute the file transfer to the camera.
- Note that firmware changes require a device reset command from the Transport Layer Controls.

Technical Specifications

Mechanical Specifications

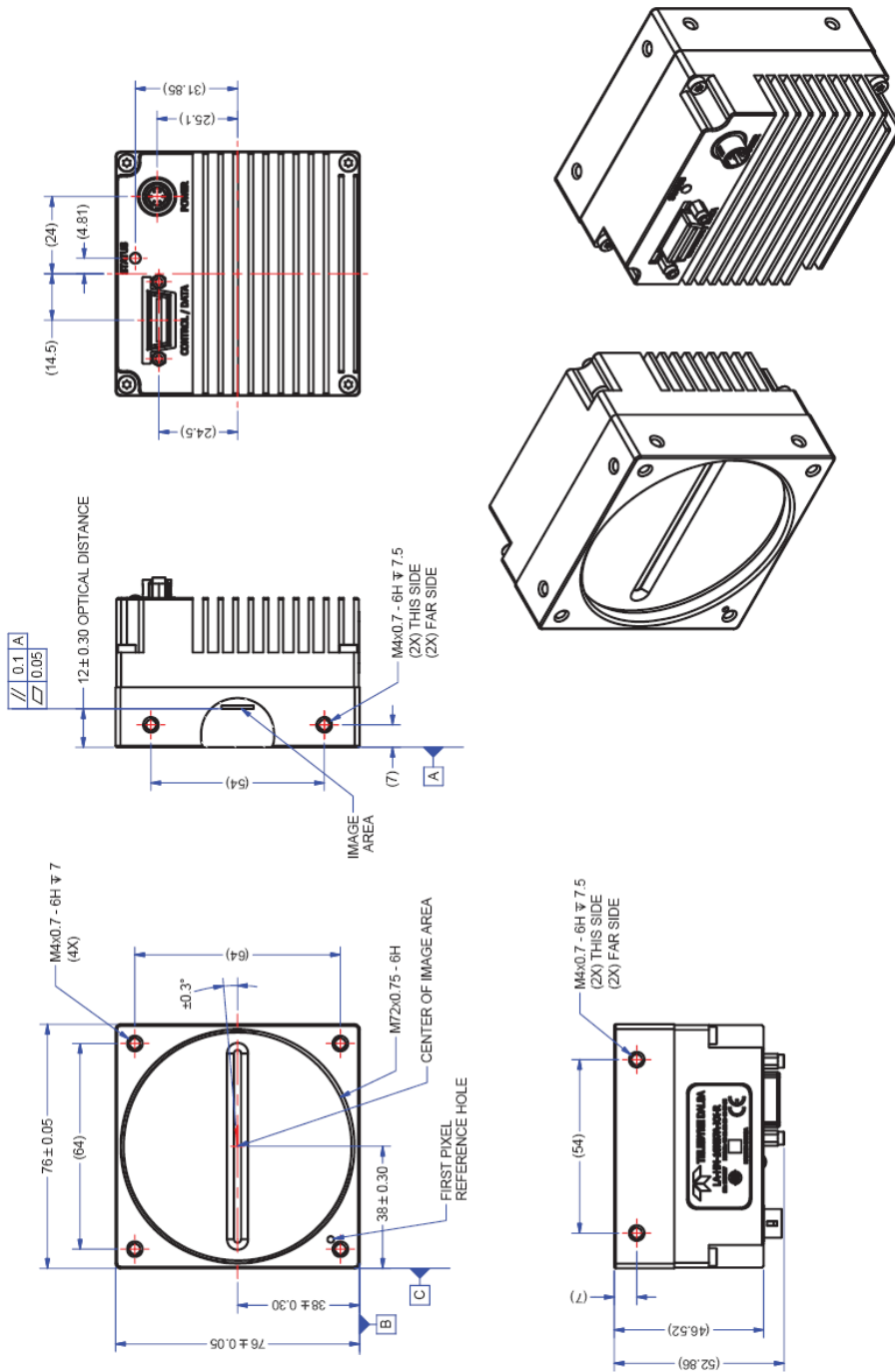

NOTES:
 1. UNITS: MILLIMETERS.
 2. IMAGE AREA IS ALIGNED TO DATUMS A, B & C.

Additional Notes on Linea CLHS Identification and Mechanical

Identification Label



The cameras have an identification label applied to the back side, with the following information:

- Model Part number
- Serial number
- 2D Barcode
- CE and FCC logo
- "Made in Canada" Statement

EMC Declarations of Conformity

We:

Teledyne DALSA inc.
605 McMurray Road,
Waterloo, Ontario, Canada,
N2V 2E9

Declare under sole legal responsibility that the following products conform to the protection requirements of council directive 2004/108/EC (2014/30/EU after April 2016) on the approximation of the laws of member states relating to electromagnetic compatibility and are CE-marked accordingly:

LA-CM-02K08A-00-R (issued 2014-01-20), LA-CM-04K08A-00-R (issued 2014-01-20), LA-CM-08K08A-00-R (issued 2014-12-04), and LA-CM-16K05A-00-R (issued 2015-04-22)

The products to which this declaration relates are in conformity with the following relevant harmonized standards, the reference numbers of which have been published in the Official Journal of the European Communities:

EN55032 (2012)	Electromagnetic compatibility of multimedia equipment — Emission requirements
EN55011 (2009) with A1(2010)	Industrial, scientific and medical equipment — Radio-frequency disturbance characteristics — Limits and methods of measurement
EN 61326-1 (2013)	Electrical equipment for measurement, control and laboratory use — EMC requirements — Part 1: General requirements
EN 55024 (2010)	Information technology equipment — Immunity characteristics — Limits and methods of measurement

Further declare under our sole legal responsibility that the product listed also conforms to the following international standards:

CFR 47	part 15 (2008), subpart B, for a class A product. Limits for digital devices
ICES-003	Information Technology Equipment (ITE) — Limits and Methods of Measurement
CISPR 11	Industrial, scientific and medical equipment - Radio-frequency disturbance characteristics - Limits and methods of measurement
CISPR 32	Electromagnetic compatibility of multimedia equipment - Emission requirements

Note: this product is intended to be a component of a larger system.



Hank Helmond
Director, Quality Assurance
Waterloo, Canada

Additional Reference Information

Optical Considerations

This section provides an overview to illumination, light sources, filters, lens modeling, and lens magnification. Each of these components contribute to the successful design of an imaging solution.

Illumination

The amount and wavelengths of light required to capture useful images depend on the particular application. Factors include the nature, speed, and spectral characteristics of objects being imaged, exposure times, light source characteristics, environmental and acquisition system specifics, and more. The Teledyne DALSA Web site, <http://www.teledynedalsa.com/>, provides an introduction to this potentially complicated issue. Click on Knowledge Center and then select Application Notes and Technology Primers. Review the sections of interest.

It is often more important to consider exposure than illumination. The total amount of energy (which is related to the total number of photons reaching the sensor) is more important than the rate at which it arrives. For example, $5 \mu\text{J}/\text{cm}^2$ can be achieved by exposing $5 \text{ mW}/\text{cm}^2$ for 1 ms just the same as exposing an intensity of $5 \text{ W}/\text{cm}^2$ for $1 \mu\text{s}$.

Light Sources

Keep these guidelines in mind when selecting and setting up light source:

- LED light sources are relatively inexpensive, provide a uniform field, and longer life span compared to other light sources. However, they also require a camera with excellent sensitivity.
- Halogen light sources generally provide very little blue relative to infrared light (IR).
- Fiber-optic light distribution systems generally transmit very little blue relative to IR.
- Some light sources age such that over their life span they produce less light. This aging may not be uniform—a light source may produce progressively less light in some areas of the spectrum but not others.

Lens Modeling

Any lens surrounded by air can be modeled for camera purposes using three primary points: the first and second principal points and the second focal point. The primary points for a lens should be available from the lens data sheet or from the lens manufacturer. Primed quantities denote characteristics of the image side of the lens. That is, h is the object height and h' is the image height.

The focal point is the point at which the image of an infinitely distant object is brought to focus. The effective focal length (f') is the distance from the second principal point to the second focal point. The back focal length (BFL) is the distance from the image side of the lens surface to the second focal point. The object distance (OD) is the distance from the first principal point to the object.

Primary Points in a Lens System

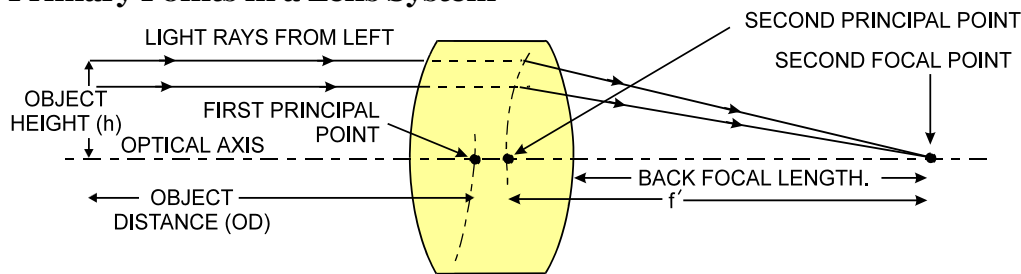

Magnification and Resolution

The magnification of a lens is the ratio of the image size to the object size:

$m = \frac{h'}{h}$	Where m is the magnification, h' is the image height (pixel size) and h is the object height (desired object resolution size).
--------------------	--

By similar triangles, the magnification is alternatively given by:

$m = \frac{f'}{OD}$

These equations can be combined to give their most useful form:

$\frac{h'}{h} = \frac{f'}{OD}$	This is the governing equation for many object and image plane parameters.
--------------------------------	--

Example: An acquisition system has a 512 x 512 element, 10 μ m pixel pitch area scan camera, a lens with an effective focal length of 45mm, and requires that 100 μ m in the object space correspond to each pixel in the image sensor. Using the preceding equation, the object distance must be 450mm (0.450m).

$\frac{10\mu m}{100\mu m} = \frac{45mm}{OD}$	$OD = 450mm(0.450m)$
--	----------------------

Sensor Handling Instructions

This section reviews proper procedures for handling, cleaning, or storing the camera. Specifically the camera sensor needs to be kept clean and away from static discharge to maintain design performance.

Electrostatic Discharge and the Sensor

Cameras sensors containing integrated electronics are susceptible to damage from electrostatic discharge (ESD).

Electrostatic charge introduced to the sensor window surface can induce charge buildup on the underside of the window that cannot be readily dissipated by the dry nitrogen gas in the sensor package cavity. With charge buildup, problems such as higher image lag or a highly non-uniform response may occur. The charge normally dissipates within 24 hours and the sensor returns to normal operation.



Important: Charge buildup will affect the camera's flat-field correction calibration. To avoid an erroneous calibration, ensure that you perform flat-field correction only after a charge buildup has dissipated over 24 hours.

Protecting Against Dust, Oil and Scratches

The sensor window is part of the optical path and should be handled like other optical components, with extreme care.

Dust can obscure pixels, producing dark patches on the sensor response. Dust is most visible when the illumination is collimated. The dark patches shift position as the angle of illumination changes. Dust is normally not visible when the sensor is positioned at the exit port of an integrating sphere, where the illumination is diffuse.

Dust can normally be removed by blowing the window surface using a compressed air blower, unless the dust particles are being held by an electrostatic charge, in which case either an ionized air blower or wet cleaning is necessary.

Oil is usually introduced during handling. Touching the surface of the window barehanded will leave oily residues. Using rubber finger cots and rubber gloves can prevent oil contamination. However, the friction between the rubber and the window may produce electrostatic charge that may damage the sensor. To avoid ESD damage and to avoid introducing oily residues, avoid touching the sensor.

Scratches can be caused by improper handling, cleaning or storage of the camera. When handling or storing the camera without a lens, always install the protective cap. Scratches diffract incident illumination. When exposed to uniform illumination, a sensor with a scratched window will normally have brighter pixels adjacent to darker pixels. The location of these pixels changes with the angle of illumination.

An important note on window blemishes

When flat field correction is performed, window cleanliness is paramount. The figure below shows an example of what can happen if a blemish is present on the sensor window when flat field correction is performed. The blemish will cast a shadow on the wafer. FFC will compensate for this shadow by increasing the gain. Essentially FFC will create a white spot to compensate for the dark spot (shadow). As long as the angle of the incident light remains unchanged then FFC works well. However when the angle of incidence changes significantly (i.e. when a lens is added) then the shadow will shift and FFC will make things worse by not correcting the new shadow (dark spot) and overcorrecting where the shadow used to be (white spot). While the dark spot can be potentially cleaned, the white spot is an FFC artifact that can only be corrected by another FFC calibration.

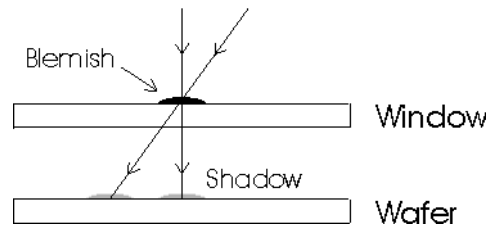

Cleaning the Sensor Window

Even with careful handling, the sensor window may need cleaning. The following steps describe various cleaning techniques to clean minor dust particles to accidental finger touches.

- Use compressed air to blow off loose particles. This step alone is usually sufficient to clean the sensor window. Avoid moving or shaking the compressed air container and use short bursts of air while moving the camera in the air stream. Agitating the container will cause condensation to form in the air stream. Long air bursts will chill the sensor window causing more condensation. Condensation, even when left to dry naturally, will deposit more particles on the sensor.
- When compressed air cannot clean the sensor, Dalsa recommends using lint-free ESD-safe cloth wipers that do not contain particles that can scratch the window. The Anticon Gold 9"x 9" wiper made by Milliken is both ESD safe and suitable for class 100 environments. Another ESD acceptable wiper is the TX4025 from Texwipe.
- An alternative to ESD-safe cloth wipers is Transplex swabs that have desirable ESD properties. There are several varieties available from Texwipe. Do not use regular cotton swabs, since these can introduce static charge to the window surface.
- Wipe the window carefully and slowly when using these products.

Appendix A: GenICam Commands

This appendix lists the available GenICam camera features. Access these features using the CamExpert interface.

Parameters in gray are read only, either always or due to another parameter being disabled. Parameters in black are user set in CamExpert or programmable via an imaging application.

Features listed in the description table but tagged as *Invisible* are typically reserved for Teledyne DALSA Support or third party software usage, and not typically required by end user applications.

Additionally the Standard column will indicate which parameter is a member of the custom DALSA Features Naming Convention (denoted by **DFNC**), versus the GenICam Standard Features Naming Convention (SFNC not shown).

Camera Information Category

Camera information can be retrieved via a controlling application. Parameters such as camera model, firmware version, etc. are read to uniquely identify the connected device. These features are typically read-only. GenICam applications retrieve this information to identify the camera along with its characteristics.

The Camera Information Category groups information specific to the individual camera. In this category the numbers of features shown are identical whether the view is Beginner, Expert, or Guru. Features listed in the description table but tagged as *Invisible* are usually for Teledyne DALSA or third party software usage—not typically needed by end user applications.

Camera Information Feature Descriptions

The following table describes these parameters along with their view attribute.

Display Name	Feature & Values	Description	Standard & View
Vendor	DeviceVendorName	Displays the device vendor name. (RO)	Beginner
Model	DeviceModelName	Displays the device model name. (RO)	Beginner
CCI Version	DeviceVersion	Displays the device version. This tag will also highlight if the firmware is a beta or custom design. (RO)	Beginner
FPGA Version	DeviceManufacturerInfo	This feature provides extended manufacturer information about the device, such as the firmware design type. (RO)	Beginner
Microcode Version	DeviceFirmwareVersion	Displays the currently loaded firmware version number. Firmware files have a unique number and have the .cbf file extension. (RO)	Beginner
Serial Number	DeviceID	Displays the device's factory set camera serial number. (RO)	Beginner
Device User ID	DeviceUserID	Feature to store a user-programmable identifier of up to 15 characters. The default factory setting is the camera serial number. (RW)	Beginner
Power-on User Set	UserSetDefaultSelector	Selects the camera configuration set to load and make active on camera power-up or reset. The camera configuration sets are stored in camera non-volatile memory. (RW)	Beginner
<i>Factory</i>	<i>Factory</i>	Load factory default feature settings.	
<i>UserSet1 to UserSet8</i>	<i>UserSet1</i>	Select the user defined configuration (UserSet1 to UserSet8) as the Power-up Configuration.	
User Set Selector	UserSetSelector	Selects the camera configuration set to load feature settings from or save current feature settings to. The Factory set contains default camera feature settings. User camera configuration sets contain features settings previously saved by the user. (RW)	Beginner
<i>Factory Set</i>	<i>Factory</i>	Select the default camera feature settings saved by the factory.	
<i>User Set 1 to User Set 8</i>	<i>UserSet1</i>	Select the User Defined Configuration space (UserSet1 to UserSet8) to save to or load from features settings previously saved by the user.	
Load User Set	UserSetLoad	Loads the camera configuration set specified by the User Set Selector feature, to the camera and makes it active. (W)	Beginner
Save User Set	UserSetSave	Saves the current camera configuration to the user set specified by the User Set Selector feature. The user sets are located on the camera in non-volatile memory. (W)	Beginner
Power-on Status	deviceBISTStatus	Return the status of the device Built-In Self Test (BIST). Possible return values are device-specific: refer to Appendix C: Error and Warning Messages.	DFNC Beginner
Device Temperature	DeviceTemperature	Displays the device temperature in degrees Celsius	Beginner
Refresh Temperature	refreshTemperature	Gets the current device temperature and refreshes the DeviceTemperature value.	DFNC Beginner
Input Voltage	deviceInputVoltage	Displays the device power input voltage.	DFNC Beginner
Refresh Voltage	refreshVoltage	Gets the current device input voltage and refreshes the deviceInputVoltage value.	DFNC Beginner
LED Color	deviceLEDColor	Displays the current status LED state.	DFNC Beginner
<i>Good</i>	<i>Green</i>	Camera status OK.	
<i>Blink Green</i>	<i>BlinkGreen</i>	Camera is currently powering-up or busy.	
<i>BIST Error</i>	<i>Red</i>	Camera built-in self-test failure.	

Camera Control Category

The camera controls, as shown by CamExpert, groups sensor specific features. This group includes controls for line rate and exposure time.

Camera Control Feature Descriptions

The following table describes these features along with their view attribute:

Display Name	Feature & Values	Description	Standard & View
Sensor Color Type <i>Monochrome</i>	sensorColorType <i>Monochrome</i>	Defines the camera sensor color type. < RO > <i>Sensor color type is monochrome.</i>	Beginner DFNC
Internal Line Rate	AcquisitionLineRate	Specifies the camera internal line rate, in Hz.	Beginner
Measured Line Rate	measureLineRate	Displays the line rate provided to the camera by either internal or external source < RO >	DFNC Beginner
Measured CC1	measureCC1Rate	Displays the CC1 signal rate provided to the camera. <RO>	DFNC Beginner
Refresh measured line rate	refreshMeasureLineRate	Updates the <i>measureLineRate</i> value.	DFNC Beginner
Exposure Time Source <i>Timed</i> <i>Trigger Width</i>	ExposureMode <i>TriggerWidth</i>	Sets the operation mode for the camera's exposure. <i>The exposure duration time is set using the Exposure Time feature and the exposure starts with a LineStart event.</i> <i>Uses the width of the trigger signal pulse to control the exposure duration. Use the Trigger Activation feature to set the polarity of the trigger. The Trigger Width setting is applicable when the LineStart trigger is enabled and a signal is selected as trigger source.</i>	Beginner
Exposure Time	ExposureTime	Sets the exposure time (in microseconds) when the Exposure Mode feature is set to Timed.	Beginner
Measured Exposure Time	measureExposureTime	Displays the exposure time used by the camera sensor.	DFNC Beginner
Refresh Measured Exposure Time	refreshMeasuredExposureTime	Updates the <i>measuredExposureTime</i> value.	DFNC Beginner
Offset	BlackLevel	Analog black level (offset) in DN. Controls the black level as an absolute physical value. This represents a DC offset applied to the video signal.	Beginner
Gain	Gain	Sets the digital gain applied to the image.	Beginner

I/O Control Category

The camera's I/O controls, as shown by CamExpert, group features used to configure external inputs and acquisition actions based on those inputs, plus camera output signals to other devices.

I/O Control Feature Descriptions

The following table describes these features along with their view attribute and minimum camera firmware version required:

Display Name	Feature & Values	Description	Standard & View
Trigger Selector <i>LineStart</i>	TriggerSelector <i>LineStart</i>	Displays the type of trigger to configure with the various Trigger features. <RO> <i>Selects a trigger starting the capture of a single line.</i>	Beginner
Trigger Mode <i>Off</i> <i>On</i>	TriggerMode <i>Off</i> <i>On</i>	Controls the enable state of the selected trigger. <i>The selected trigger is turned off.</i> <i>The selected trigger is turned active.</i>	Beginner

Flat Field Category

The camera's Flat Field controls, as shown by CamExpert, group features used to calibrate the camera's flat field correction coefficients. Parameters in black are user set in CamExpert or programmable via an imaging application.

Flat Field Feature Descriptions

The following table describes these features along with their view attribute:

Display Name	Feature & Values	Description	Standard & View
Mode <i>Off</i> <i>On</i> <i>Initialize</i>	flatfieldCorrectionMode <i>Off</i> <i>On</i> <i>Initialize</i>	Sets the mode for flat field correction. Flat field correction is disabled. Flat field correction is enabled. Reset all FPN coefficients to 0 and all flat field coefficients to 1.	DFNC Beginner
Calibration Algorithm <i>Basic</i> <i>Low Pass Filter</i>	flatfieldCorrectionAlgorithm <i>Basic</i> <i>LowPass</i>	Selects the algorithm to use for calibration of flat field coefficients. <i>Direct calculation of coefficients based on average line values and target value.</i> <i>A low pass filter is first applied to the average line values before calculating the coefficients. Use this algorithm if the calibration target is not uniformly white or it is not possible to defocus the image.</i>	DFNC Beginner
CalibrationTarget	flatfieldCalibrationTarget	Sets the target pixel value for the gain (PRNU) calibration. Ranges are: 8-bit output: 0-255 12-bit output: 0-4095	DFNC Beginner
CalibrationSampleSize <i>2048</i> <i>4096</i>	flatfieldCalibrationSampleSize <i>Lines_2048</i> <i>Lines_4096</i>	Sets the number of line to average during a flat field calibration. <i>Average 2048 lines.</i> <i>Average 4096 lines.</i>	DFNC Beginner

ROI Offset X	flatfieldCalibrationROIOffset	Set the starting point of a region of interest where a flat field calibration will be performed	DFNC Beginner
ROI Width	flatfieldCalibrationROIWidth	Sets the width of the region on interest where a flat field calibration will be performed	DFNC Beginner
Calibrate FPN	flatfieldCalibrationFPN	Initiates the FPN calibration process.	DFNC Beginner
Calibrate PRNU	flatfieldCalibrationPRNU	Initiates the PRNU or Flatfield process.	DFNC Beginner
Calibrate PRNU Status <i>Good Clipping</i> <i>Time Out</i> <i>Too Many Outliers</i>	flatfieldCalibrationPRNUStatus <i>Good Clipping</i> <i>ExsyncTimeOut</i> <i>TooManyOutliers</i>	Returns the PRNU calibration status. Calibration successful. Coefficients are clipped to minimum or maximum value. Calibration failed due to time out. Calibration failed because the image is too noisy.	DFNC Beginner

Image Format Control Category

The camera's Image Format controls, as shown by CamExpert, group parameters used to configure camera pixel format, image cropping, and the binning function. Additionally, a feature control to select and output a camera internal test image simplifies qualifying a camera setup without a lens.

Image Format Control Feature Description

The following table describes these features along with their view attribute:

Display Name	Feature & Values	Description	Standard & View
Pixel Coding <i>Mono</i>	PixelCoding <i>Mono</i>	Output image pixel coding format of the sensor. <RO> Monochrome format.	Beginner
Pixel Color Filter <i>None</i>	PixelColorFilter <i>None</i>	Indicates the type of color filter applied to the image. <RO> No filter applied on the sensor.	Beginner
Test Pattern <i>Off</i> <i>Ramp</i>	TestImageSelector <i>Off</i> <i>Ramp</i>	Selects the type of test image output by the camera. Image is from the camera sensor. Image is filled horizontally with an image that goes from the darkest possible value to the brightest.	Beginner
Vertical Binning	BinningVertical	Number of vertical photo-sensitive cells to combine together. This increases the intensity of the pixels but reduces the vertical resolution of the image.	Beginner
Horizontal Binning	BinningHorizontal	Number of horizontal photo-sensitive cells to combine together. This increases the intensity of the pixels but reduces the horizontal resolution.	Beginner
Line Mirroring <i>Off</i> <i>On</i>	ReverseX <i>Off</i> <i>On</i>	Horizontal image flip function. Video output in normal order Video output in a reverse order	Beginner
Pixel Format <i>Mono8</i> <i>Mono12</i>	PixelFormat <i>Mono8</i> <i>Mono12</i>	Output image pixel coding format of the sensor.. Mono8: Monochrome 8-Bit. Note: Camera Link Full configurations support this format only. Mono12: Monochrome 12-Bit Note: Camera Link Base or Medium configurations can use this format.	Beginner

Width	Width	Width of the Image provided by the device (in pixels).	Beginner
Height	Height	Height of the Image provided by the device (in lines).	Beginner
Multiple AOI Mode	multipleAOIMode	Enable the Multiple AOI (Area of Interest) per image feature. The AOI Count is set by the Multiple AOI Count feature. Single AOI per image. The AOI per image feature is active.	DFNC Expert
		<i>Off</i>	<i>Off</i>
		<i>Active</i>	<i>Active</i>
AOI Count	multipleAOICount	Specifies the number of AOIs (Area of Interest) available for the X axis.	DFNC Expert
AOI Selector	multipleAOISelector	Select an AOI (Area of Interest) when Multiple AOI Mode is enabled. Selector range is from 1 to the MultipleAOICount value.	DFNC Expert
AOI Offset X	multipleAOIOffsetX	Horizontal offset (in pixels) from the origin to the selected AOI (Area of Interest). The offset is set as a multiple of 8 or 10 (deca mode) + 1. The maximum offset is the image width - 40.	DFNC Expert
AOI Width	multipleAOIWidth	Width of the selected AOI (Area of Interest) provided by the device (in pixels). The minimum region width is 40 pixels and must be a multiple of 8 or 10 (deca mode).	DFNC Expert

Transport Layer Category

The camera's Transport Layer, as shown by CamExpert, groups features for camera configuration.

Transport Layer Feature Descriptions

Display Name	Feature	Description	Device Version & View
XML Major Version	DeviceManifestXMLMajorVersion	Together with DeviceManifestXMLMinorVersion specifies the GenICam feature description XML file version (RO)	1.00 Beginner DFNC
XML Minor Version	DeviceManifestXMLMinorVersion	Together with DeviceManifestXMLMajorVersion specifies the GenICam feature description XML file version (RO)	1.00 Beginner DFNC
Refresh GenCP Status	refreshGenCPStatus	Press to return the current status of the GenCP	1.00 Beginner
Last GenCP Status	genCPStatus	If a feature read or write fails then Sopera only returns that it fails – read this feature to get the actual reason for the failure Returns the last error Reading this feature clears it	1.00 Beginner DFNC

CLHS Discovery	clhsDiscovery	Selects between CLHS discovery mode which automatically determines the configuration of the CLHS interface when enabled. When disabled, the frame grabber needs to have the configuration set by the user	1.00 Guru DFNC
Discovery Disabled		CLHS transmitters are enabled immediately on power up	
Discovery Enabled		CLHS transmitters enable after sending Acquisition start	
Next CLHS Device Configuration	clhsNext DeviceConfig	When the camera is next powered up, the specified CLHS lane configuration will be set for the camera.	1.00 Guru DFNC
One cable seven lanes			
One cable four lanes			
One cable one lanes			
Two cable seven lanes			
Two cable four lanes			
Two cable one lanes			
CLHS 8b/10b Receive Error Count selector	clhsErrorCountSelector	Selects the error count that the following three features apply to	1.00 Guru DFNC
Data 2 Receive Error Count			
Control/Data1 Receive Error Count			
CLHS 8b/10b Receive Error Count	clhsError Count	CLHS error count value for the selected data/control lanes (RO)	1.00 Guru DFNC
Refresh CLHS 8b/10b Receive Error Count	clhsError CountRefresh	When pressed, the error count is updated	1.00 Guru DFNC
Reset Receive Error Count	clhsErrorCountReset	When pressed, the error count is rest to zero	1.00 Guru DFNC

Device Streaming Registers

Start – End Command Requirements



Important: Every start command must have a corresponding end command. If not the camera can be in an unpredictable state. This pertains to *DeviceRegistersStreamingStart*, *DeviceRegistersStreamingEnd*, *DeviceFeaturePersistenceStart*, and *DeviceFeaturePersistenceEnd*.

Display Name	Feature & Values	Description	Standard & View
Device Registers Streaming Start	DeviceRegistersStreamingStart	Announces the start of registers streaming without immediate checking for consistency.	Invisible
Device Registers Streaming End	DeviceRegistersStreamingEnd	Announces end of registers streaming and performs validation for registers consistency before activating them.	Invisible
Device Feature Streaming Start	DeviceFeaturePersistenceStart	Announces the start of feature streaming without immediate checking for consistency.	Invisible
Device Feature Streaming End	DeviceFeaturePersistenceEnd	Announces end of feature streaming and performs validation for feature consistency before activating them.	Invisible
Register Check	DeviceRegistersCheck	Performs an explicit register set validation for consistency.	Invisible
Registers Valid	DeviceRegistersValid	States if the current register set is valid and consistent.	Invisible

File Access Control Category

The File Access control in CamExpert allows the user to quickly upload various data files to the connected camera. The supported data files are for camera firmware updates and Flat Field coefficients.

Features listed in the description table but tagged as *Invisible* are usually for Teledyne DALSA or third party software usage—not typically needed by end user applications.

File Access Control Feature Descriptions

Display Name	Feature & Values	Description	Standard & View
File Selector	FileSelector	Selects the file to access. The file types which are accessible are device-dependent.	Guru
<i>FPGA Code</i>	<i>FPGA_Code</i>	Upload new FPGA to the camera which will execute on the next camera reboot cycle.	
<i>MicroCode</i>	<i>MicroCode</i>	Upload new micro code to the camera which will execute on the next camera reboot cycle.	
<i>CCI</i>	<i>CCI</i>	Upload new CCI to the camera which will execute on the next camera reboot cycle.	
<i>XML</i>	<i>XML</i>	Upload new XML to the camera which will execute on the next camera reboot cycle.	

<i>User Set</i>	<i>User_Set</i>	Use UserSetSelector to specify which user set to access.	
<i>Flat Field</i>	<i>Flat_Field</i>	Use UserSetSelector to specify which user flatfield to access.	
<i>User FPN</i>	<i>User_FPN</i>	Use UserSetSelector to specify which user FPN to access.	
<i>CameraData</i>	<i>Camera_Data</i>	Download camera information and send for customer support.	
File Operation Selector	FileOperationSelector	Selects the target operation for the selected file in the device. This operation is executed when the File Operation Execute feature is called.	Guru
<i>Open</i>	<i>Open</i>	Select the Open operation - executed by FileOperationExecute.	
<i>Close</i>	<i>Close</i>	Select the Close operation - executed by FileOperationExecute	
<i>Read</i>	<i>Read</i>	Select the Read operation - executed by FileOperationExecute.	
<i>Write</i>	<i>Write</i>	Select the Write operation - executed by FileOperationExecute.	
<i>Delete</i>	<i>Delete</i>	Select the Delete operation - executed by FileOperationExecute.	
File Operation Execute	FileOperationExecute	Executes the operation selected by File Operation Selector on the selected file.	Guru
File Open Mode	FileOpenMode	Selects the access mode used to open a file on the device.	Guru
<i>Read</i>	<i>Read</i>	Select READ only open mode	
<i>Write</i>	<i>Write</i>	Select WRITE only open mode	
File Access Buffer	FileAccessBuffer	Defines the intermediate access buffer that allows the exchange of data between the device file storage and the application.	Guru
File Access Offset	FileAccessOffset	Controls the mapping offset between the device file storage and the file access buffer.	Guru
File Access Length	FileAccessLength	Controls the mapping length between the device file storage and the file access buffer.	Guru
File Operation Status	FileOperationStatus	Displays the file operation execution status. (RO)	Guru
<i>Success</i>	<i>Success</i>	The last file operation has completed successfully.	
<i>Failure</i>	<i>Failure</i>	The last file operation has completed unsuccessfully for an unknown reason.	
<i>File Unavailable</i>	<i>FileUnavailable</i>	The last file operation has completed unsuccessfully because the file is currently unavailable.	
<i>File Invalid</i>	<i>FileInvalid</i>	The last file operation has completed unsuccessfully because the selected file is not present in this camera model.	
File Operation Result	FileOperationResult	Displays the file operation result. For Read or Write operations, the number of successfully read/written bytes is returned. (RO)	Guru
File Size	FileSize	Represents the size of the selected file in bytes.	Guru

Appendix C: Error and Warning Messages

BiST: Built in Self Test

The BiST error flags are binary flags with each bit being independent from each other. The message from the BiST should be "Good" meaning everything is functioning correctly but if a hardware failure does occur in the camera one or more these flags could be set. Any of these errors will result in the status light turning red.

Definition	BiST Flag
I2C error	1
Unable to configure fpga	10
Unable to configure fpga	100
EXT_SRAM Failure	1000
ECHO_BACK Failure	1,0000
FLASH_TIMEOUT	10,0000
FLASH_ERROR	100,0000
NO_FPGA_Code	1000,0000
NO_COMMON_SETTINGS	1,0000,0000
NO_FACTORY_SETTINGS	10,0000,0000
NO_USER_SETTINGS	100,0000,0000
NO_FLAT_FIELD Corrections	1000,0000,0000
NO MISC corrections	1,0000,0000,0000
NO_FPN Correction	10,0000,0000,0000
NO_FPN Correction	100,0000,0000,0000
NO_PRNU Correction	1000,0000,0000,0000
NO_FEED Through Correction	1,0000,0000,0000,0000
NO_LINEARITY Correction	10,0000,0000,0000,0000
SYNC_ERROR	100,0000,0000,0000,0000
OVER_TEMPERATURE	1000,0000,0000,0000,0000
SPI Failure	1,0000,0000,0000,0000,0000
NO_USER_FPN	10,0000,0000,0000,0000,0000
PLL_LOCK_FAILED	100,0000,0000,0000,0000,0000
INVALID_CCI	1000,0000,0000,0000,0000,0000
No LUT	1,0000,0000,0000,0000,0000,0000
Incompatible FPGA code	10,0000,0000,0000,0000,0000,0000

Operational Error Codes

Code	Description
0X8002	Invalid Parameter
0xC01C	CPA_TOO_MANY_OUTLIERS
0x401E	USER_FPN_CLIPPING
0x401F	FLAT_FIELD_CLIPPING

Document Revision History

Revision	Description	Date
00	Preliminary release.	December 12, 2016
01	<ul style="list-style-type: none">Heat sink accessory (AC-MS-00115-xx-R) added to specifications table, page 5.Camera Link HS connector information revised, page 6.Flash memory table added to camera specifications, page 8.Temperature and mounting warning added, page 11.Hirose power connector diagram updated, page 12.Note added to pixel format and binning description to first stop image acquisition, page 23 and 34.Test image description updated, page 24.Timing diagrams: sensor readout time and LVAL delay updated, page 32.	March 20, 2017