

user manual

pco.edge cameras with USB 3.0, Camera Link, CLHS FOL

pco.edge 3.1

pco.edge 4.2

pco.edge 4.2 LT

pco.edge 5.5



pco.edge 3.1 USB

pco.edge 4.2 LT USB

pco.edge 4.2 USB

pco.edge 4.2 Camera Link

pco.edge 4.2 CLHS FOL

pco.edge 5.5 USB

pco.edge 5.5 Camera Link

pco.edge 5.5 CLHS FOL

pco.

An Excelitas Technologies Brand

PCO asks you to read this manual carefully before using the pco.edge camera system and follow the instructions.

Contact us for further questions or comments.



telephone	+49 (0) 9441 2005 50
fax	+49 (0) 9441 2005 20
email	info@pco.de
postal address	Excelitas PCO GmbH Donaupark 11 93309 Kelheim, Germany

The cover picture shows a typical pco.edge camera with Camera Link HS interface.
The lens is sold separately.

Copyright © 2022 Excelitas PCO GmbH (called PCO hereinafter), Kelheim, Germany. All rights reserved. PCO assumes no responsibility for errors or omissions in these materials. These materials are provided as is without warranty of any kind, either expressed or implied, including but not limited to, the implied warranties of merchantability, fitness for a particular purpose, or non-infringement. PCO further does not warrant the accuracy or completeness of the information, text, graphics, links or other items contained within these materials. PCO shall not be liable for any special, indirect, incidental, or consequential damages, including without limitation, lost revenues or lost profits, which may result from the use of these materials. The information is subject to change without notice and does not represent a commitment on the part of PCO in the future. PCO hereby authorizes you to copy documents for non – commercial use within your organization only. In consideration of this authorization, you agree that any copy of these documents, which you make, shall retain all copyright and other proprietary notices contained herein. Each individual document published by PCO may contain other proprietary notices and copyright information relating to that individual document. Nothing contained herein shall be construed as conferring by implication or otherwise any license or right under any patent or trademark of PCO or any third party. Except as expressly provided, above nothing contained herein shall be construed as conferring any license or right under any PCO copyright. Note that any product, process, or technology in this document may be the subject of other intellectual property rights reserved by PCO, and may not be licensed hereunder.

Released: July 2022 © Excelitas PCO GmbH

pco.edge 3.1/4.2/5.5 user manual V2.27 © Excelitas PCO GmbH, Germany

TABLE OF CONTENTS

1. INTRODUCTION	5
1.1 INTENDED USE	5
1.2 DATA OVERVIEW	6
2. SAFETY INSTRUCTIONS	7
3. SYSTEM COMPONENTS	8
4. INSTALLATION	9
4.1 DRIVER	9
4.2 CAMWARE	10
5. QUICK START	11
5.1 PREPARATION	11
5.2 START	11
5.3 FIRST IMAGE	12
6. SHUTTER MODES	13
6.1 ROLLING SHUTTER	13
6.2 GLOBAL SHUTTER	17
6.3 GLOBAL RESET	20
7. CAMWARE 4 SOFTWARE	22
7.1 HARDWARE IO CONTROL	22
7.2 SHUTTER MODE SETUP	24
7.3 REGION OF INTEREST (ROI)	25
APPENDIX	26
A1 TECHNICAL DATA	27
A1.1 DATA SHEET	27
A1.2 MECHANICAL DIMENSIONS	28
A1.2.1 CAMERA LINK VERSION	28
A1.2.2 USB VERSION	29
A1.2.3 CAMERA LINK HS VERSION	29
A1.2.4 WATER-COOLED STANDARD VERSION	30
A1.3 MOUNTING	33
A1.3.5 INSTABLE MOUNTING	33
A1.3.6 CORRECT MOUNTING	33
A1.3.7 COOLING	34
A1.4 REAR PANEL	31
A2 F-MOUNT ADAPTER	33
A2.1 PCO F-MOUNT ADAPTER	33
A2.2 CHANGE FROM F-MOUNT TO C-MOUNT	36
A3 WATER COOLING OPTION PCO.AQUAMATIC II	37
A3.1 SYSTEM COMPONENTS	37
A3.2 FIRST TIME INSTALLATION	38
A3.3 OPERATION	39
A3.4 DIMENSIONS	40
A3.5 YOUR OWN COOLING SYSTEM	40
A4 INTERFACES	41
A4.1 CABLING	41
A4.2 CAMERA LINK	42
A4.2.1 FRAME GRABBER INSTALLATION	42
A4.2.2 MICRO DIAGNOSTICS TOOL	43

A4.3 CAMERA LINK HS INTERFACE	44
A4.3.3 CABLING	44
A4.3.4 SYSTEM REQUIREMENTS	44
A4.3.5 SAFETY INSTRUCTIONS	44
A4.3.6 FRAME GRABBER INSTALLATION	45
A4.3.7 VISION POINT SOFTWARE	46
A4.3.8 UPDATE FIRMWARE OF THE GRABBER	47
A4.4 USB 3.0	48
A4.4.1 DRIVER INSTALLATION	48
A4.4.2 USB 3.0 CARD INSTALLATION	48
A4.4.3 RING BUFFER AND FIFO	50
A5 BINNING WITH CMOS SENSORS	51
A6 LIGHTSHEET SCANNING MODE	52
A7 IMAGE FILE FORMATS	53
A8 CUSTOMER SERVICE	55
A8.1 SERVICE	55
A8.2 MAINTENANCE	55
A8.3 RECYCLING	55
A8.4 TROUBLE SHOOTING	56
A9 INDEX	57
ABOUT PCO	58

1. INTRODUCTION



Advantages of the pco.edge family

The pco.edge family is a breakthrough in scientific imaging cameras. It has the distinctive ability to simultaneously deliver extremely low noise, wide dynamic range, high quantum efficiency, high resolution and a large field of view - all in one image and at high frame rates.

Main Features (model-specific)

- ultra low readout noise: down to $0.8 e^-$ med
- high resolution: up to 5.5 Megapixel
- best dynamic range: up to 40000:1
- high-speed frame rates: up to 100 fps @ full resolution
- high quantum efficiency: up to 80%
- flexibility: user selectable choice of shutter mode
- free of drift: stabilized Peltier cooling in order to avoid any drift phenomena in image sequences

1.1 INTENDED USE

This camera system is designed for use by technicians, engineers and scientists. It is a scientific measuring instrument, which provides images. The camera may only be used according to the instructions of this manual. Provisions, limitations and operating conditions stated in this manual must be respected. Unauthorized modifications and alterations of the device are forbidden for safety reasons.

Areas of Application

- live cell microscopy
- single molecule detection
- localization microscopy
- lightsheet microscopy
- selective plane illumination microscopy
- SPIM
- structured illumination microscopy
- SIM
- TIRF microscopy / waveguides
- spinning disk confocal microscopy
- genome sequencing (2nd and 3rd gen)
- FRET
- FRAP
- lucky imaging astronomy
- adaptive optics
- solar astronomy
- fluorescence spectroscopy
- bio- & chemiluminescence
- high content screening
- photovoltaic inspection
- x-ray tomography
- ophthalmology
- flow cytometry
- biochip reading
- machine vision
- spectral (hyperspectral) imaging
- laser induced breakdown-spectroscopy (LIBS)

1.2 DATA OVERVIEW

This table shows an overview over all available pco.edge series camera models.

Type	Shutter	Readout Frequency	Line time ¹ (µs)	FPS ²	Exposure times	Sensor	Cooling
pco.edge 3.1 USB 3.0	rolling	105 MHz	24.99	50	500 µs ... 2 s	mono & color	+ 5°C air
	global	204 MHz	12.86	50	20 µs ... 100 ms		
	global reset	105 MHz	24.99	50	30 µs – 2 s		
pco.edge 4.2 LT USB 3.0	rolling	110 MHz	24.06	40	100 µs ... 10 s	mono	+ 10° C air
	global reset	110 MHz	24.06	40	30 µs ... 2 s		
pco.edge 4.2 USB 3.0	rolling	110 MHz	24.06	40	100 µs ... 20 s	mono	0°C air 0°C water
	global reset	110 MHz	24.06	40	30 µs ... 2 s		
pco.edge 4.2 Camera Link	rolling	95.3 MHz (slow scan)	27.77	35	100 µs ... 10 s	mono	+ 5°C air + 5°C water
		272.3 MHz (fast scan)	9.76	100			
pco.edge 4.2 Camera Link HS	rolling	100 MHz	26.58	36	100 µs ... 10 s	mono	+ 7°C air
		274 MHz	9.68	101			
pco.edge 5.5 USB 3.0	rolling	86 MHz	30.51	30	500 µs ... 2 s	mono & color	+ 5°C air + 5°C water
	global	160 MHz	16.40	28	20 µs ... 100 ms		
	global reset	86 MHz	30.51	30	30 µs ... 2 s		
pco.edge 5.5 Camera Link	rolling	95.3 MHz (slow scan)	27.52	33	500 µs ... 2 s	mono & color	+ 5°C air + 5°C water
		286 MHz (fast scan)	9.17	100			
	global	286 MHz	9.17	50	10 µs ... 100 ms		
	global reset	95.3 MHz (slow scan)	27.52	33	10 µs ... 2 s		
286 MHz (fast scan)		9.17	100				
pco.edge 5.5 Camera Link HS	rolling	100 MHz (slow scan)	26.24	35	500 µs ... 2 s	mono & color	+ 7°C air
		286 MHz (fast scan)	9.17	100			
	global	286 MHz	9.17	50	10 µs ... 100 ms		
	global reset	100 MHz (slow scan)	26.24	34	10 µs ... 2 s		
286 MHz (fast scan)		9.17	95				

¹ line time: the time between the reset start of a row of pixels and the reset start of the next row of pixels

² maximum frames per second @ full resolution

2. SAFETY INSTRUCTIONS



CLASS 1 LASER PRODUCT (only pco.edge CLHS)

Risk of injury due to dazzle.

- Do not point the laser beam at persons.
- Do not look into the laser beam or at direct reflexes.
- Manipulations of the laser device are not allowed.



DANGER

DAMAGED POWER CABLE OR POWER PLUG

Danger to life due to electric shock.

- Each time the camera is used, check the power cable for damage.



WARNING

ELECTRIC SHOCK WARNING DUE TO VOLTAGE PARTS INSIDE

Risk of injury due to electric shock.

- Never slide any items through slits or holes into the camera.



CAUTION

MOISTURE

Risk of injury due to electric shock if moisture enters the camera.

- To avoid the risk of water condensation, protect the camera against extreme changes of ambient temperature.



CAUTION

TRIPPING HAZARD

Risk of injury from tripping over loose cables.

- Never position the cable in a way that it could become a tripping hazard.

NOTICE

HUMIDITY, DUST OR RADIATION

Humidity, dust or X-rays could damage the camera.

- Never operate the camera in humid or dusty environments or in places with high levels of X-ray radiation.

NOTICE

SHOCK & VIBRATION

To avoid damaging the camera it must be firmly mounted and protected against strong shocks or vibrations.

- Use the camera's mounting threads to secure it.

NOTICE

LENS MOUNTING

Do not force the lens onto the camera.

- Screw in the lens gently to avoid thread damage.

NOTICE

LIQUIDS DAMAGE CAMERA

If liquids have penetrated the device.

- Switch the camera off immediately, detach it from power and contact PCO's customer support.

NOTICE

DAMAGED CAMERA HOUSING

If the camera has been dropped or the camera's housing is damaged.

- Switch the camera off immediately, detach it from power and contact PCO's customer support.

3. SYSTEM COMPONENTS

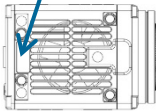
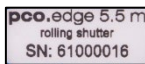

The camera system includes the following parts.

Camera

- F-mount optical connection (standard) for standard F-mount lenses and adapters
- C-mount ring provided for standard C-mount and microscopy connectors

Rear Panel

- Varies depending on model and interface
- DC Power Jack connects to power supply
- Input / Output 4x SMA connectors
- LED indicates camera status

Serial Number Tag

Mounting Thread

4x 1/4"- 20 UNC mounting threads

Frame Grabber Card/USB 3.0 Interface Card/USB 3.1 Gen2 Interface Card

- PCI Express card (Camera Link)
- PCI Express card (Camera Link HS)
- PCI Express card (2 x USB 3.0)
- PCI Express x4 / USB Type C + Type A (USB 3.1 Gen2) for pco.edge 4.2

Power Supply & Power Cord

- Output: 24 VDC / 36W / 1.5A
- Connector: Lemo FGG.0B
- Voltage input: 115 VAC - 230 VAC; IEC 60320 C14 plug
- Power cord IEC 60320 C13

Cable

Type depends on interface

Digital Camera Tools (USB flash drive content)

- pco.camware: software for camera control & image acquisition
- Camera driver & tools
- Software development kit (SDK) & demo programs in C / C++

4. INSTALLATION

All necessary files are on the accompanying USB flash drive. You may also download the latest versions of our software, camera driver and third party software drivers from the PCO website.

Minimum System Requirements

- Intel® Core™ i7
- RAM > 8 GB DDR3
- Windows 7 or higher
- Full-HD resolution display
- PCI Express x4 Gen 2 (CLHS)
- PCI Express x4 Gen 1 (CL)

Contact PCO for an appropriate system configuration.

4.1 DRIVER

There are three different kinds of interfaces available:

Camera Link (Frame Grabber card)

When operating the camera with Camera Link interface: run the appropriate grabber driver installation with default settings. For detailed installation instructions see **A4.2**.

Camera Link HS (Frame Grabber card)

When operating the camera with Camera Link HS interface: run the appropriate grabber driver installation with default settings. For detailed installation instructions see **A4.3**.

USB 3.0

When USB 3.0 is used as a camera interface, we suggest using the enclosed PCIe Interface card. For detailed installation instructions or further hardware recommendations, see **A4.4**.

NVIDIA Cuda Driver

Only relevant if an NVIDIA graphics card is used! **GPU Processing** is only working with NVIDIA graphics cards.

Update your NVIDIA driver for pco.camware. In case of an old driver version **GPU Processing** is not working. Therefore image processing is slow.

Check if **GPU Processing** is activated by having a look into the **Proc config** settings **4** in the **Convert Control** window **3** (see pco.camware manual).

If **GPU Processing** is disabled and greyed out, update your NVIDIA driver.

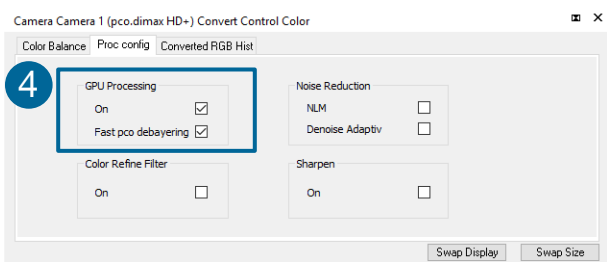
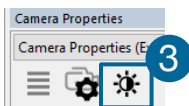

4.2 CAMWARE SOFTWARE

The pco.camware application software enables you to control every camera parameter or setting. Images can be displayed on a monitor and may be downloaded and stored. The USB flash drive contains the installation files for the software for latest Windows operating systems in 32 & 64 bit.

After a successful installation, you will find the program folder Digital Camera Toolbox in your program directory and a pco.camware 32 / 64 button on your desktop.

To uninstall the pco.camware program, use the Software feature under Windows' System Control.

Follow the Installation Wizard

- 1 **Install as admin** to install to program folder, otherwise it will be installed only to user folder
- 2 Then choose install directory
- 3 Choose components: select additional drivers for Camera Link interface Silicon Software DLL MeIV and for Camera Link HS DLL (CLHS) (no additional files needed for USB version)
- 4 After the next two screens installation is complete

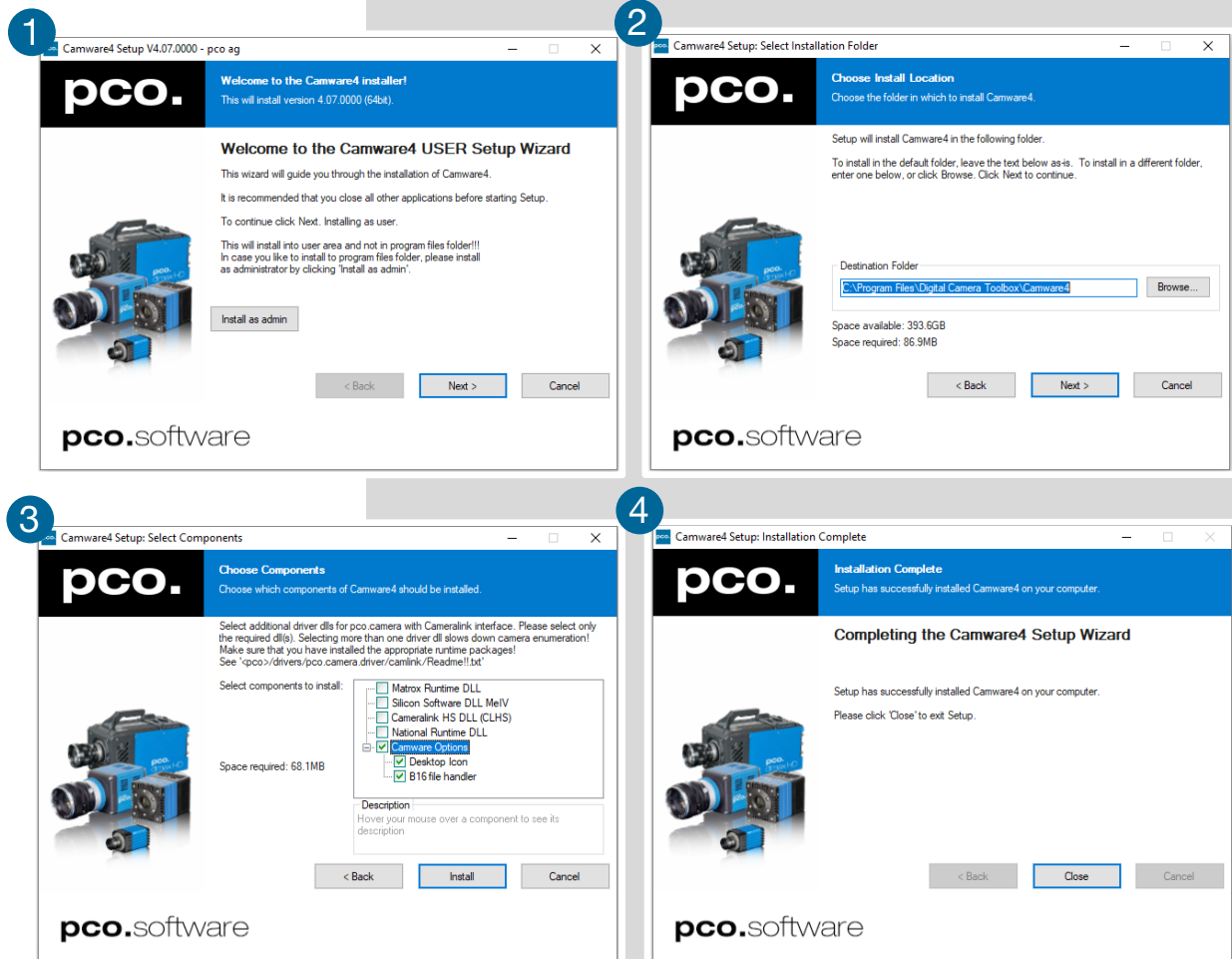

5. QUICK START

In order to get familiar with your new camera and software it might be helpful, first to aim the camera at an object easy to focus and visible at normal light conditions.

5.1 PREPARATION

- Computer is turned on
- Installation is finished (see chapter 4)
- An appropriate lens is attached (remove cap) or the camera is attached properly to the microscope, spectrograph or other scientific device
- Camera is connected to the computer
- Camera is connected to the power supply and ready (green LED flashes)

5.2 START



Start pco.camware and the graphical user interface starts up:

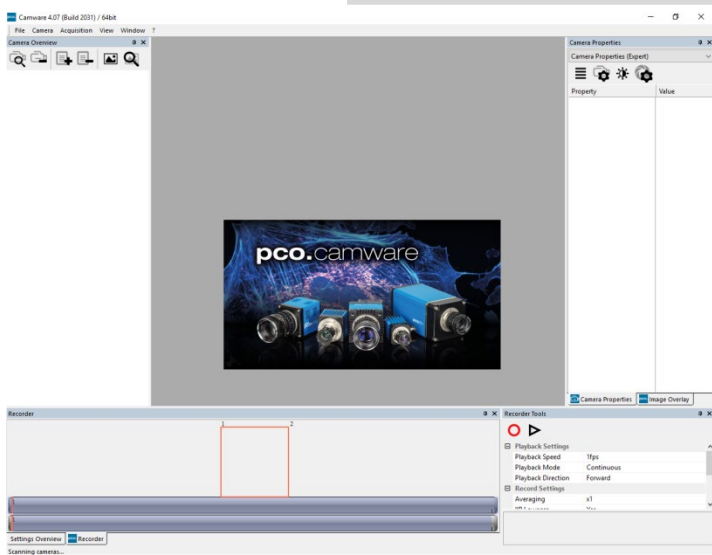

NOTE

Always install latest Camware version to use the full capabilities of your pco camera (www.pco.de/support).

5.3 FIRST IMAGE

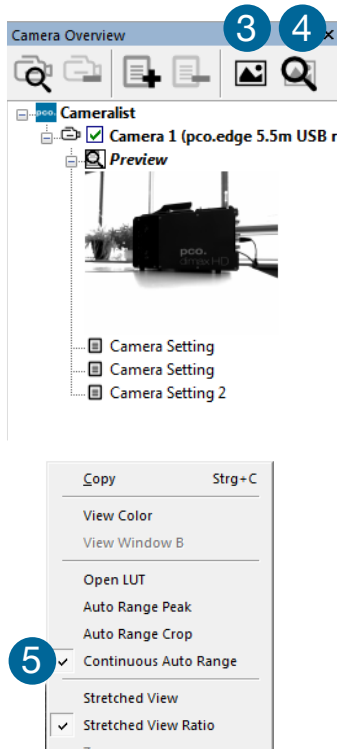

Follow the Instructions



- pco.camware must be started **1**
- A **View Window** **2** is shown automatically or open a new one **3**
- Start **Live Preview** **4**
- Right-click in the **View Window** & apply **Continuous Auto Range** **5**
- You may have to adjust **Exposure** time **6**, aperture and focus of the mounted lens
- Now you should clearly see the object in the window **7**

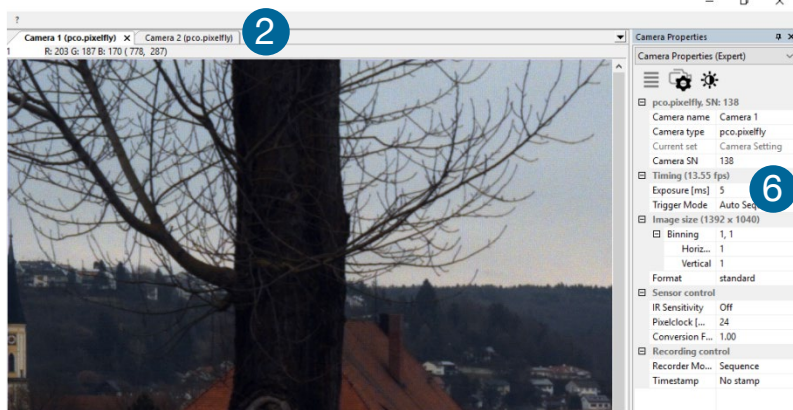

To change **Exposure** time (e.g. the image is still either too dark or too bright) and to record and save images, see pco.camware manual for detailed information.

NOTE

Live preview: useful for fast and easy camera adjustment and focusing.

6. SHUTTER MODES

6.1 ROLLING SHUTTER

NOTE:

For available Rolling Shutter readout modes see chapter 7.2.

NOTE

The exposure and delay time can be adjusted in steps of one line time (see 1.2).

In rolling shutter mode the pixel reset and exposure start is carried out line by line. Each line has the same exposure time, but a different start and end of exposure. The pco.edge image sensor consists of two discrete halves, which are exposed and read out simultaneously, i.e. from the outside to the center by default. Within one line, the exposure starts simultaneously for all pixels.

The exposure time of each row starts with reset of the corresponding row. Then after a predefined time, the exposure is stopped. The light induced accumulated charge carriers of the pixels in a line are shifted into memory in a low noise (readout) mode. This results in the total image appearing in memory corresponding to the line readout. The diagram shows different signal timing settings (see 7.1).

General Timing Diagram

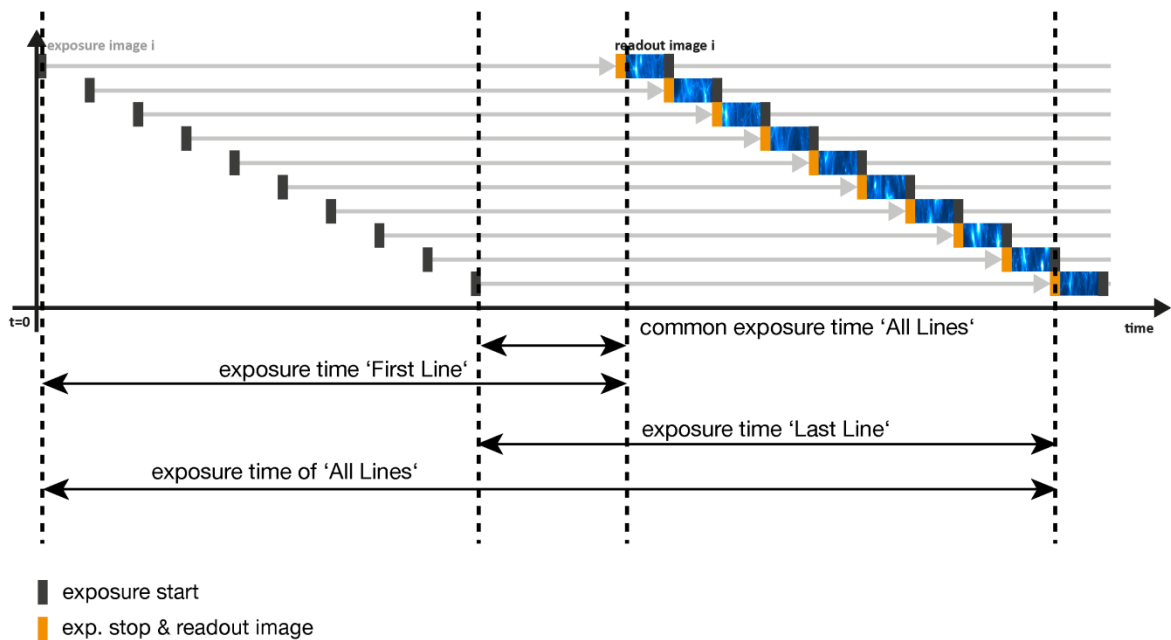

Camera Properties

Camera Properties (Expert)

- pco.edge 5.5 rolling shutter, SN: 73
 - Camera name: Camera 1
 - Camera type: pco.edge 5.5 roll...
 - Current set: Camera Setting
 - Camera SN: 73
- Timing (100.92 fps)
 - Exposure [us]: 500
 - Delay [ms]: 0

Camera (Rolling Shutter)	Exposure time	Delay time
pco.edge 3.1 USB 3.0	500 μs ... 2 s	0 ... 1 s
pco.edge 4.2 LT USB 3.0	100 μs ... 10 s	
pco.edge 4.2 USB 3.0	100 μs ... 20 s	
pco.edge 4.2 Camera Link	100 μs ... 10 s	
pco.edge 4.2 Camera Link HS	100 μs ... 10 s	
pco.edge 5.5 USB 3.0	500 μs ... 2 s	
pco.edge 5.5 Camera Link	500 μs ... 2 s	
pco.edge 5.5 Camera Link HS	500 μs ... 2 s	

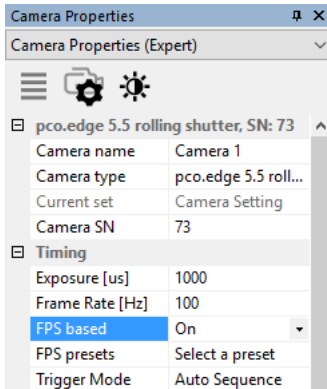

FPS based (only Camera Link interface)

The camera optimizes the image recording to achieve as close as possible the selected frame rate with chosen exposure time.

Only for **Auto Sequence** trigger mode and only available with Camera Link Interface

Set the frame rate first. If the time required for the image readout is longer than $1 / \text{frame rate}$, the frame rate will be reduced to $1 / t_{\text{readout}}$.

The frame rate can be adjusted in steps of 1 mHz (Rolling Shutter). If the selected exposure time requires a lower frame rate, the exposure time is cut to the maximum possible time at that frame rate.

Camera	Frame rate (FPS Based)	Exposure time
pco.edge 4.2 Camera Link	0.1...35 fps @ 95.3 MHz	100 μ s...10 s
	0.1...100 fps @ 272.3 MHz	
pco.edge 5.5 Camera Link	0.1...100 fps @ 272.3 MHz	500 μ s...2 s
	0.5...100 fps @ 286 MHz	

NOTE
 $\Delta t = t : 1 \text{ line time}$
 (see chapter 1.2)

Exposure time > Sensor frame readout time

In case the required exposure time is longer than the frame readout time, the image sensor is completely exposed to light for some time (Common time 'All Lines' also see General Timing Diagram). In case of a triggered flash illumination, this would be the best moment to illuminate the image sensor. The hardware signal for the common time is available on SMA input connector #4 (see 7.1).

This is an example timing diagram for **Trigger Mode Auto Sequence**

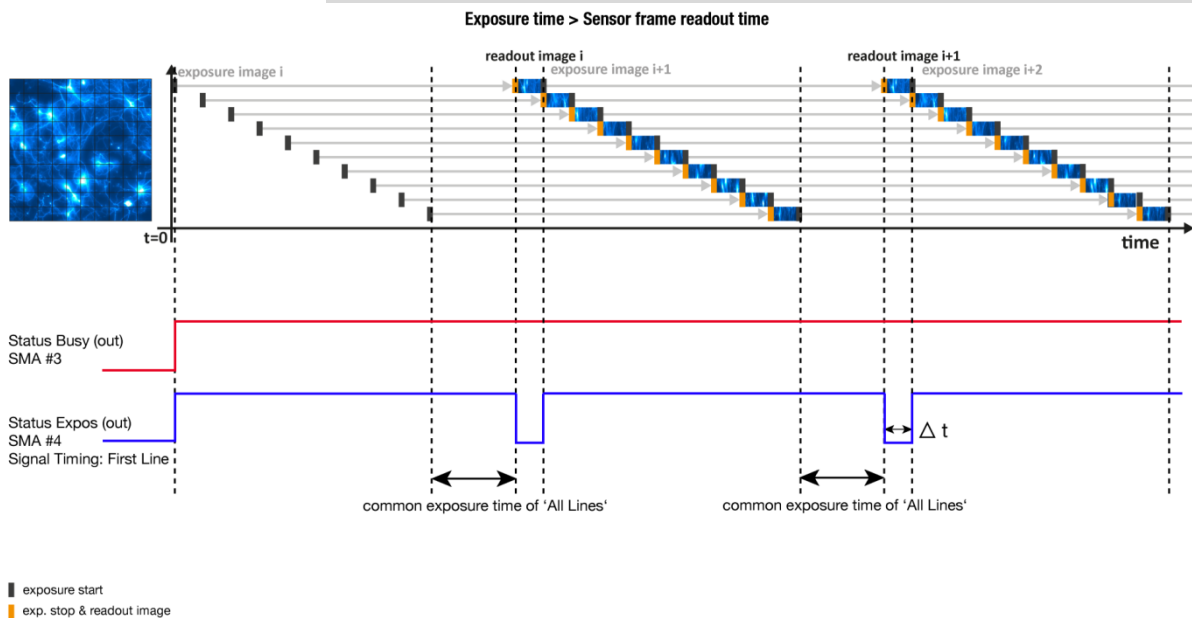

Exposure time < Sensor frame readout time

In case the required exposure time is shorter than the frame readout time, the image is composed of two exposure bands moving from the outside to the center of the sensor.

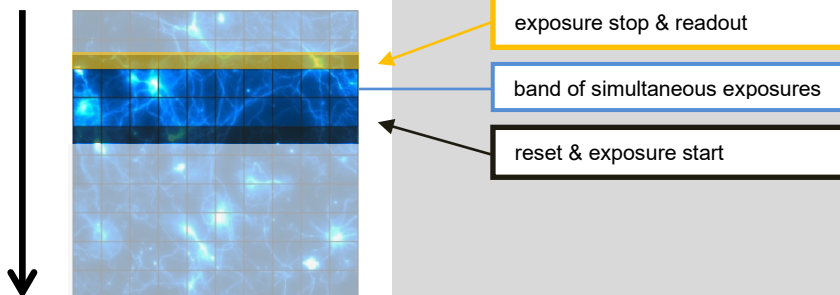

For example:

How can you calculate the band of simultaneous exposure lines at an exposure time of 100µs (@ full resolution) for pco.edge 4.2?

$$\frac{\text{Exposure time}}{\text{Line time}} = \text{Number of simultaneous exposure lines}$$

$$\frac{100 \mu\text{s}}{24.93 \mu\text{s}} = 4 \rightarrow 8 \text{ lines}$$

The lines are doubled because the sensor has two sensor halves.

This is an example timing diagram for **Trigger Mode Auto Sequence**, SMA output connector explanation see 7.1

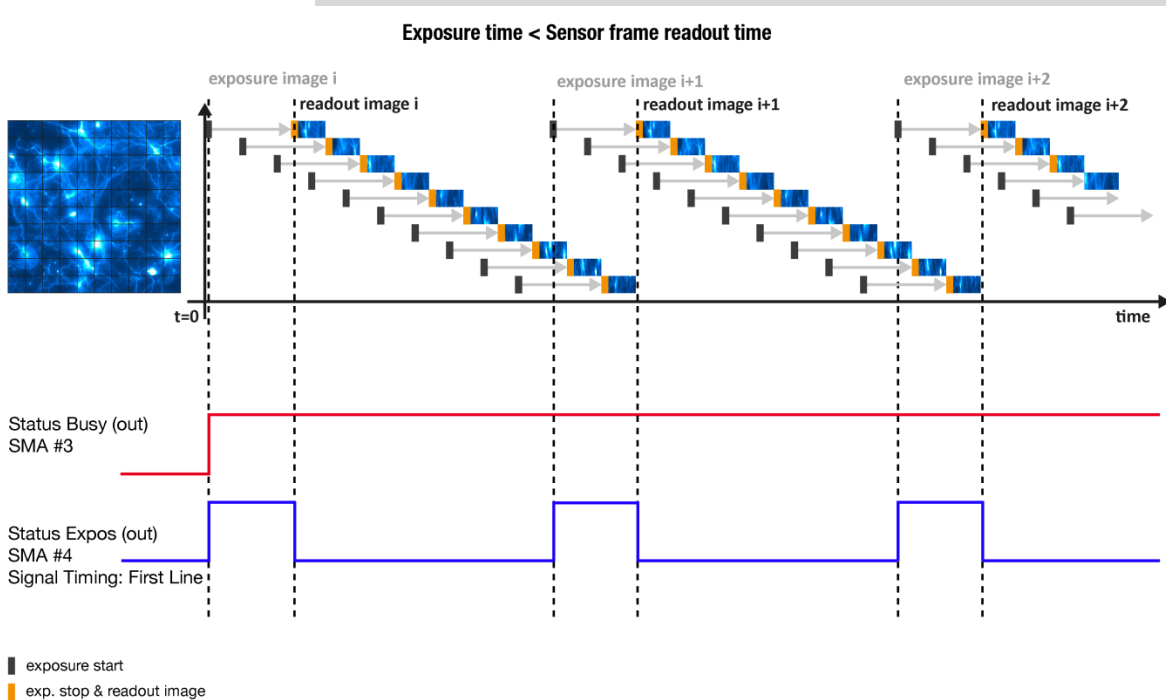

Details for External Exposure Start and External Exposure Ctrl

The detailed timing for external trigger includes system delay times, an adjustable additional delay time, and the jitter. Explanation for all **Trigger Modes** see pco.camware manual.

NOTE
The jitter t_{jit} can be a maximum of one row/line time.

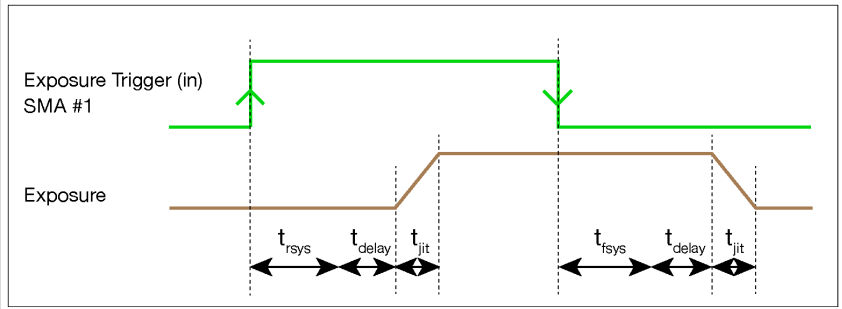

Name	Explanation	Value
t_{jit}	jitter	≤ 1 line time ¹
t_{rsys}	fixed system delay of rising edge	50 ... 150 ns
t_{fsys}	fixed system delay of falling edge	50 ... 150 ns
t_{delay}	delay time (set via pco.camware)	0 μ s ... 1 s

¹line time → see 1.2

For optimized synchronization (minimized jitter time) use the falling edge of the line signal at the status output (see 7.1).

System times t_{rsys} and t_{fsys} are depending on your camera settings and can be read out from your camera. For further information see pco.sdk manual function PCO_GetImageTiming.

6.2 GLOBAL SHUTTER

NOTE

Not available for pco.edge 4.2

First, all pixels are globally reset and these reset values are shifted into so-called diffusion nodes. From there, they are non-destructively read out into memory as reset dark images. The exposure starts after transfer of the reset dark image to the diffusion nodes, where they are stored on the chip. The exposure is stopped by global charge transfer to the diffusion nodes. Then, the exposure image is read out to the memory, where the former reset dark image is subtracted to perform an external correlated double sampling, which reduces the noise. Since two images have to be read out to yield one valid image, the sCMOS image sensor's **Global Shutter** mode has only half of the frame rate of the **Rolling Shutter** mode.

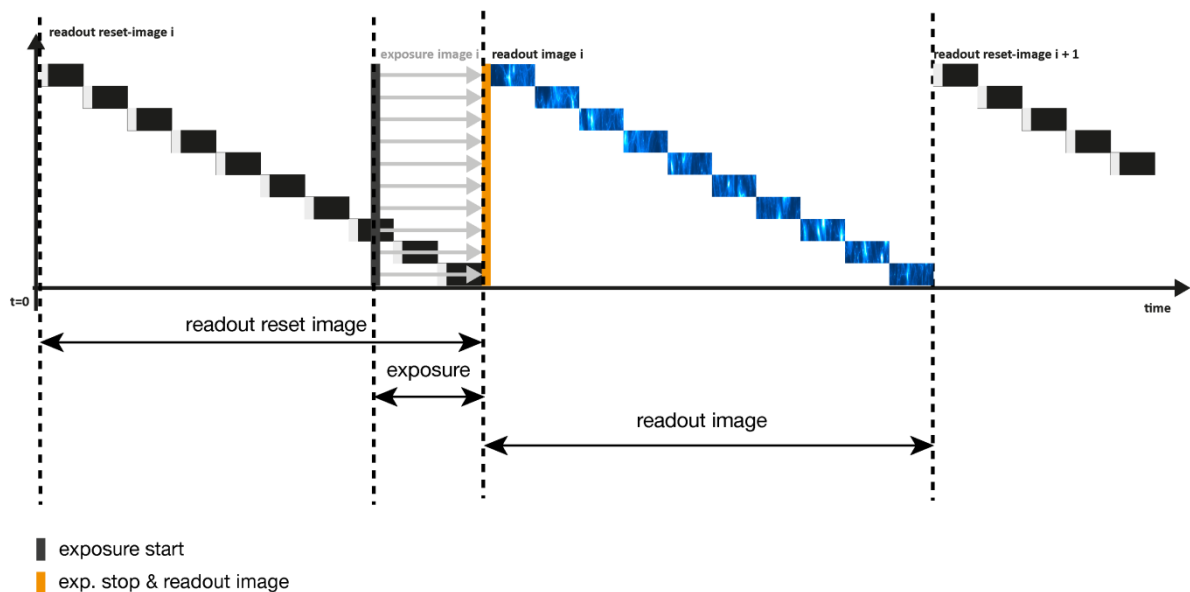

Timing

The exposure and delay time can be adjusted in steps of one line time (see 1.2).

Camera (Global Shutter)	Exposure time	Delay time
pco.edge 3.1 USB 3.0	20 μ s ... 100 ms	0 μ s ... 1 s
pco.edge 5.5 USB 3.0	20 μ s ... 100 ms	
pco.edge 5.5 Camera Link	10 μ s ... 100 ms	
pco.edge 5.5 Camera Link HS	10 μ s ... 100 ms	

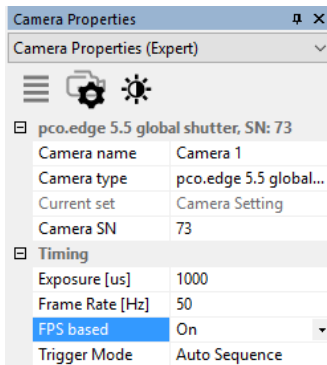

FPS based (only edge 5.5 Camera Link)

The camera optimizes the image recording to achieve as close as possible the frame rate with chosen exposure time.

Only for **Auto Sequence** trigger mode and only available with Camera Link Interface.

Set the frame rate first. If the time required for the image readout is longer than $1 / \text{frame rate}$, then the frame rate will be reduced to $1 / t_{\text{readout}}$. Minimum frame rate is $1 / \text{max. exposure time}$.

The frame rate can be adjusted in steps of 1 mHz (Global Shutter). If the selected exposure time would require a lower frame rate, the exposure time is cut to the maximum possible time at that frame rate.

Camera	Frame rate (FPS Based)	Exposure time
pco.edge 5.5 Camera Link	10 ... 50 fps @ 286 MHz	10 μ s ... 100 ms

External Exposure Start

(Auto Sequence respectively)

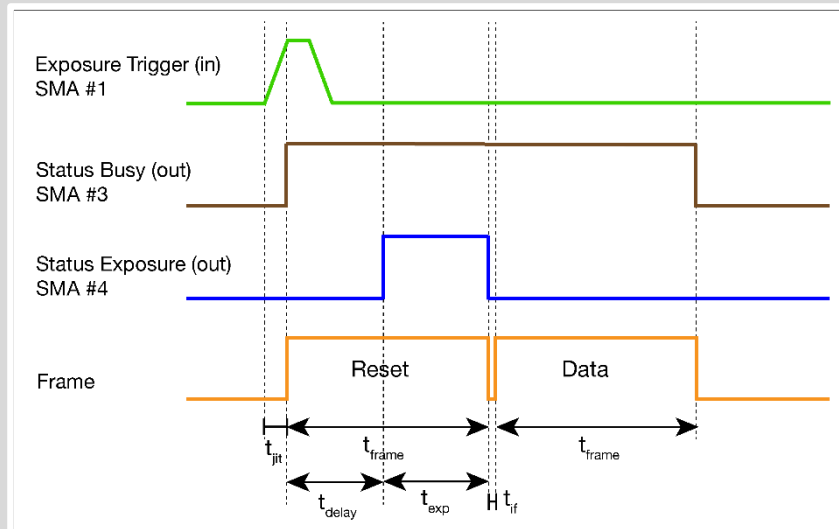

NOTE

If $t_{\text{exp}} < t_{\text{frame}}$ system delay (t_{delay}) is added before exposure starts.

Name	# of lines
t_{jit}	line time ¹
t_{frame}	$\frac{\text{ROI}(y) * \text{line time}}{2}$
t_{exp}	Programmable: 1 line time ¹ ... 100 ms
$t_{\text{delay}} \text{ (system)}$	$(t_{\text{frame}} - t_{\text{exp}})$
t_{if}	line time ¹

¹line time → see 1.2

The listed parameters can be read out via SDK function PCO_GetImageTiming dependent on the selected ROI. See pco.sdk manual.

External Exposure Control

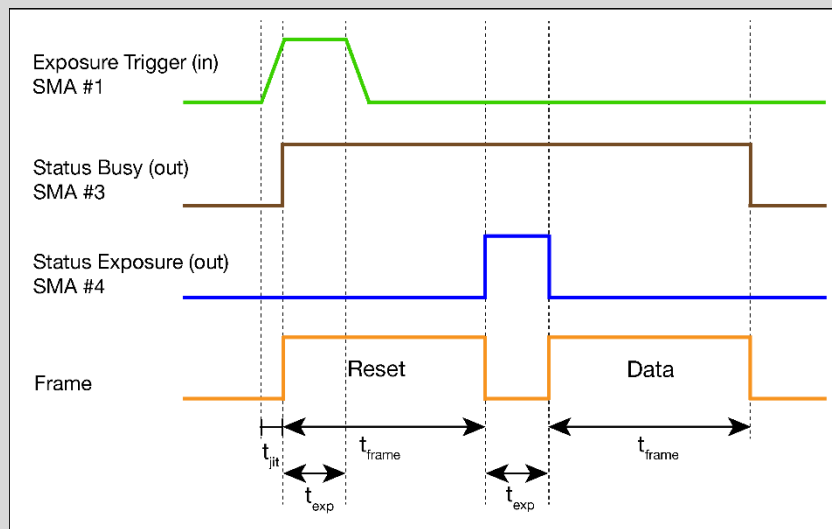

Name	# of lines
t_{jit}	line time ¹
t_{frame}	$\frac{ROI(y) * line\ time}{2}$
t_{exp}	Counted line time ¹

¹line time → see 1.2

In **External Exposure Control** trigger mode the external signal controls start of image acquisition and duration of the exposure.

First, all pixels are globally reset and these reset values are shifted into so-called diffusion nodes. From there, they are non-destructively read out into memory as reset dark images.

In this mode, the exposure starts always after the readout of the dark image is completed. The length of the exposure is detected by the sensor from the trigger input. The exposure is stopped by global charge transfer to the diffusion nodes after the respective time.

Then, the exposure image is read out to the memory, where the former reset dark image is subtracted to perform an external correlated double sampling, which reduces the noise.

Since two images have to be read out to receive one resulting image and the exposure cannot start during readout time of the dark image, this specific **Global Shutter** mode provides less than half of the frame rate of the **Rolling Shutter** mode.

6.3 GLOBAL RESET

NOTE

Global Reset is **not** available for pco.edge 4.2 Camera Link (HS) interface.

All pixels are globally reset and the exposure starts for all rows at the same time. The exposure stops row by row; therefore the duration of the exposure is not the same for all pixels. The rolling readout improves the image quality, but due to the difference in exposure time, a flash illumination is recommended. The readout (exposure stop) is done from the outside to the center.

General Timing Diagram

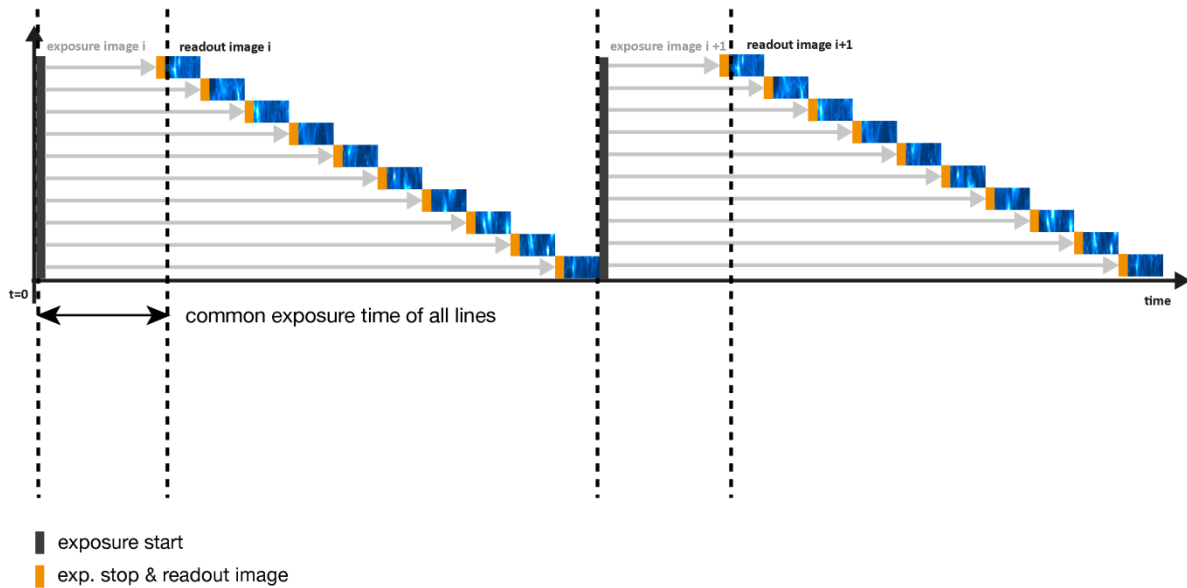

The exposure time of all rows starts simultaneously. The exposure time of the first row stops after the predefined time, the following rows are read out from the outside to the center row by row.

Note that this leads to a different duration of exposure time for each row. Therefore it is recommended to use a flash illumination at the beginning of the exposure start of all lines.

Timing

The exposure and delay time can be adjusted in steps of one line time (see 1.2).

Camera Properties	
Camera Properties (Expert)	
pco.edge 5.5 global reset, SN: 73	
Camera name	Camera 1
Camera type	pco.edge 5.5 glo...
Current set	Camera Setting
Camera SN	73
Timing (95.78 fps)	
Exposure [us]	500
Delay [ms]	0
FPS based	Off
Trigger Mode	Auto Sequence

Camera (Global Reset)	Exposure time	Delay time
pco.edge 3.1 USB 3.0	30 μ s – 2 s	0 μ s ... 1 s
pco.edge 4.2 LT USB 3.0		
pco.edge 4.2 USB 3.0		
pco.edge 5.5 USB 3.0		
pco.edge 5.5 Camera Link	10 μ s – 2 s	
pco.edge 5.5 Camera Link HS		

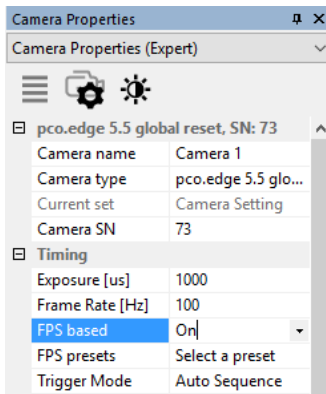

FPS based (only pco.edge 5.5 Camera Link)

The camera optimizes the image recording to achieve as close as possible the frame rate with chosen exposure time. Only for **Auto Sequence** trigger mode and only available with Camera Link Interface.

Set the frame rate first. If the time required for readout of the image is longer than $1 / \text{frame rate}$, then the frame rate will be reduced to $1 / t_{\text{readout}}$.

The frame rate can be adjusted in steps of 1 mHz (Global Reset).

If the selected exposure time would require a lower frame rate, the exposure time is cut to the maximum possible time at that frame rate.

Camera Global Reset	Frame rate (FPS Based)	Exposure time
pco.edge 5.5 Camera Link	1...33.3 fps @ 95.3 MHz	10 μ s...2 s
	1...100 fps @ 286 MHz	

Details for External Exp. Start and External Exp. Ctrl

The detailed timing for external trigger includes system delay times, an adjustable additional delay time and the jitter.

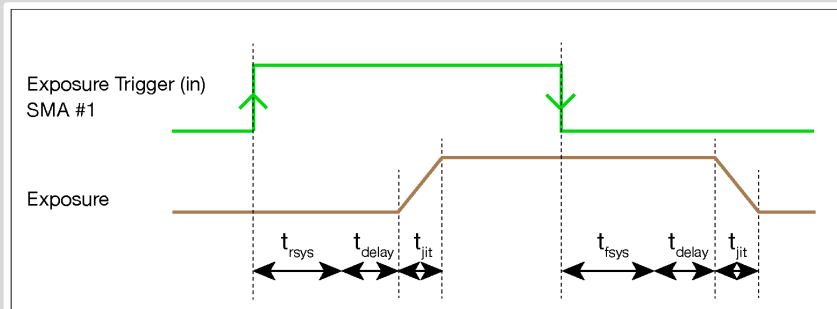

Name	Explanation	Value
t_{jit}	jitter	≤ 1 line time ¹
t_{rsys}	fixed system delay of rising edge	50 ... 150 ns
t_{fsys}	fixed system delay of falling edge	50 ... 150 ns
t_{delay}	programmable delay time	0 μ s ... 1 s

¹line time → see 1.2

For optimized synchronization (minimized jitter time) use the falling edge of the line signal at the status output (see 7.1).

System times are depending on your camera settings and can be read out from your camera. For further information see pco.sdk manual PCO_GetImageTiming.

7. CAMWARE 4 SOFTWARE

This chapter contains only camera-specific additions to the pco.camware manual. All main functions and explanations can be found in the pco.camware manual.

7.1 HARDWARE IO CONTROL

☐	Hardware IO Control	
☐	Exposure Trigger	
1	Exposure Trigger	On
	Signal Polarity	Rising
2	Acquire Enable	
	Acquire Enable	On
	Signal Polarity	High
3	Status Busy	
	Status Busy	On
	Signal Polarity	High
4	Status Expos	
	Select IO Signal	Status Expos
	Signal Timing	Show time of 'Last Line'
	Status Expos	On
	Signal Polarity	High

Change settings using the drop-down menu.

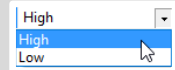

For electrical specification, see chapter **A1.3**

Exposure Trigger 1

If checked on, a signal for **External Exposure Start** or **External Exposure Control Trigger Mode** (see chapter 6.3.1) is accepted at the **Exposure Trigger** SMA input #1.

Exposure Trigger: On; Off
Signal Polarity: Rising; Falling

Acquire Enable 2

If checked on, a signal for Acquire Mode or Sequence Trigger Mode is accepted at the **Acquire Enable** SMA input #2.

Acquire Enable: On; Off
Signal Polarity: High; Low

Status Busy 3

If checked on, a signal indicating busy status is provided at the status busy output. Once an acceptable trigger edge is received, 'busy' goes to status high. As soon as 'busy' goes low again, a new trigger edge is accepted.

Status Busy: On; Off
Signal Polarity: High; Low

Status Expos 4

If checked on, a signal indicating exposure or line status is provided the status output. **Status Expos** indicates the actual exposure window for one frame. **Status Line:** use the falling line edge for optimized synchronization (minimized jitter; see page 16).

Select IO Signal: Status Expos; Status Line
Signal timing: Show time of 'First Line'; Show common time of 'All lines'; Show time of 'Last line'; Show overall time of 'All lines'
Status Expos: On; Off
Signal Polarity: High; Low

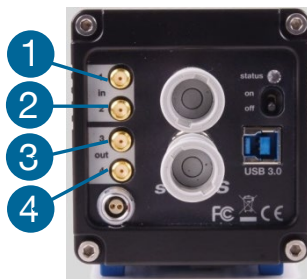

Enabling and Polarity of I/O Signals

The polarity of the I/O signals indicating their active states is selectable (positive or negative logic).

The polarity of level-sensitive signals can be set to **High** (positive logic) or **Low** (negative logic).

The polarity of edge-sensitive signals can be set to **Rising** (positive logic) or **Falling** (negative logic).

Detailed Explanation for Status Expos SMA #4 Signal Timing

Setting in pco.camware:

Status Expos	
Select IO Signal	Status Expos
Signal Timing	Show time of 'Last Line'
Status Expos	On
Signal Polarity	High

- 1 Show time of 'Last Line'
- 2 Show time of 'First Line'
- 3 Show common time of 'All Lines'
- 4 Show time of 'Last Line'
- 5 Show overall time of 'All Lines'

Rolling Shutter **Signal Timing** options are available (only if shutter mode is set to **Rolling Shutter**, see 7.2 Setup).

There are four signal types available:

- 1 Shows the exposure time of the first rolling shutter line ($t_{\text{firstline}}$)
- 2 Shows when all sensor lines are exposed (t_{global})
- 3 Shows the exposure time of the last rolling shutter line (t_{lastline})
- 4 Shows if any sensor line is integrating (t_{alllines})

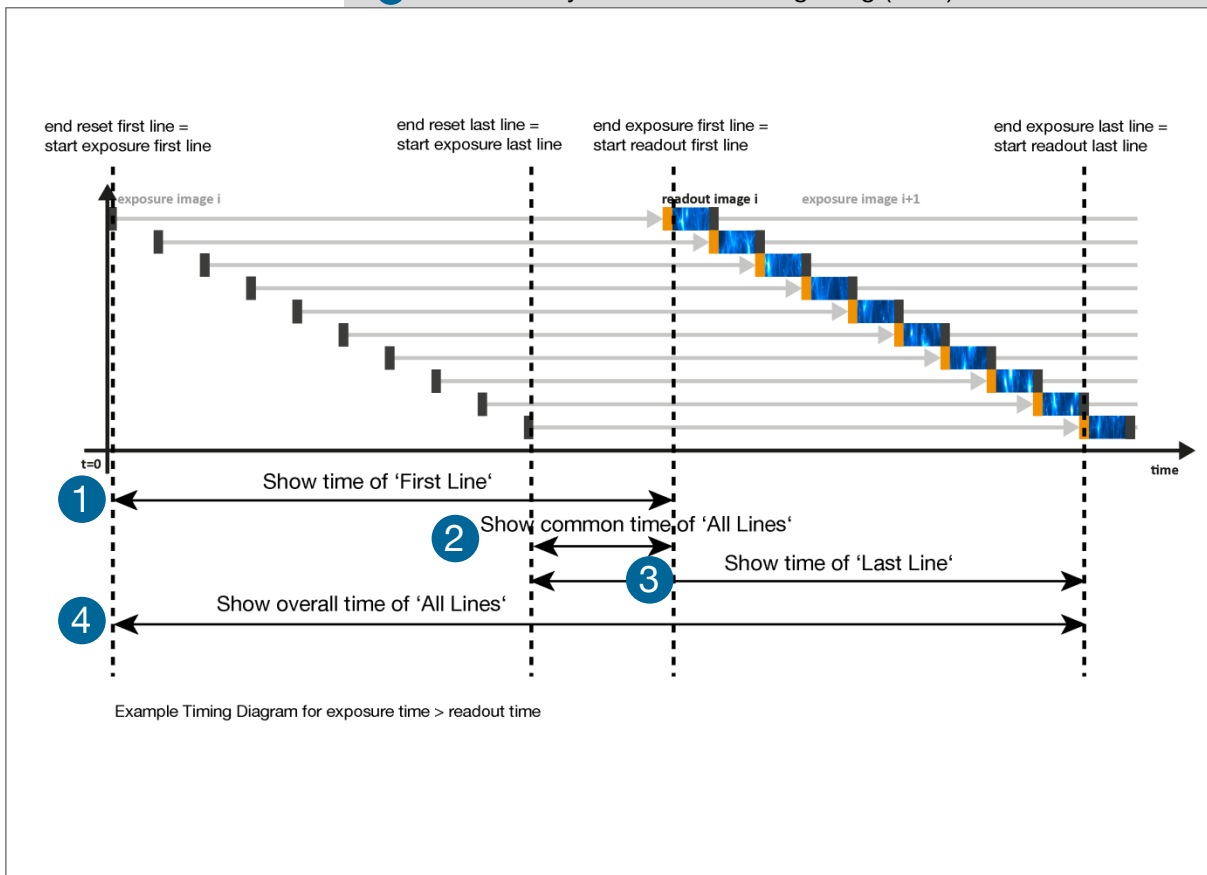

7.2 SHUTTER MODE SETUP

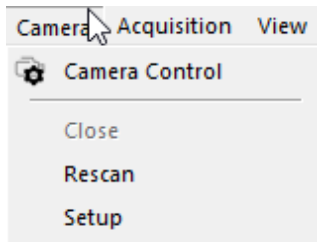

Open the pco.camware tab **Camera** and click **Setup** to open this menu.

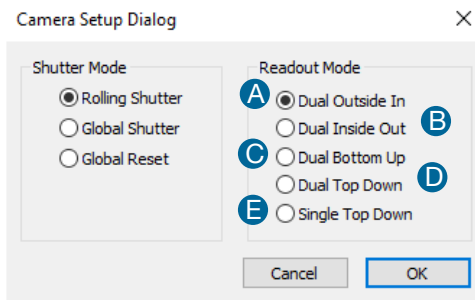

Setup

Switch between Rolling Shutter, Global Shutter and Global Reset Mode. The camera will automatically restart.

Five different readout modes are available in **Rolling Shutter** mode (6.1) (only B/W cameras). Standard mode is **Dual Outside In**. In **Single Top Down**, the pco.edge provides only half of the normal frame rate. Software rotates the image recorded by the sensor by 180°. This means, the last line of the image is the first line of the sensor.

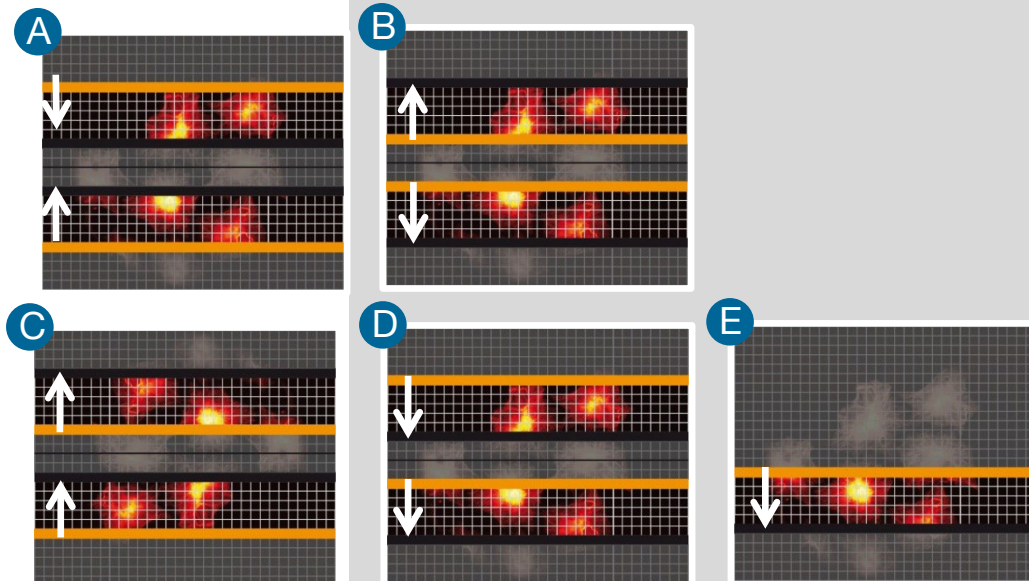

7.3 REGION OF INTEREST (ROI)

ROI (Region of Interest) selects a part of the sensor to be read out.

Vertical ROI: In order to speed up the frame rate and to reduce the amount of image data set the ROI symmetrical to the horizontal center line.

Horizontal ROI: In order to reduce the amount of image data set a horizontal ROI. A horizontal ROI will not change the frame rate.

For a detailed explanation see the pco.camware manual

ROI table

Camera	ROI horizontal steps	ROI vertical steps	Minimum ROI	Vert. symm. ROI
pco.edge 3.1 USB 3.0	4	1	64x16	no
pco.edge 4.2 LT USB 3.0	4	1	64x16	no
pco.edge 4.2 USB 3.0	4	1	64x16	no
pco.edge 4.2 Camera Link	20	2	40x16	yes
pco.edge 4.2 Camera Link HS	16	1	64x16	no
pco.edge 5.5 USB 3.0	4	1	64x16	no
pco.edge 5.5 Camera Link	160	2	160x16	yes
pco.edge 5.5 Camera Link HS	16	1	64x16	no

Software based ROI (Soft-ROI) (only Camera Link interface)

Calculates the Region of Interest via software. The resolution of pco.edge cameras with Camera Link interface can be adjusted in steps of 1 – 4 pixels.

Since the readout architecture of Camera Link cameras is not able to address single pixels, this downsizing is done by software.

If you work with pco.camware or Device Adapters (µManager, Labview...) or with pco.sdk, the Soft-ROI is disabled by default. For further information, see the SDK description.

ROI table with Soft-ROI Option enabled (only Camera Link interface)

pco.edge 4.2 Camera Link	1	1	40x16	no
pco.edge 5.5 Camera Link	4	1	160x16	no

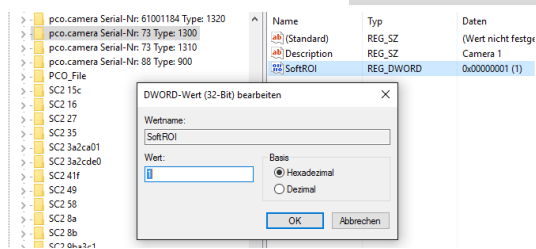

Open regedit to control Soft-ROI: under HKey-Current-User/Software/PCO/ create a DWORD value with the name SoftROI for each camera. Set this value to 1 to enable Soft-ROI. Remove or set this value to 0 to disable Soft-ROI by default. Keep in mind that unsymmetrical ROI decreases FPS. Above table shows values for Soft-ROI enabled.

APPENDIX

A1 TECHNICAL DATA	27
A1.1 DATA SHEET	27
A1.2 MECHANICAL DIMENSIONS	28
A1.2.1 CAMERA LINK VERSION	28
A1.2.2 USB VERSION	29
A1.2.3 CAMERA LINK HS VERSION	29
A1.2.4 WATER-COOLED STANDARD VERSION	30
A1.3 REAR PANEL	31
A2 HARDWARE MOUNTING	33
A2.1 CAMERA MOUNTING	33
A2.1.1 INSTABLE MOUNTING	33
A2.1.2 CORRECT MOUNTING	33
A2.1.3 COOLING	34
A2.2 PCO F-MOUNT ADAPTER	35
A2.3 CHANGE FROM F-MOUNT TO C-MOUNT	36
A3 WATER COOLING OPTION PCO.AQUAMATIC II	37
A3.1 SYSTEM COMPONENTS	37
A3.2 FIRST TIME INSTALLATION	38
A3.3 OPERATION	39
A3.4 DIMENSIONS	40
A3.5 YOUR OWN COOLING SYSTEM	40
A4 INTERFACES	41
A4.1 CABLING	41
A4.2 CAMERA LINK	42
A4.2.1 FRAME GRABBER INSTALLATION	42
A4.2.2 MICRO DIAGNOSTICS TOOL	43
A4.3 CAMERA LINK HS INTERFACE	44
A4.3.3 CABLING	44
A4.3.4 SYSTEM REQUIREMENTS	44
A4.3.5 SAFETY INSTRUCTIONS	44
A4.3.6 FRAME GRABBER INSTALLATION	45
A4.3.7 VISION POINT SOFTWARE	46
A4.3.8 UPDATE FIRMWARE OF THE GRABBER	47
A4.4 USB 3.0	48
A4.4.1 DRIVER INSTALLATION	48
A4.4.2 USB 3.0 CARD INSTALLATION	48
A4.4.3 RING BUFFER AND FIFO	50
A5 BINNING WITH CMOS SENSORS	51
A6 LIGHTSHEET SCANNING MODE	52
A7 IMAGE FILE FORMATS	53
A8 CUSTOMER SERVICE	55
A8.1 SERVICE	55
A8.2 MAINTENANCE	55
A8.3 RECYCLING	55
A8.4 TROUBLE SHOOTING	56
A9 INDEX	57
ABOUT PCO	58

A1 TECHNICAL DATA

A1.1 DATA SHEET

Image sensor		
Type of sensor	scientific CMOS (sCMOS)	
Image sensor	4.2	5.5
Resolution (h x v)	2048 x 2048 active pixels	2560 x 2160 active pixels
Pixel size (h x v)	6.5 µm x 6.5 µm	6.5 µm x 6.5 µm
Sensor format / diagonal	13.3 mm x 13.3 mm / 18.8 mm	16.6 mm x 14.0 mm / 21.8 mm
Shutter mode	Rolling Shutter (RS) Global Reset (GR)	Rolling Shutter (RS) Global Shutter (GS) Global Reset (GR)
Spectral range	370 nm ... 1100 nm	370 nm ... 1100 nm

Camera	
Dynamic range A/D	16 bit
Binning (h x v)	1x1 ... 4x4
Cooling method	peltier with forced air (fan) and water cooling (optional)
Trigger input signals	frame trigger, acquire (SMA connectors)
Trigger output signals	exposure, busy (SMA connectors)
Data interface	Camera Link , Camera Link HS, USB 3.0
Timestamp	in image (1 µs resolution)

General		
Power supply		12 .. 24 VDC (+/- 10 %)
Power consumption	CL ¹	20 W max. (typ. 10 W @ 20 °C)
	USB	21 W max. (typ. 11 W @ 20 °C)
	CLHS ³	32 W max. (typ. 20 W @ 20 °C)
Weight (with F-mount)	CL ¹	700 g
	CL WAT ²	1160 g
	USB	930 g
	CLHS ³	1010 g
Operating temperature range		+10 °C ... +40 °C
Operating humidity range		10 % ... 80 % (non-condensing)
Storage temperature range		- 10 °C ... +60 °C
Optical interface		F-mount & C-mount
CE / FCC certified		yes

¹Camera Link ²Camera Link water-cooled ³Camera Link HS

Camera	Sensor temperature
pco.edge 3.1 USB 3.0	5 °C
pco.edge 4.2 LT USB 3.0	10 °C
pco.edge 4.2 USB 3.0	0 °C
pco.edge 4.2 Camera Link	5 °C
pco.edge 4.2 / 5.5 Camera Link HS	7 °C
pco.edge 5.5 USB 3.0 / Camera Link	5 °C

A1.2 MECHANICAL DIMENSIONS

A1.2.1 CAMERA LINK VERSION

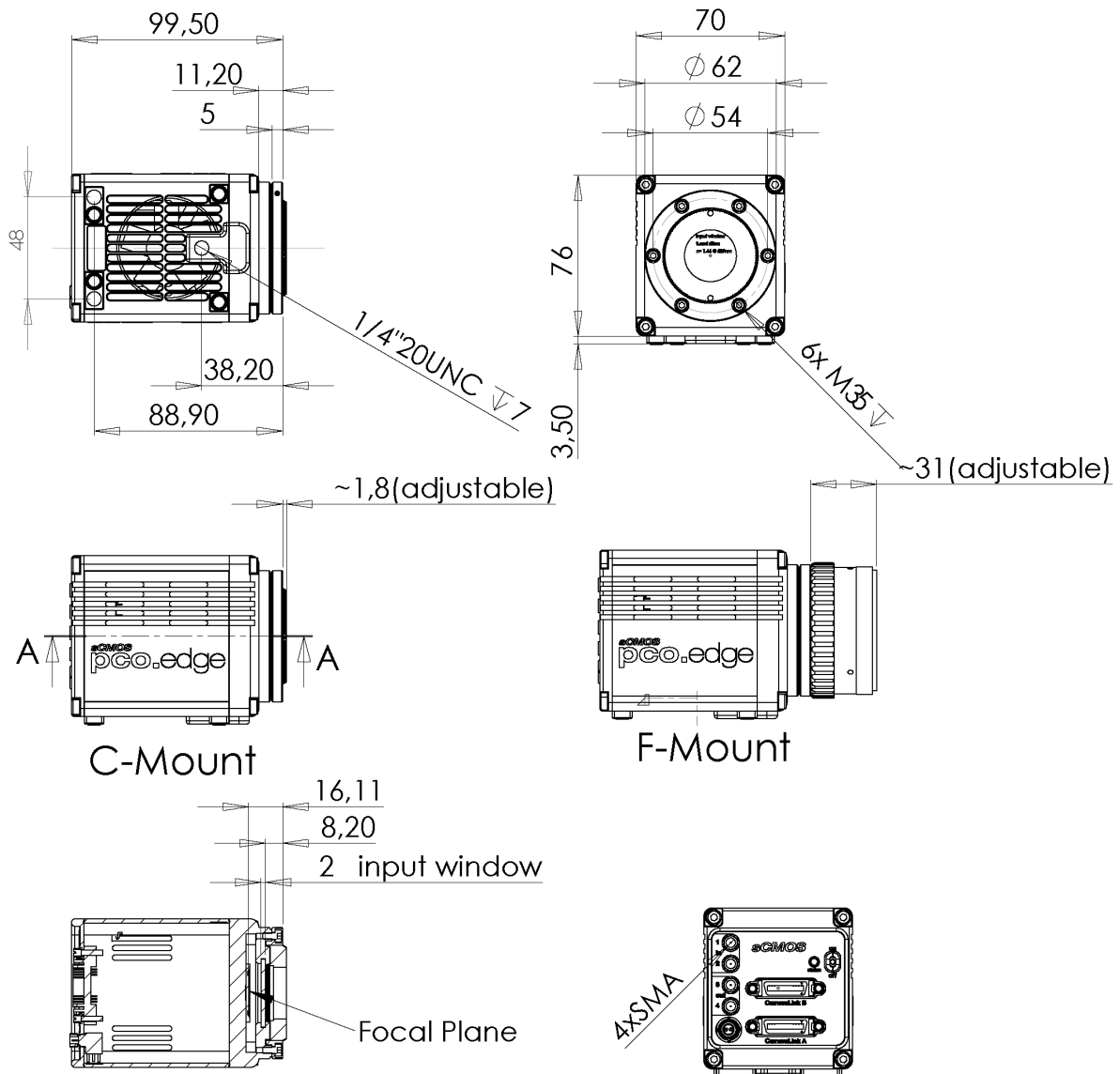

(pco.edge4.2 / 5.5: Camera Link)

A1.2.2 USB VERSION

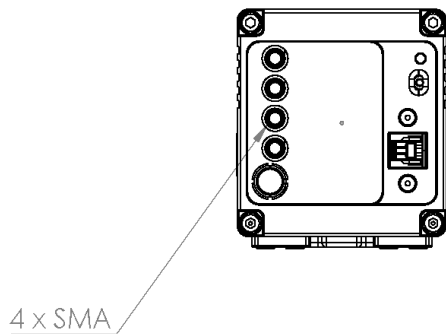

The USB version differs only on the back to the Camera Link version. (pco.edge 3.1 / pco.edge 4.2 LT)

A1.2.3 CAMERA LINK HS VERSION

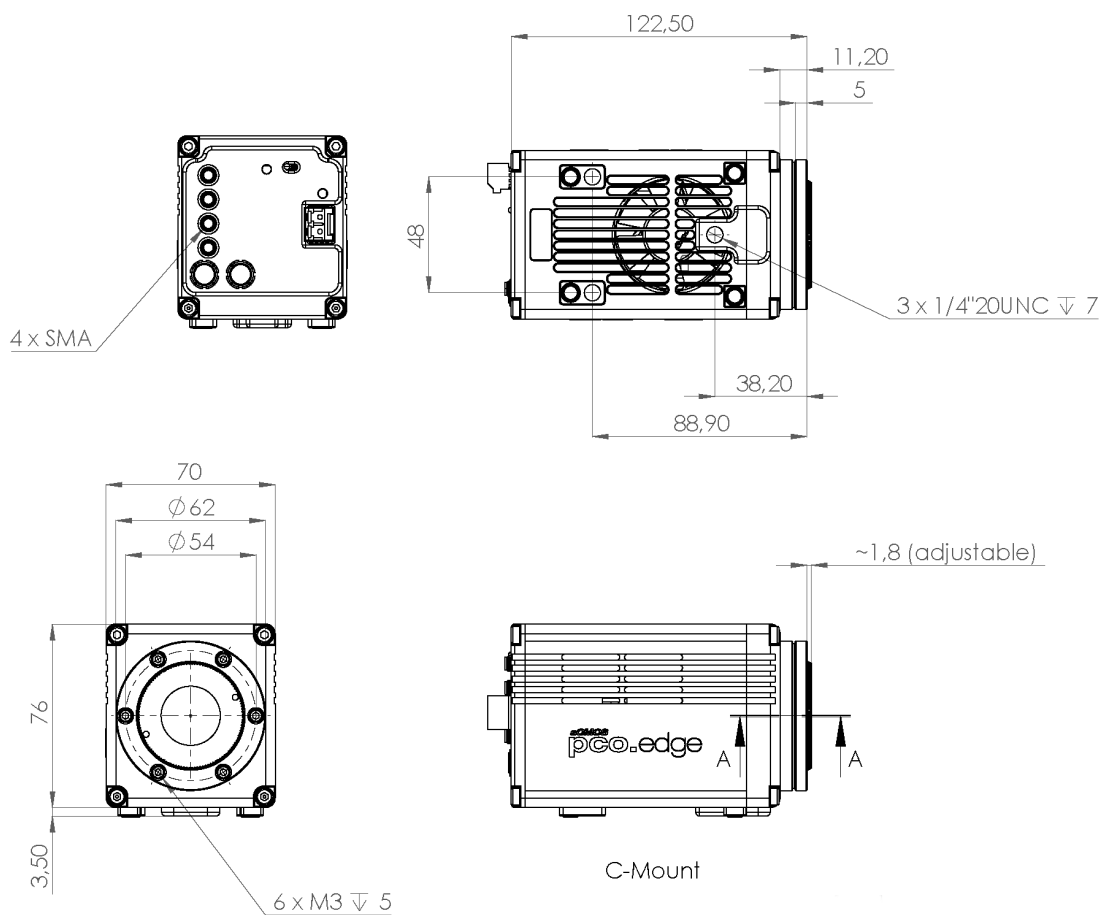

(pco.edge 4.2 / 5.5 Camera Link HS)

A1.2.4 WATER-COOLED STANDARD VERSION

Water cooled Camera Link Version (pco.edge 4.2 / 5.5 Camera Link)

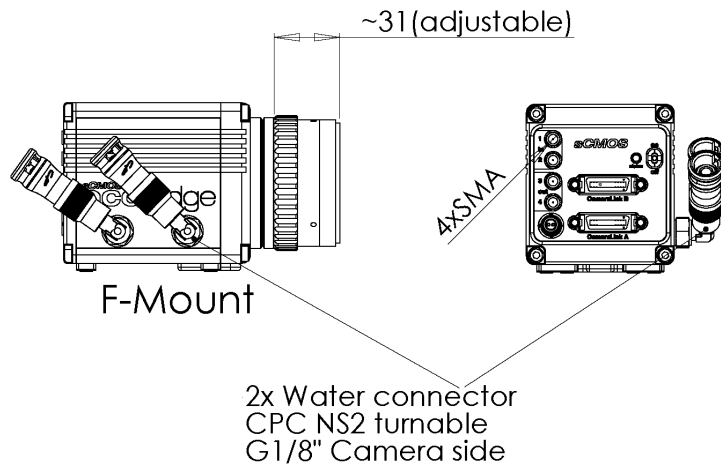

Water cooled USB Version (pco.edge 4.2 USB / 5.5 USB)

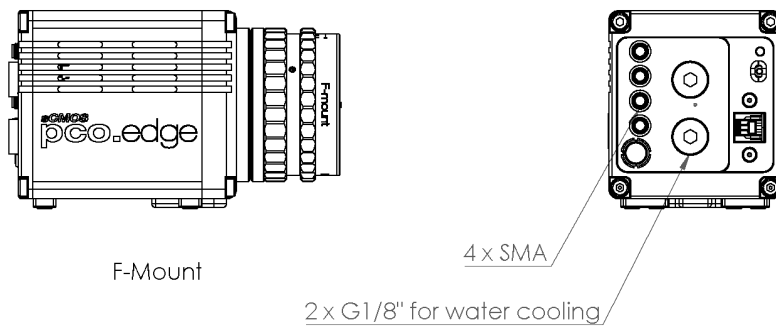

The housing size is similar to the dimensions of the standard version. The USB 3.0 interface version has the hose couplings on the camera's rear instead.

Water cooled Camera Link HS Version (pco.edge 4.2 / 5.5 CLHS)

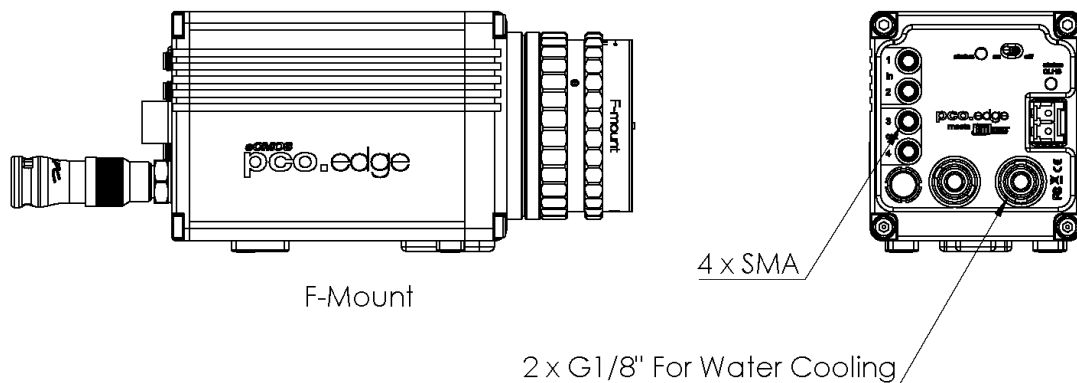

A1.3 REAR PANEL



Camera Links HS version



USB 3.0 version

SMA Inputs 1 (see chapter 7.1)**Input (1=Exposure Trigger; 2=Acquire Enable)**

type	digital
level	3.3 V LVTTTL (5 V tolerant)
coupling	DC
impedance	1 k Ω
slew rate	> 1 V/ms

SMA Outputs 2 (see chapter 7.1)**Output (3=Status Busy; 4=Status Expos)**

type	digital
level	3.3 V LVTTTL
coupling	DC
load current	max. 100 mA

Power Input 3**LEMO socket ECG.0B.302.CLV**

Pin1	VCC 24 V DC (+/- 10 %)
Pin2	ground

Appropriate Lemo plug: FGG.0B.302.CLAD52Z

**Power Output / Lens Control 4****LEMO socket EEG.0B.304.CLN**

Pin1	12 V output (15 W)
Pin2	RXD (bidirectional modulated communication for lens control)
Pin3	TXD (communication for lens control)
Pin4	ground

Appropriate Lemo plug: FGG.0B.304.CYCD52Z

Status LED 5

Color		Description
red blinking	●	error
green continuous	●	camera is booting
green blinking	●	camera is ready for operation
yellow blinking	●	recording on

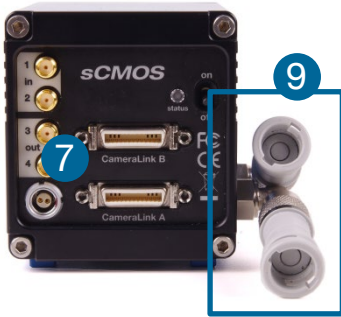

Camera Link version
with water-cooling

Power Switch ⑥

on / off

Interface Connector ⑦

Depending on interface: USB 3.0, Camera Link or Camera Link HS.

Interface Status LED (Camera Link HS) ⑧

Color		Description
off	○	no power and/or waiting for software
green continuous	●	link established; data transfer may take place
green blinking	●	hardware ok, but connection interrupted / not established

Water Connectors ⑨

Colder Product Company SM212 ¼ hose connector

A2 HARDWARE MOUNTING

A2.1 CAMERA MOUNTING

A2.1.1 INSTABLE MOUNTING



These instructions are not valid for every application. Especially in microscopy when extreme magnification is used, the slightest vibration can disturb images.

The pco.edge needs a stable mounting plate to avoid disturbing vibrations and to ensure a consistent high image quality. (pictures are mounting proposals).

Don't use such an instable mounting plate!

A2.1.2 CORRECT MOUNTING

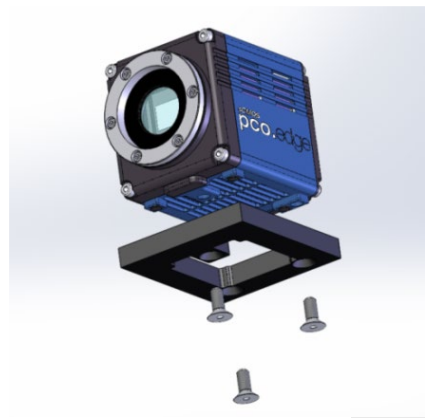

Recommended Mounting

The mounting plate must have a centred opening, as the cooling fan is located on the bottom of the pco.edge. The fan and its louvers must never be blocked.



A stable fixture for the rear area of the camera is of importance.

Attach your pco.edge camera with three ¼" - 20 UNC hexagon socket screws.



Caution

- Mount the pco.edge on a stable plate
- Use all three mounting threads
- Never block the fan and the louvers

A2.1.3 COOLING

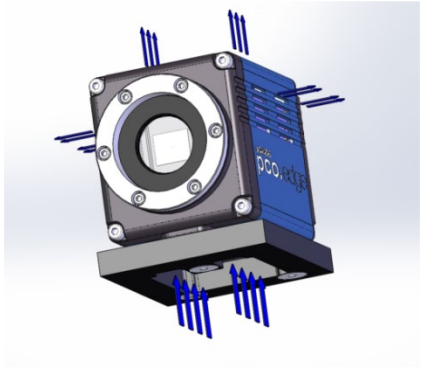

These images show the air flow of the pco.edge camera. The fan and the air intake are at the bottom of the camera. The air outlets are on top and on both sides of pco.edge. The camera needs a sufficient supply of fresh air to ensure a constant operating temperature.



Caution

- Never block the fan and the louvers
- Keep adequate distance to other components
- Provide a sufficient supply of fresh air
- Mounting plate needs a cut-out for cooling

A2.2 PCO F-MOUNT ADAPTER



PCO's proprietary F-mount adapter for lenses with automatic diaphragm. Sets manually the lens aperture by turning the ring on the adapter.

F-mount lenses without automatic diaphragm can be fastened to the camera's mount but the aperture not changed.



Adjust Back Focal Length

To adjust the back focal length (e.g. you cannot focus to infinity or to the minimum object distance of your lens), proceed as follows:

Set the focus of your lens to infinity. Look at an object in infinity and generate a sharp image by turning the adapter. Use the rearmost ring to fix the setting.

Matching Lenses with Automatic Diaphragm

Nikon: all Nikkor lenses of type D and type G (not for type E, this one is only electronic).

Zeiss: all ZEISS ZF.2 lenses (Otus, Milvus, Interlock, Distagon, Planar).

Sigma: only lenses, which already have a manual diaphragm ring; all other lenses have got an aperture control lever, but which does not spring back, if you turn the aperture ring at the adapter.

Tamron: only some lenses provide automatic diaphragm (no particular lens family):

Type 35mm F-Mount

- [A012](#) -> SP 15-30mm F/2.8 Di VC USD
- [A007](#) -> SP 24-70mm F/2.8 Di VC USD
- [A009](#) -> SP 70-200mm F/2.8 Di VC USD
- [A011](#) -> SP 150-600mm F/5-6.3 Di VC USD
- [F012](#) -> SP 35mm F/1.8 Di VC USD
- [F013](#) -> SP 45mm F/1.8 Di VC USD
- [F017](#) -> SP 90mm F/2.8 Di MACRO 1:1 VC USD

Type APS-C(H) F-Mount

- [B001](#) -> SP AF 10-24mm F/3.5-4.5 Di II LD Aspherical [IF]
- [B005](#) -> SP AF 17-50mm F/2.8 XR Di II VC LD Aspherical [IF]
- [G005](#) -> SP AF 60mm F/2.0 Di II LD [IF] Macro 1:1

A2.3 CHANGE FROM F-MOUNT TO C-MOUNT

How to change the optical input from F-mount to C-mount.

NOTICE

MECHANICAL DAMAGE OF THE C-MOUNT RING

Tightening the hexagon socket setscrews too tight will permanently damage the C-mount ring.

- Use a torque wrench and select a maximum torque of 1 Nm to tighten the hexagon socket setscrews.

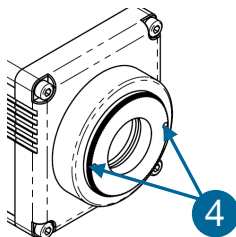
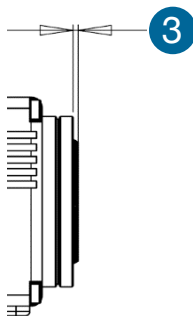
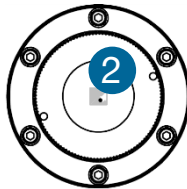
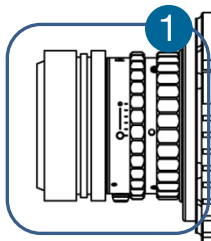

Step 1: Remove F-mount adapter

Turn the black lock ring ① counterclockwise to loosen the F-mount adapter and then unscrew it.

Step 2: Insert C-mount ring

Carefully screw the C-mount ring ② clockwise. The two hexagon setscrews must be visible on the outside.

Step 3: Adjust flange focal distance

In order to reach the standard support dimension of C-mount (17.526 mm), screw in the C-mount ring so far that it protrudes outwards a distance of 1.8 mm ③.

For fine adjustment use a suitable lens with large aperture.

Step 4: Fix the C-mount ring

To fix the C-mount ring, tighten both hexagon setscrews ④ (1.5 mm hex key) to a maximum torque of 1 Nm.

Limitations of C-mount lenses

Keep in mind that C-mount lenses could cause shadings at the edges of big sized sensors. Most C-mount lenses are able to illuminate a maximum image circle of 11 mm (2/3"), 16 mm (1") or 22 mm (4/3") diameter only. The pco.edge cameras have a sensor diagonal from 18.8 to 21.8 mm, therefore you have to use the ROI function for a shadowless image while using the c-mount lenses with the smaller image circle.

A3 WATER COOLING OPTION PCO.AQUAMATIC II

This is the re-cooling system for pco.edge cameras with water-cooling.

A3.1 SYSTEM COMPONENTS



	Description
1	pco.aquamatic
2	connection tube 5m PVC 3541-01 PCO (Colder NS212 fittings)
3	power supply (1.2m cable length)
4	power cable
5	camera cable 5m (FGG-RG58-NC3MX)
6	Innovatec Protect IP 11

Normally no maintenance and almost no care is required. Only the coolant's level of the reservoir (water tank) should be checked from time to time.

Only use Innovatec Protect IP for the pco.aquamatic! Do not use or add any other coolant or normal water! If you need to add cooling liquid in order to maintain the tank level, contact PCO for additional supply.

The coolant will turn yellow after some hours of operation. This is normal and no sign of wear or malfunction. The optimum pH-value is between 8 and 9 (check this value if you are concerned about the coolant's quality).

NOTE

The recommended service interval for the change of the coolant is four years.

A3.2 FIRST TIME INSTALLATION



Take care to place the unit on a flat and firm surface. Do not cover the cooling vents of the unit. Ensure free airflow around the pco.aquamatic for maximum cooling performance. All tubes and power cords need to run kink-free.

Before installation of the unit carefully read the Innovatek Protect IP safety datasheet (see [Innovatek Website](#)).



outlet flow



inlet flow

Follow Steps 1 – 6

- 1 Connect tubes to cooling unit and camera. The two arrows on the housing of the cooling unit only indicate flow direction. Either connection of the camera can be used for *in* or *out*.
- 2 Connect to power.
- 3 Open tank cover.
- 4 Turn power switch on (I).
- 5 Slowly fill in the coolant while the unit is running. Refill as needed to keep the level.
- 6 While the cooling liquid flows back to the tank make sure all air gets out of the system – this takes a few minutes (move hoses if necessary).

The cooling liquid tank is full when liquid level is approximately 1-2 cm from the top of the tank. The integrated pump only works when the pump chamber is completely filled. To ensure this Move hoses or remove air by evacuating. Tank capacity is approximately 500 ml.

After steps 1 – 6 are completed successfully the system is ready for operation.

NOTE

The hose connectors are waterproof in not connected state. Maybe they lose one drop of cooling liquid from time to time. There is no need to empty the hoses while storing the camera system.

A3.3 OPERATION



First connect the power out of the cooling unit with the power in of the pco.edge camera by using the *PCO WAT camera cable*.

The cooling unit provides two operation modes. Operation Mode on: the cooling unit switched on and provides permanently power to the camera. The camera can be switched on and off as needed.



Operation mode follow: the cooling unit turns on when the camera is switched on and vice versa.

Error Codes

The coolant temperature sensor is located in the coolant tank.

Temperature	Action
27°C	fan turns off
36°C	fan turns on
55°C	warning message
60°C	error message

If a warning level is passed, the Power LED blinks slowly and the Error LED displays the error code. If a failure level is passed, the Power LED blinks fast and the Error LED shows the error code.

power	error	Error / Failure
on	off	none
1Hz flash	one short flash	warning when temperature at 55 °C (also if sensor is defect or missing)
2Hz flash	one short flash	failure when temperature at 60 °C
1Hz flash	two short flashes	fan speed (also if a high deviation of the standard value is reached)

NOTE

The camera has its own protection circuit and will shut down Peltier cooling automatically when the electronics temperature exceeds safety level. The camera itself will keep on running, but sensor temperature will increase. (valid for air and water cooling!) If the camera and the water cooler have a different power supply, always first shut down camera and then the cooling system to avoid damages.

A3.4 DIMENSIONS

All dimensions are given in millimeter.

Weight: 4kg (completely filled coolant tank)

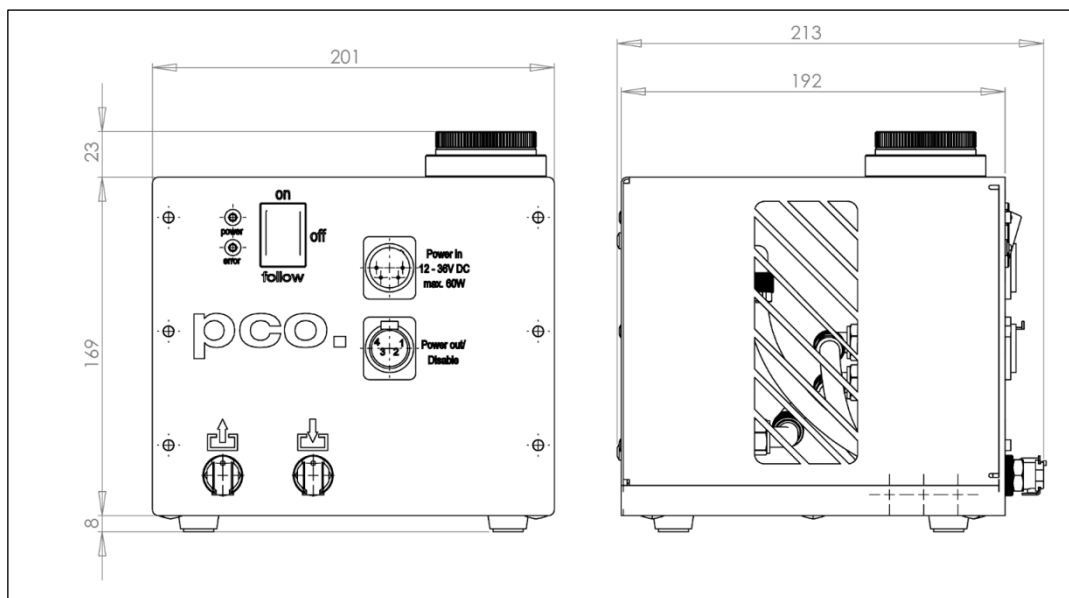

A3.5 YOUR OWN COOLING SYSTEM

You are not obliged to purchase the pco.aquamatic system - you may use your own water cooling device. A separate power supply will be provided to every pco.edge camera with water connection. The hardware of the pco.edge cameras with USB 3.0 Interface is designed to work with or without a water cooling system. A fan inside the camera provides adequate cooling anyway.

In case you use an own water cooling system, make sure the liquid you use to cool your camera is always ABOVE the dew point of the ambient temperature. In order to avoid any occurrence of condensation, use a cooling liquid at room temperature.

- A liquid flow rate of 1–2 litres per minute is sufficient
- Always use Innovatec Protect IP cooling fluid or an equivalent cooling fluid

A4 INTERFACES

Three different interfaces are available for the pco.edge camera. This chapter describes the installation and configuration of USB 3.0, Camera Link and Camera Link HS interfaces. Furthermore USB range extension, Ring Buffer and FIFO Buffer are described in detail.

A4.1 CABLING

Overview of the maximum cable lengths.

Camera Link HS

- available for pco.edge 4.2 / 5.5
- FOL fiber optic cable LC multi mode function
- standard: 10 m (multi mode)
- maximum: 300m (multi mode)

Camera Link full (2 cables)

- available for pco.edge 4.2 / 5.5
- standard: 3 m
- optional: 5 m
- maximum: 7 m (active cable)

USB 3.0

- available for pco.edge 3.1, pco.edge 4.2 LT, pco.edge 4.2 / 5.5
- type A connector to camera, type B to computer system
- standard: 3 m
- cable and proper PCI express board included in the camera system

NOTE

Only use cables, which are approved by PCO. Otherwise full functionality is not guaranteed.

A4.2 CAMERA LINK

A4.2.1 FRAME GRABBER INSTALLATION

Instructions for installing and testing the Silicon Software microEnable IV (ME4) Camera Link grabber card. This card is required to use a pco.edge with Camera Link interface. Installation must be performed by a technician, because high voltages can occur on the device.



WARNING

ELECTRIC SHOCK WARNING DUE TO VOLTAGE PARTS INSIDE

Risk of injury due to electric shock.

→ Always pull the main plug before opening the computer.

Install the latest silicon software runtime package before installing the hardware. (Download: <http://www.pco.de/support/>)

When working on a 64 bit operating system, make sure to install the proper (64 bit) runtime when a 64 bit application will be used. If the application is 32 bit, you need to install the 32 bit runtime accordingly.

- 1 Select full installation.
- 2 Let the program also update device drivers.
- 3 Shut your computer down, open the computer case and install the grabber card.
- 4 The grabber card should appear in the computer's device manager window. If not, reinstall the Silicon Software device driver.
- 5 After the installation, start the program microDiagnostics. (see next page)

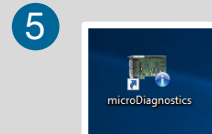
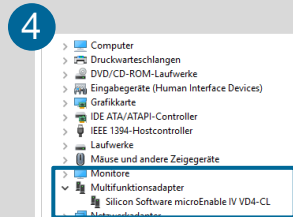
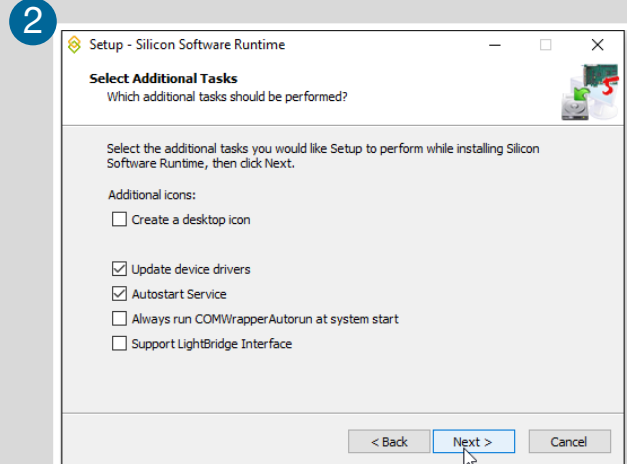
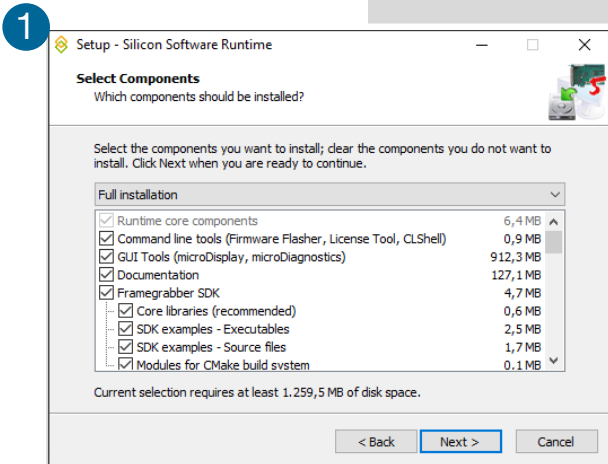

A4.2.2 MICRO DIAGNOSTICS TOOL

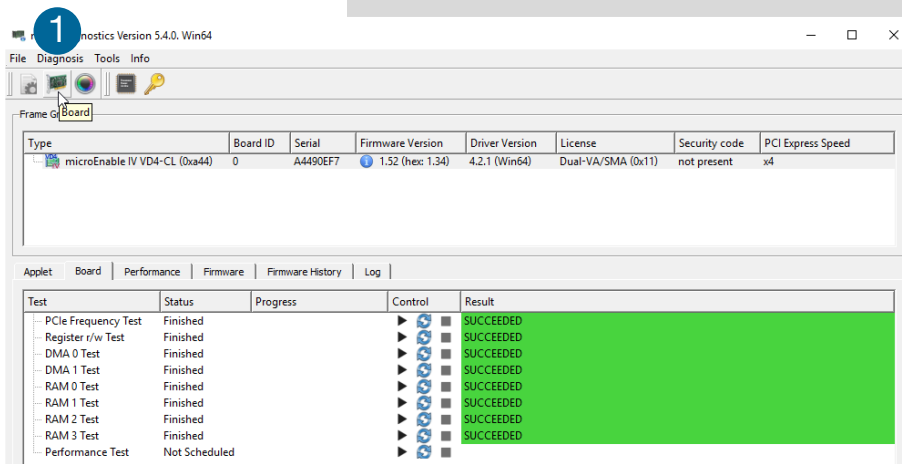

The **microDiagnostics** Tool works with microEnable IV (AD4 / VD4 boards for pco.edge Camera Link) frame grabber cards.

To test the board, select it and click **Board** 1 to start the test.

Upgrade to the supplied firmware. Select **Tools** → **Flash Board(s)** 3 and select the appropriate hap file. MicroDiagnostics provides the latest available firmware version of the installed runtime.

Then click on **Yes** when prompted to proceed. You must restart your computer after the firmware upgrade.

Test the performance of your frame grabber card: click on **Performance** 4 to start the test.

It is mandatory that **PCIe is Highspeed Capable** 5 is shown. Otherwise the board is probably not able to transfer the necessary data rate.

For further information or problems with mainboards contact our **support** section.

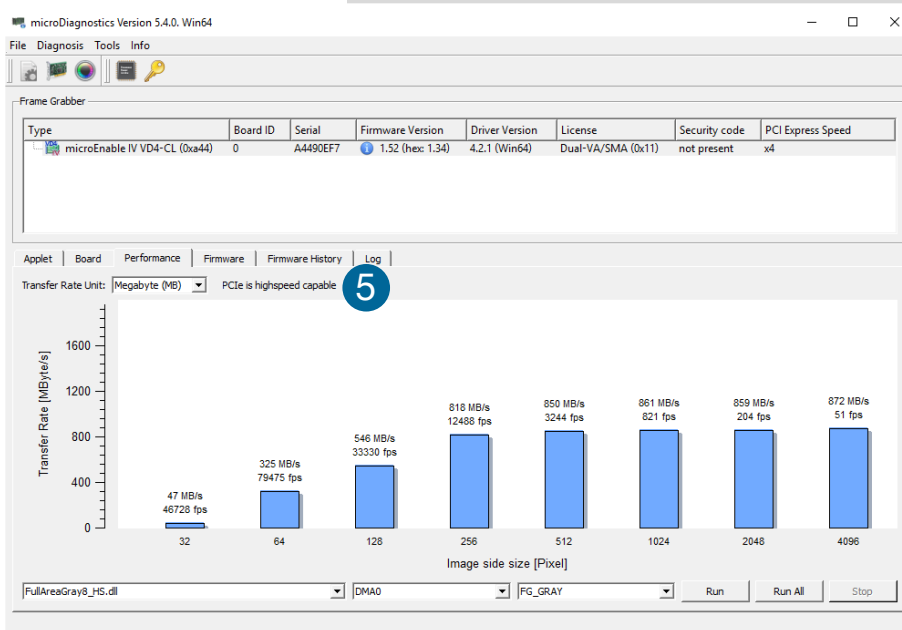
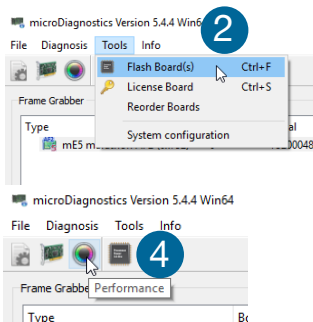

A4.3 CAMERA LINK HS INTERFACE

This chapter describes the installation of a dual or quad port Kaya frame grabber for PCO cameras with Camera Link HS interface.

A4.3.1 CABLING

- FOL fiber optical cable multi mode (LC connector):
 - standard : 10 m
 - maximum: up to 300m
- FOL fiber optical cable single mode (LC connector):
 - Up to: 10 km

A4.3.2 SYSTEM REQUIREMENTS

- PCIe Slot x8 or x16
- Recommended: Gen 3 and 8 lanes (see chapter **A4.3.5**)

A4.3.3 SAFETY INSTRUCTIONS



CLASS 1 LASER PRODUCT

Risk of injury due to laser beam.

- ➔ Do not look into the laser beam or at direct reflexes.
- ➔ Do not point the laser beam at persons.
- ➔ Manipulations of the laser device are not allowed.



WARNING

ELECTRIC SHOCK WARNING DUE TO VOLTAGE PARTS INSIDE

Risk of injury due to electric shock.

- ➔ Always pull the main plug before opening the computer.

A4.3.4 FRAME GRABBER INSTALLATION

Instructions for installing and testing the **Kaya Camera Link HS** grabber card. This card is required to be able to use a PCO camera with Camera Link HS interface. Installation must be performed by a technician, because high voltages can occur on the device.



WARNING

ELECTRIC SHOCK WARNING DUE TO VOLTAGE PARTS INSIDE

Risk of injury due to electric shock.

➔ Always pull the main plug before opening the computer.

Install the latest Kaya package. (Download approved version from: <http://www.pco.de/support/>)

Only 64-bit computer systems are supported.

- 1 Shutdown your computer, open the computer case and install the frame grabber card
- 2 Select proper folder at your computer
- 3 Deselect **Virtual COM port for serial communication**
- 4 The frame grabber card should be displayed within the device manager. If the device is not shown this way, reinstall the driver.
- 5 Start **Vision Point** application (see chapter **A4.3.5**)

1



2

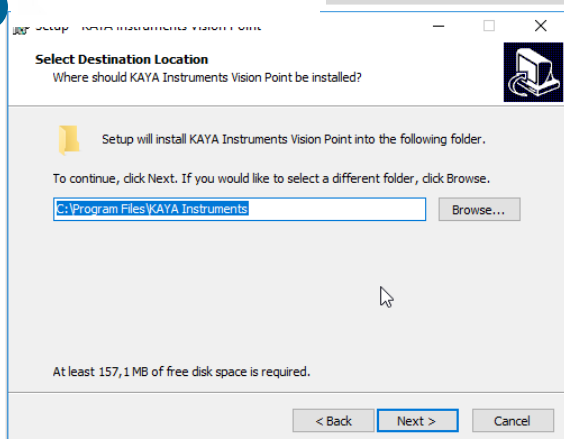

3

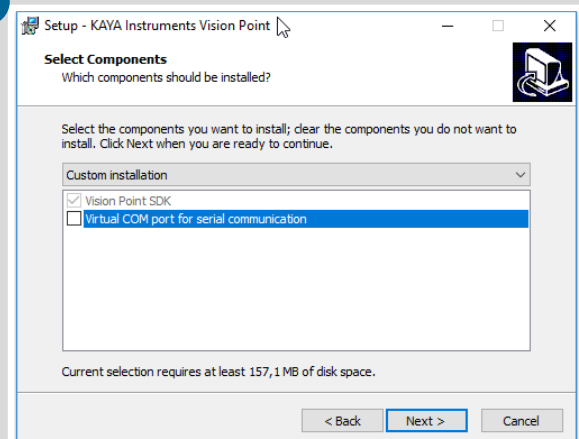

4

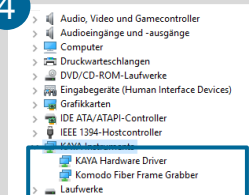

5

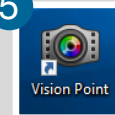

A4.3.5 VISION POINT SOFTWARE

After the installation is finished, open the Vision Point software and check the hardware information.

First click **Create new project**

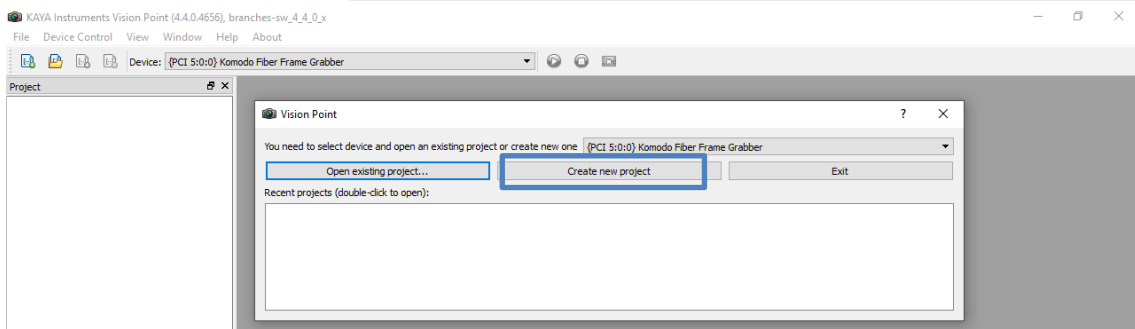

Take a look at the **Project** tab.

Click **Frame Grabber** → **Hardware Information**

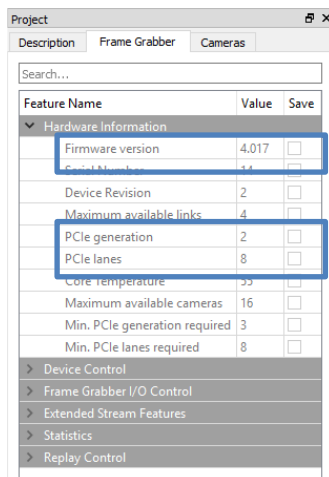

Check the following values:

- Firmware version: ≥ 4.017
- PCIe generation: 3 (see **Note**)
- PCIe lanes: 8

Grabber firmware must be updated if version is smaller than 4.017, see chapter **A4.3.6**.

NOTE

PCI Express Generation 2 / 3

If the grabber is installed in a PCIe Slot with only Gen2 capability and/or with only 4 PCIe lanes, memory bandwidth for image transfers is limited and images might be lost.

Vision Point software will give you a hint, if your system has limitations:

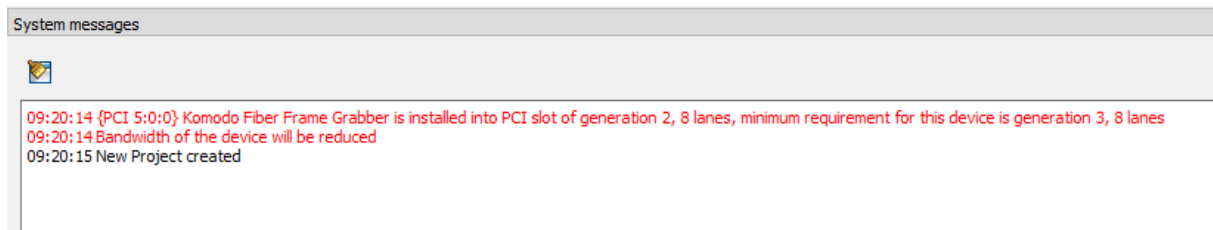

A4.3.6 UPDATE FIRMWARE OF THE GRABBER

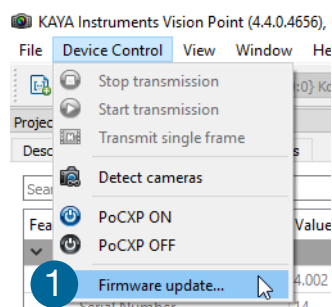

How to update the firmware of a Kaya frame grabber card.

- 1 Select **Device Control** → **Firmware update...**
- 2 Select proper firmware update file
- 3 Click next and wait till the update process is finished
- 4 Power down your computer, a restart is not sufficient.

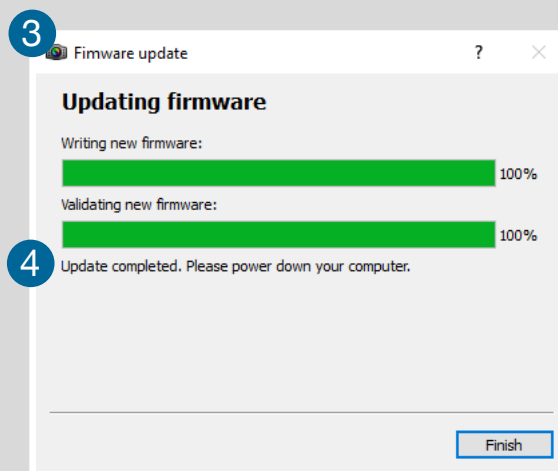
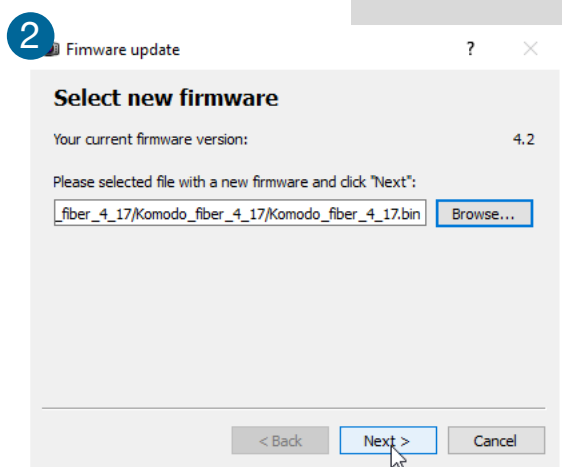

NOTE

Do not unplug

Do not unplug and/or switch off your computer during the update.

A4.4 USB 3.0

A4.4.1 USB 3.0 CARD INSTALLATION

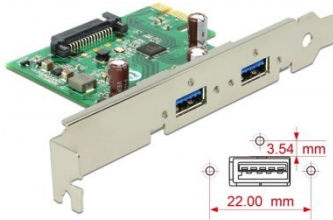

WARNING

An external USB 3.0 host controller card comes along with to each pco.edge USB 3.0 camera.

Hardware Installation

First shut down your computer and install the USB 3.0 Host Controller. Hardware Installation must be performed by a technician, because high voltages can occur on the device.

ELECTRIC SHOCK WARNING DUE TO VOLTAGE PARTS INSIDE

Risk of injury due to electrical shock.

➔ Always pull the main plug before opening the computer.

Driver Installation Instructions

- The installation files are located on the PCO USB stick in the pco.edge directory
 - Open Renesas USB 3.0 PCI Card installation.
 - If your current OS is Win7/8 and the User Account Control is enabled, a dialog prompts whether you wish to start the setup: accept with **Yes**.
- 1 At first the installation is prepared.
 - 2 Secondly the software components are copied automatically.
 - 3 Finally the installation is completed and the Delock USB 3.0 extension card can be used.

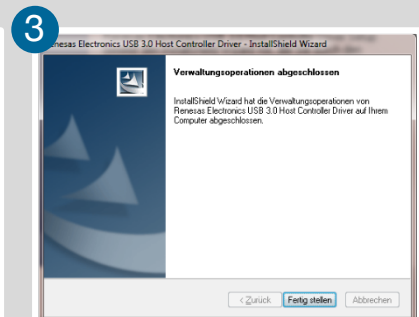
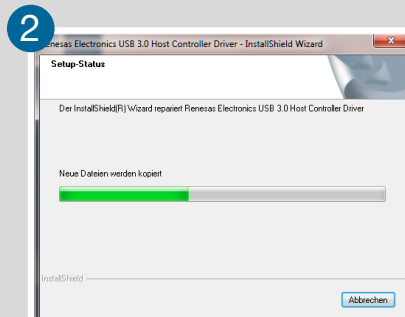
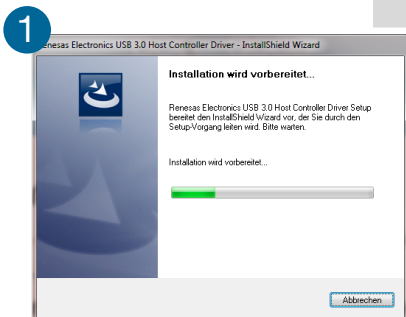

A4.4.2 DRIVER INSTALLATION

Install PCO USB 3.0 Driver

For pco.edge USB 3.0 you always need to install the latest **USB Driver version**. After these two screens **1** **2** the driver is completely installed.

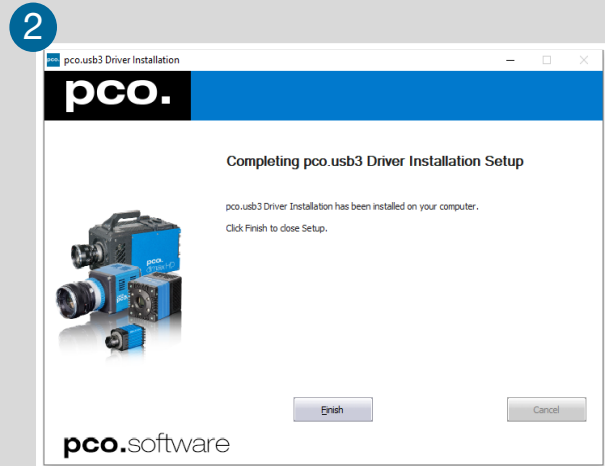
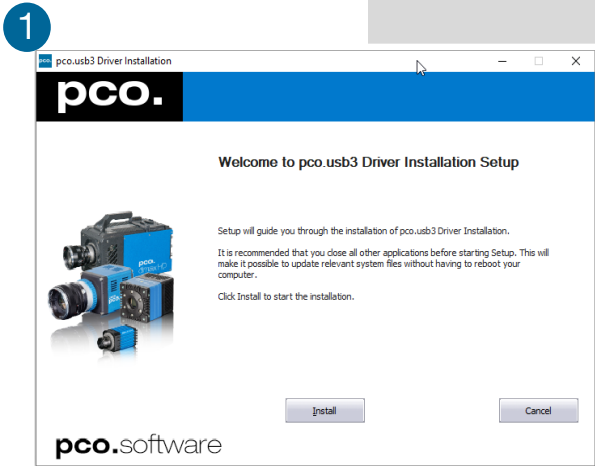

A4.4.3 RING BUFFER AND FIFO

The pco.edge with USB 3.0 interface has a small internal buffer memory integrated. Each recorded and read out image is directly transferred to this internal buffer and subsequently the image is transmitted to the computer, where it is either stored into the RAM or onto the hard disk drive. There are two transfer modes available: Ring Buffer and FIFO buffer which can be accessed via SDK function: PCO_SetStorageMode (see SDK manual).

If for some reasons the USB 3.0 runs slower than usual the Ring Buffer mode renders the last image faster than the FIFO Buffer mode. This may be helpful to focus on an object, for example.

Ring Buffer (in camera memory – standard mode)

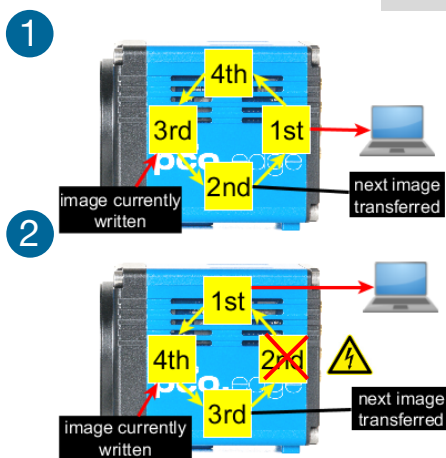

As described the read out and recorded image is directly transferred into the internal buffer memory. Subsequently the next image is stored to the next free space. For the transmission from the camera to the computer always the most recent image is used, which works fine in case the computer does not do anything else than transfer images to its internal storage memory (RAM). ①

Now, if the transmission speed of the computer system is interrupted by e.g. software, it can happen that images get lost, because in Ring Buffer mode the most recent image has to be transmitted to the PC. In case of a delay in transmission, the image in the memory, which waits for transmission will lose its status as most recent image to the next image, and will be disregarded for transmission. Hence this image will be irretrievably lost. ② Since in Ring Buffer modus always the most recent image is transferred, i.e. the best real-time transfer, it is the ideal modus for, e.g. focusing an object.

FIFO Buffer (in camera memory)

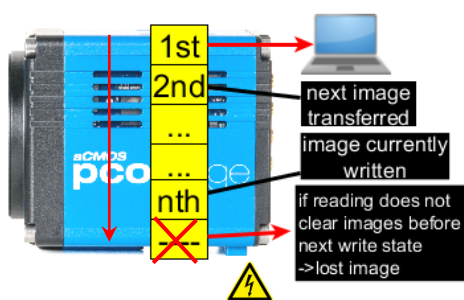

Like above the read out and the recorded image is directly transferred into the internal buffer memory. Subsequently the next image is stored to the next free space in memory. If all the memory space is occupied the camera stops storing. In FIFO buffer mode as the name suggests, FIFO = first-in first-out, the first stored image is read-out from the memory first and subsequently transmitted to the computer. This as well works fine in case the computer does not do anything else than transfer of images to its internal storage memory.

However, if the transmission speed of the computer system is interrupted by e.g. software, still the first stored image is readout, and then the next image is read out and transmitted. However there could be a delay time (but need not). If the slowdown fills the FIFO completely, the camera stops storing images and the next image will irretrievably lost as well, but in this mode it is lost before storing. This mode is ideal for users who need maximum transmission certainty; an image loss is very unlikely.

A5 BINNING WITH CMOS SENSORS

Binning means the summation of single pixels to form larger pixels and thereby improve the signal-to-noise ratio (SNR).

Binning: CCD image sensors

The term binning comes from scientific CCD image sensors. It is a process of adding charges of two or more pixels before they are read out of the sensor (pass the output amplifier) applied on very low light signals. The prominent feature of charge-coupled-devices (CCD) is the lossless transport or shifting of charge packages until an amplifier circuit converts them into a voltage at the output, where the main readout noise contribution occurs. Since the signal is increased before it is read out, and the image sensor's readout characteristics remain unchanged, binning improves the SNR, but the image sensor's resolution is reduced. The lossless transport feature of CCD image sensors makes binning possible.

Binning: CMOS image sensors

In general, binning is not possible in CMOS image sensors because voltages are processed and no charges are transported. In each pixel, the light generated charges are converted into voltages with the readout noise contribution of these amplifiers. Therefore, as opposed to CCD image sensors, if these voltages are combined, the readout noise would also be combined, which would not have the same positive effect on the SNR.

Nevertheless, such a summation or even an averaging would be beneficial for the SNR, but with a smaller impact compared to CCD image sensors. Since such CMOS binning cannot be done within the image sensor, it either has to be done in the camera or in the computer.

CMOS binning 1 – accumulation: pixel values can accumulate, causing an effective dynamic reduction or larger number formats, because the result might exceed the original format -- two times maximum 8 bit values will result in a 9 bit value. This is not a problem as long as 12 bit values are accumulated and transported as 16 bit images. However, in the case of scientific CMOS, if 16 bit values are transmitted in 16 bit images, only two times 15 bit maximum values are allowed. The signal of the binned pixels will be accumulated. Due to the properties of readout noise; the increase of the noise itself will only be as big as the square root of the number of binned pixels. The SNR will improve and in addition, a reduction of the stored image data is achieved.

CMOS binning 2 – averaging: pixel values can be averaged, which has the same effect on the SNR as accumulation due to the properties of noise. This would keep the image output format the same and would reduce the amount of image data that can be stored. When this type of CMOS binning is processed in the camera it is called hardware binning. This should not be confused with real binning in CCD image sensors, because the hardware that processes this binning is not much different from the hardware in computer processing. Therefore, the term hardware binning may be misleading.

NOTE

The default binning mode is accumulation. Averaging is not available within Camware.

A6 LIGHTSHEET SCANNING MODE

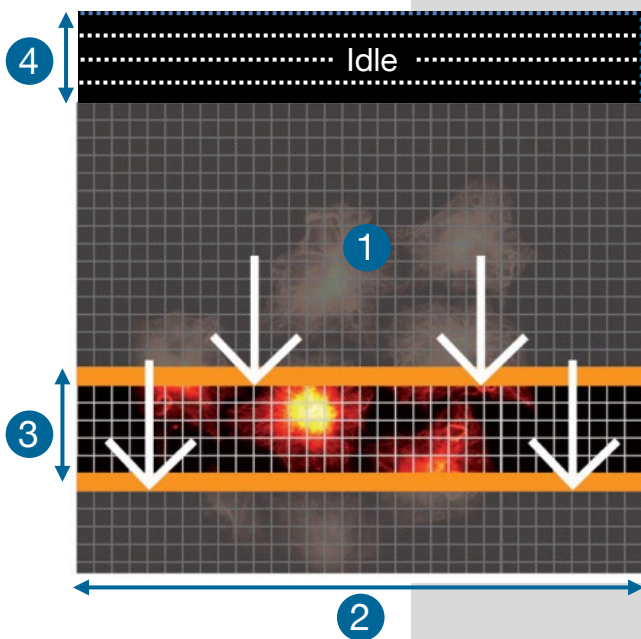

The pco.edge 'lightsheet scanning mode' is a special mode for lightsheet microscopy and only available for Camera Link versions via SDK (not in pco.camware).

It is based on Rolling Shutter mode and uses the readout mode **single top down** ① (Mode E see 7.2).

Standard line time (see 1.2) value is 40 μ s ② and it can be set from camera specific line time (see 1.2) up to 100 ms. An exposure area (between the orange bars, e.g. five lines ③) can be user defined. It is possible for the user to select the number of lines and the exposure time per line.

This user-defined capability makes it possible to synchronize the pco.edge cameras with a lightsheet microscope that requires this method of camera exposure timing

Workflow (only PCO SDK)

- Set Rolling Shutter mode
- Set readout format E ①
- Set line timing on (0x0001 \triangleq a CMOS_LINETIMING_PARAM_ON see sc2.defs.h) and set the appropriate line time ②
- Set number of exposure lines ③
- Set number of delay lines ④
- Trigger mode and acquire mode and HWIO settings are freely selectable

SDK settings: (see SDK manual)

SDK function	Parameter	Value
SC2_SDK_FUNC int WINAPI PCO_SetCmosLineTiming	wParameter	CMOS_LINETIMING_PARAM_ON ②
	wTimeBase	TIMEBASE_MS ②
	dwLineTime	e.g. 40 ②
SC2_SDK_FUNC int WINAPI PCO_SetCmosLineExposureDelay	dwExposureLines	e.g. 5 ③
	dwDelayLines	e.g. 4 ④
SC2_SDK_FUNC int WINAPI PCO_SetInterfaceOutputFormat	wDestInterface	SET_INTERFACE_CAMERA_LINK (value: 2)
	wFormat	SCMOS_FORMAT_TOP_BOTTOM (value: 0)

A7 IMAGE FILE FORMATS

There are several file formats available for saving camera images with pco.camware.

b16

The b16 16 bit format is similar to the bmp format. However, 16 bit pixel values are used instead of 8 bit pixel values.

The file format consists either of a Basic Header (6 Long-parameter) or an Extended Header (32 Long-parameter), the latter is optional for additional information. It might follow a variable comment field (ASCII code). Finally, there is the actual data set that is saved linearly (as in the case of BMP files).

With the exception of the first value, all parameters are Long Integers (4 Byte). The first 6 parameters must always exist. The rest of the parameters, as well as the comment field, are optional.

	Parameter	Function
1	pco-	the first 4 byte are the characters pco-
2	file size	file size in byte
3	header length	header size + comment field in byte
4	image width	image width in pixel
5	image height	image height in pixel
6	extended header	-1 (true), extended header follows
7	color mode	0 = monochrome camera, 1 = color camera
8	b/w min	black/white LUT-setting, minimum value
9	b/w max	black/white LUT-setting, maximum value
10	b/w linlog	black/white LUT-setting, 0 = linear, 1 = logarithmic
11	red min	red LUT-setting, minimum value
12	red max	red LUT-setting, maximum value
13	green min	green LUT-setting, minimum value
14	green max	green LUT-setting, maximum value
15	blue min	blue LUT-setting, minimum value
16	blue max	blue LUT-setting, maximum value
17	color linlog	color LUT-setting, 0 = linear, 1 = logarithmic
18-266	internal use	

Comment file in ASCII characters with variable length of 0...XX.
The length of the comment field must be documented in the header length field.

	16 bit pixel data
line 1, pixel 1	value of the first pixel
line 1, pixel 2	value of the second pixel
...	...

PCO recommends that all images should be saved first in the b16 or TIFF format. The advantage is to have the b16 or tiff images available all the time, having the maximum 16 bit information. Note that not all image analysis programs can accommodate 16 bit data. The 8 bit format saves only the information displayed on the monitor screen. The 16 bit information will be lost and cannot be recovered.

pcoraw

This 16 bit pco file format is based on the new BigTIFF format, thus allowing for file size > 4GB. A new pco proprietary compression scheme is added if it is necessary.

Standard File Formats

TIFF

Tag Image File Format, version 6.0 and lower. There is a 16bit monochrome and color image format.

BMP

Windows Bitmap Format, b/w or color 8 bit format-images, which have been saved in BMP format can be loaded later only as 8 bit images, i.e. part of the original information (16 bit) is lost.

FTS

Flexible Image Transport System, Version 3.1. It is a 16 bit image format defined by the NASA/Science Office of Standards and Technology (NOST) has defined this format. Some programs use the FIT extension for this format.

ASCII

16 bit format, some mathematical programs prefer ASCII data.

JPG

JPEG (named after the Joint Photographic Experts Group who created the standard) is a commonly used method of lossy compression for photographic images. The degree of compression can be adjusted, allowing a selectable tradeoff between storage size and image quality.

JP2

JPEG 2000 is a wavelet-based image compression standard and coding system. It was created by the Joint Photographic Experts Group committee in the year 2000 with the intention of superseding their original discrete cosine transform-based JPEG standard (created 1992).

AVI

Audio Video Interleave is a multimedia container format introduced by Microsoft in November 1992 as part of its Video for Windows technology.

MPG

MPEG-1, similar to JPEG, is a standard for lossy compression of video and audio developed by the Moving Picture Experts Group (MPEG).

WMV

Windows Media Video (WMV) is a compressed video format for several proprietary codecs developed by Microsoft. The original video format, known as WMV, was originally designed for Internet streaming applications, as a competitor to RealVideo.

A8 CUSTOMER SERVICE

A8.1 SERVICE

The camera is designed to operate with no need of special adjustments or periodic inspections.

A8.2 MAINTENANCE



CAUTION

UNPLUG CAMERA BEFORE CLEANING

Risk of injury due to electric shock!

- Unplug the camera from any power supply before cleaning it.

NOTICE

CLEANING

- Use a soft, dry cloth for cleaning the camera.
- Do not clean the input window unless it is absolutely necessary.
- Be careful and avoid scratches and damage to the input window surface.
- Do not use liquid cleaners or sprays.

NOTICE

LENS CLEANING

- The lens is best cleaned with pressurized air or with liquid cleaners such as pure alcohol or with special optical cleaners that are available at premium photo stores.
- Use a cotton swab dipped in pure alcohol or optical cleaning liquid and wipe only on the glass surface.
- Do not get any cleaning liquid on the metallic parts such as the lens thread, because tiny detached particles may scratch the surface.

NOTICE

CLEANING LIQUIDS

Aggressive cleaning liquids can damage your camera.

- Never use aggressive cleaning liquids such as gasoline, acetone, spirits or nitro cleanser.
- Every time the input window is cleaned, there is the possibility of surface damage.

NOTICE

PROTECTIVE CAP

Always store the camera with the protective cap or with a lens mounted to avoid dust and dirt on the input window.

A8.3 RECYCLING



To dispose your camera, send it to PCO or take it to a local recycling center.

The camera includes electronic devices, which can contain materials harmful to the environment. These electronic devices must be recycled.

A8.4 TROUBLE SHOOTING

Use pco.camware to create logfiles for the PCO support.

How to Create Logfiles

Enable Logging ①

Open **? Help** menu, select **Logging** and then **Enable Logging**. The pco.camware will ask you to press **YES** ② to activate **Logfiles** after a restart of the software.

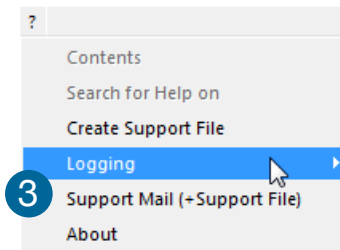

Enable Logging ①

Clear Logfiles

Explore Logfiles

Disable Logging

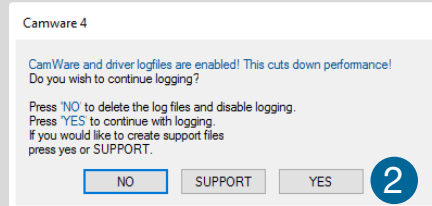

Repeat Workflow

The workflow which produces the error must be repeated while logging is enabled.

Support Mail (+Support File) ③

Open **? Help** menu, select **Support Mail (+Support File)** and a support file with all necessary files is created

The pco.camware opens a new email addressed to support@pco.de, attach the **Support File** manually to this mail and send the mail to the PCO support.

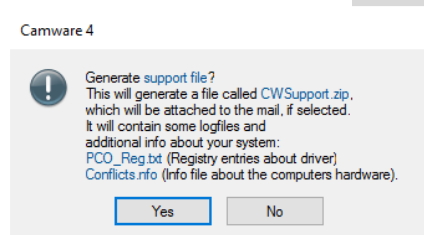

Alternatively use the support form on our website: <http://www.pco.de/support/> and upload the support file.

To Speed up Your Request

Give us the following information:

- Describe your problem!
- Your application?
- Your camera:
 - Type and version
 - Serial number
- Your setup:
 - Software version
 - Operating system
 - Processor and memory
 - Graphics card

Firmware, Software and Driver Update

You will find all necessary software and drivers on the accompanying USB storage device. For the latest versions check PCO [website](#).

A9 INDEX

NOTE:

The mentioned page is always the starting page of a chapter!

Key word	Chapter	Page
Aquamatic	A3	37
Binning	A5	51
C -mount conversion	A2.3	36
Cable lengths	A4.1	41
Camware installation	4.2	10
Camware software	7	22
Camera Link	A4.2	42
Camera Link HS	A4.3	44
Cleaning	A8	55
Cuda nvidia driver	4.1	9
D imensions	A1.2	28
Driver installation	4.1	9
G lobal Reset	6.3	20
Global Shutter	6.2	17
Input / Output possibilities	7.1	22
Interfaces	A4	41
Lightsheet scanning mode	A6	52
R ear connections	A1.3	31
Rolling Shutter	6.1	13
S afety instructions	2	7
Support file	A8.4	56
U SB	A4.4	48
W ater cooling	A3	37

ABOUT PCO



pco.

pco.history

“PCO” stands for what we are: a Pioneer in Cameras and Optoelectronics. With 30 years of expert knowledge and experience PCO has forged ahead to becoming a leading specialist and innovator in digital imaging used in scientific and industrial applications such as life and physical science, high-speed imaging and machine vision. However, the beginning of PCO’s story of success dates back to the 1980s and a research project of the founder, Dr. Emil Ott, who was working at the Technical University Munich for the Chair of Technical Electrophysics. While performing measurements with intensified slow scan cameras, Dr. Ott realized that the existing standard did not meet the sophisticated requirements of scientific applications – and so PCO came to life in 1987. With a small team of engineers Dr. Ott began to develop his first image intensified camera followed by several variations on the original model, geared to overcoming all the existing flaws and surpassing standards of the day. During these early years PCO developed a now well established core of advance technologies used as the foundation to develop cutting edge products.

In the early 1990s PCO expanded its business activities to the global market by successfully establishing an international network of highly trained sales partners and customers. We entered additional fields beyond traditional scientific research expanding the potential for our cameras’ applications in life science, automotive testing and even broadcasting. This step paved the way for a wide range of innovative highlights:

As of 2017, PCO has three decades of technical know-how and expert knowledge in the development and manufacturing of high-performing camera systems. In-house competence of all significant technical disciplines and partnering with leading image sensors manufactures ensures cutting edge sCMOS, CMOS and CCD technology for all PCO cameras.

pco.prospect

“If you want to do something special, particularly in the high end fields, you have to develop your own image sensors. So we work with partner companies who develop tailored sensors made especially for us. This is something we are doing continuously, so we’re already working on the next generation of cameras that we will introduce in the coming years” – Dr. Emil Ott.

In PCO’s first 30 years, Dr. Emil Ott took a company that he started right after finishing university and has built it into a major player in scientific and industrial cameras – and there’s plenty more to come.

pco.

An Excelitas Technologies Brand