

# Linea Color CL

## Camera User's Manual

4k and 8k Color CMOS Line Scan

sensors | **cameras** | frame grabbers | processors | software | vision solutions



P/N: 03-032-20231-02  
[www.teledynedalsa.com](http://www.teledynedalsa.com)



## Notice

© 2017 Teledyne DALSA

All information provided in this manual is believed to be accurate and reliable. No responsibility is assumed by Teledyne DALSA for its use. Teledyne DALSA reserves the right to make changes to this information without notice. Reproduction of this manual in whole or in part, by any means, is prohibited without prior permission having been obtained from Teledyne DALSA.

Microsoft and Windows are registered trademarks of Microsoft Corporation in the United States and other countries. Windows, Windows 7, Windows 8 are trademarks of Microsoft Corporation.

All other trademarks or intellectual property mentioned herein belong to their respective owners.

Document Date: March 10, 2017

Document Number: 03-032-20231-02

### Contact Teledyne DALSA

Teledyne DALSA is headquartered in Waterloo, Ontario, Canada. We have sales offices in the USA, Europe and Asia, plus a worldwide network of representatives and agents to serve you efficiently. Contact information for sales and support inquiries, plus links to maps and directions to our offices, can be found here:

**Sales Offices:** <http://www.teledynedalsa.com/corp/contact/offices/>

**Technical Support:** <http://www.teledynedalsa.com/imaging/support/>

### About Teledyne DALSA

Teledyne DALSA is an international high performance semiconductor and electronics company that designs, develops, manufactures, and markets digital imaging products and solutions, in addition to providing wafer foundry services.

Teledyne DALSA Digital Imaging offers the widest range of machine vision components in the world. From industry-leading image sensors through powerful and sophisticated cameras, frame grabbers, vision processors and software to easy-to-use vision appliances and custom vision modules.

# Contents

Camera User's Manual	1
System Precautions	5
The Linea Color Camera	6
Description	6
Part Numbers and Software Requirements	7
Camera Performance Specifications	7
Supported Industry Standards	9
Responsivity	9
Spatial Correction and Bilinear Sensor Design	10
Mechanicals	14
Quick, Simple Steps to Acquire an Image	15
Software and Hardware Setup	15
Setup Steps: Overview	15
Step 1: Install and configure the frame grabber, and software (including GUI)	16
Step 2: Connect Data, Trigger, and Power Cables	17
Camera Link Timing Diagrams	19
AOI Rules	27
Input Signals	28
Output Signals	29
Step 3: Establish Communication with the Camera	30
Using Sopera CamExpert with Linea Cameras	33
4. Camera Operation	37
Factory Settings	37
Check Camera and Sensor Information	37
Verify Temperature and Voltage	38
Saving and Restoring Camera Settings	38
Camera Link Configuration	40
Trigger Modes	40
Exposure Controls	40
Exposure Modes in Detail	41
Set Line Rate	44
Set Exposure Time	45
Control Gain and Black Level	45
Set Image Size	45
Set Baud Rate	46
Pixel Format	46
Camera Direction Control	47
Pixel Readout Direction (Mirroring Mode)	47
Resetting the Camera	47
Calibrating the Camera	48
Appendix A: GenICam Commands	52

Camera Information Category .....	52
Camera Control Category.....	55
Flat Field Category .....	60
Image Format Control Category .....	63
Image Filters.....	66
Binning.....	67
Area of Interest (AOI) Setup .....	67
Transport Layer Control Category .....	70
Acquisition and Transfer Control Category.....	72
Serial Port Control Category.....	73
File Access Control Category .....	74
Appendix B: ASCII Commands .....	78
Appendix C: Quick Setup and Image Acquisition .....	90
Appendix D: The Sensor Window .....	93
EMC Declaration of Conformity .....	95
Revision History .....	96
Index .....	97

---

# System Precautions

## Precautions

Read these precautions and this manual carefully before using the camera. Confirm that the camera's packaging is undamaged before opening it. If the packaging is damaged please contact the related logistics personnel.

Do not open the housing of the camera. The warranty is voided if the housing is opened.

Keep the camera housing temperature in a range of 0 °C to +65 °C during operation.

Do not operate the camera in the vicinity of strong electromagnetic fields. In addition, avoid electrostatic charging, violent vibration, and excess moisture.

To clean the device, avoid electrostatic charging by using a dry, clean absorbent cotton cloth dampened with a small quantity of pure alcohol. Do not use methylated alcohol. To clean the surface of the camera housing, use a soft, dry cloth. To remove severe stains use a soft cloth dampened with a small quantity of neutral detergent and then wipe dry. Do not use volatile solvents such as benzene and thinners, as they can damage the surface finish. Further cleaning instructions are below.

Though this camera supports hot plugging, it is recommended that you power down and disconnect power to the camera before you add or replace system components.

## Electrostatic Discharge and the CMOS Sensor

Image sensors and the camera bodies housing are susceptible to damage from electrostatic discharge (ESD). Electrostatic charge introduced to the sensor window surface can induce charge buildup on the underside of the window that cannot be readily dissipated by the dry nitrogen gas in the sensor package cavity. The charge normally dissipates within 24 hours and the sensor returns to normal operation.

Additional information on cleaning the sensor window and protecting it against dust, oil, blemishes, and scratches can be found here, [Appendix D: The Sensor Window](#).

# The Linea Color Camera

---

## Description

The new Linea Color™ line scan camera delivers the exceptional performance and features found in Teledyne DALSA's current line-up of high-end cameras at an unprecedented price point.

Based on bilinear CMOS technology, the Linea Color camera has a 4096 or 8192 pixel resolution, 7.04 μm x 7.04 μm pixel array, and a 48 kHz maximum line rate.

With excellent sensitivity and speed, the Linea Color camera surpasses the requirements of demanding applications—such as materials grading, web inspection, and general purpose machine vision.

The Linea Color camera is compact, lightweight, and robust with many attractive features, including flat-field correction, multiple ROI, multiple user configuration sets, and calibration coefficients for various lighting conditions.

The GenICam™ compliant Linea camera is easy to set up and integrate using a GUI, such as Teledyne DALSA's Sopera™ camera configuration utility CamExpert, or an ASCII interface using three letter commands.

## Key Features

- CMOS color bilinear line scan
- Up to 48 kHz line rates
- 4096 x 2 and 8192 x 2 pixel resolution
- Low cost and compact
- Camera Link interface

## Programmability

- GenICam or ASCII compliant interfacing
- Multiple Regions of Interest for calibration and data reduction
- 8 or 12 bit output, selectable
- Smart flat field and lens shading correction
- 8 programmable coefficient sets

## Applications

- Automated optical inspection
- High performance sorting systems
- Materials grading
- Web inspection
- General purpose machine vision

# Part Numbers and Software Requirements

This manual covers the Linea Color camera models summarized below. New models are added to this manual as they are released by Teledyne DALSA.

Camera	Resolution	Pixel size	Max. Line Rate	Lens Mount (threaded)	Product Number
Linea 4k CL	4096 x 2	7.04 $\mu\text{m}$ x 7.04 $\mu\text{m}$	48 kHz	M42 x 1	LA-CC-04K05B-xx-R
Linea 8k CL	8192 x 2	7.04 $\mu\text{m}$ x 7.04 $\mu\text{m}$	48 kHz	M72 x 0.75	LA-CC-08K05B-xx-R

Software	Product Number / Version Number
Camera firmware	Embedded within camera
GenICam™ support (XML camera description file)	Embedded within camera
Sapera LT, including CamExpert GUI application and GenICam for Camera Link imaging driver	Version 7.30 or later

# Camera Performance Specifications

Specifications	Performance
Imager Format	CMOS bilinear color line scan
Resolution	4096 x 2 pixel lines: 4096 x 1 pixel line Green, and 4096 x 1 pixel line alternating Red-Blue (4K)
	8192 x 2 pixel lines: 8192 x 1 pixel line Green, and 8192 x 1 pixel line alternating Red-Blue (8K)
Pixel Size	7.04 $\mu\text{m}$ x 7.04 $\mu\text{m}$
Full Well Capacity	15K e <sup>-</sup> @ minimum gain of 1x
Line Rate	Minimum from 0 kHz maximum up to 48 KHz.
Exposure Time	4 $\mu\text{s}$ minimum to 3,000 $\mu\text{s}$ maximum
Bit Depth	8 bit, 12 bit
<b>Connectors and Mechanicals</b>	
Control & Data Interface	Base, Medium, Full, or Deca Camera Link configurations—SDR-26
Power Connector	Hirose 6-pin circular
Power Supply	+ 12 V to + 24 V DC
Power Dissipation	8 W (4K), 11 W (8K)
Size	62 mm (W) x 62 mm (H) x 37 mm (D) (4K)
	76 mm (W) x 76 mm (H) x 36.7 mm (D) (8K)
Mass	<190g (4K)
	< 360 g (8K)
Operating Temp	0 °C to +65 °C, front plate temperature
<b>Optical Interface</b>	
Lens Mount	M72 x 0.75, F-mount* (8K) M42 x 1, F mount adapters available
Sensor to Camera Front Distance	12 mm
Sensor Alignment (aligned to sides of camera)	

Flatness	50 $\mu\text{m}$
$\ominus y$ (parallelism)	0.08° or 81 $\mu\text{m}$
x	$\pm 300 \mu\text{m}$
y	$\pm 300 \mu\text{m}$
z	$\pm 300 \mu\text{m}$
$\ominus z$	$\pm 0.3^\circ$
<b>Compliance</b>	
Regulatory Compliance	CE and RoHS, GenICam

\* F-mount lenses are optimized for a maximum image circle of 43.2 mm. The camera sensor is 57.67mm long. Using an F-mount lens will generate a good image for the center 6008 pixels. However, pixels beyond this range may suffer from optical distortion caused by the lens. If an application requires the use of an F-mount lens with cameras, contact Customer Support for additional details regarding the use of F-mount lenses and for access to a suitable F-mount-to-M72 adapter.

Operating ranges	Performance		
	Red	Green	Blue
Dynamic Range	63dB	63dB	63dB
Random Noise	2.72DN rms	2.72DN rms	2.72DN rms
Broadband Responsivity	See responsivity graph		
Gain	1x to 10x Nominal Range (not including individual RGB gains for white balance)		
DC Offset	<16DN		
PRNU	<1.5%@50% Sat		
FPN	5.6DN		
SEE	11.1nJ/cm <sup>2</sup>	13.3 nJ/cm <sup>2</sup>	12.8 nJ/cm <sup>2</sup>
NEE	7.55pJ/cm <sup>2</sup>	9.00pJ/cm <sup>2</sup>	8.77pJ/cm <sup>2</sup>
Antiblooming	>100x Saturation		
Integral non-linearity	<2%DN		

All data quoted in 12 bit data format at 1x gain

## Environmental Specifications

Environmental Specifications	Performance
Storage temperature range	-20 °C to +80 °C
Humidity (storage and operation)	15% to 85% relative, non-condensing
MTBF (mean time between failures)	>100,000 hours, typical field operation

## Compliance, EMI Certifications

Compliance
EN 55011, FCC Part 15, CISPR 11, and ICES-003 Class A Radiated Emissions Requirements.
EN 55024, and EN 61326-1 Immunity to Disturbance.
RoHS per EU Directive 2002/95/EC and WEEE per EU Directive 2002/96/EC and China Electronic Industry Standard SJ/T11364-2006
GenICam XML Description File, Superset of the GenICam™ Standard Features Naming Convention specification V1.5, Camera Link Serial Communication: GenICam™ Generic Control Protocol (GenCP V1.0)

## Flash Memory Size

Camera	Flash Memory Size
LA-CC-04K05B	16 MBytes
LA-CC-08K05B	16 MBytes



---

# Supported Industry Standards

## GenICam™

The camera is GenICam compliant. They implement a superset of the GenICam™ Standard Features Naming Convention specification V1.5. This description takes the form of an XML device description file respecting the syntax defined by the GenAPI module of the GenICam™ specification. The camera uses the GenICam™ Generic Control Protocol (GenCP V1.0) to communicate over the Camera Link serial port. For more information see [www.genicam.org](http://www.genicam.org).

---

## Responsivity

The responsivity graph describes the sensor response to different wavelengths of light (excluding lens and light source characteristics).

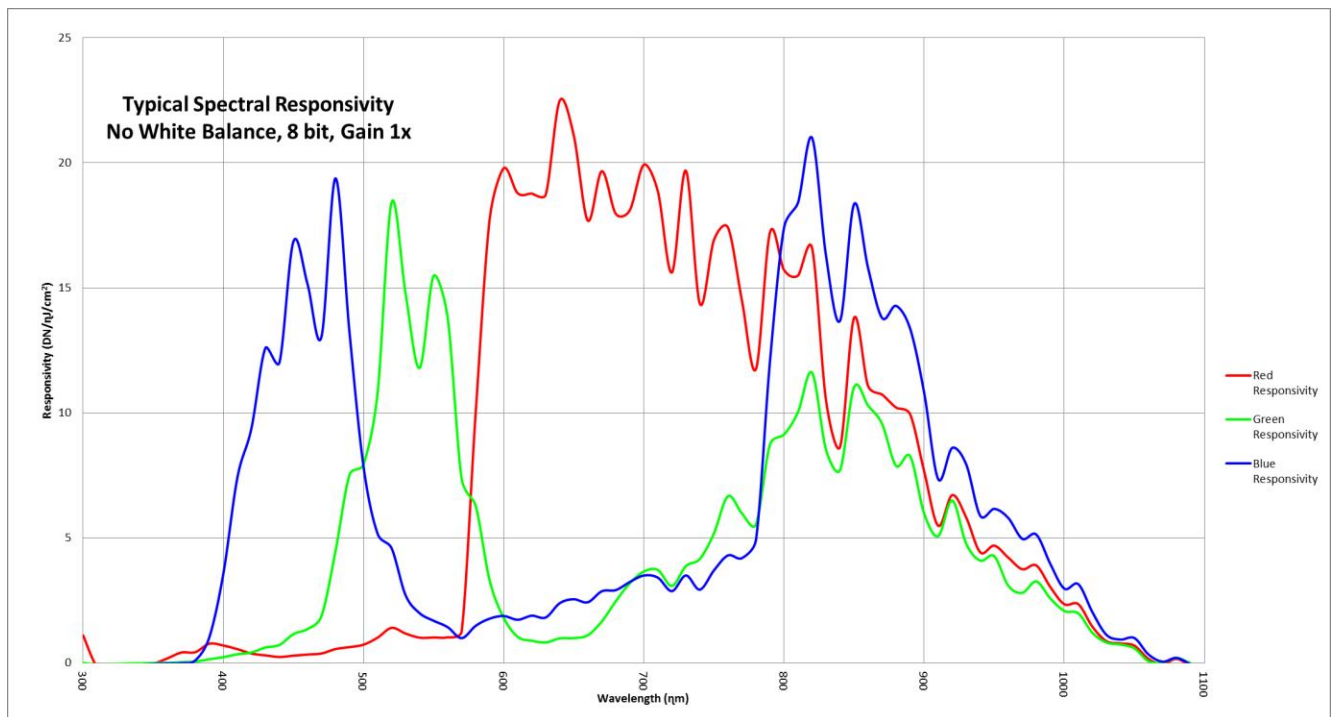

---

# Spatial Correction and Bilinear Sensor Design

The bilinear color camera is based on Teledyne DALSA's bilinear CMOS sensor and designed such that the first line of this two line sensor has red (R) and blue (B) alternating pixels, while the second line has all green (G) pixels. The sensor has a 100% fill factor with zero gap between the two lines, which minimizes any artifact due to spatial correction. The G channel can be used as a monochrome output.

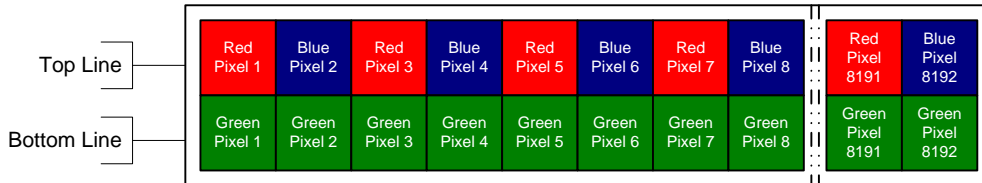

Note: The interpolation procedure does not work on the first and last pixels. As a result, the number of effective full color (RGB) pixels is reduced by 2 to 8190 pixels.

There is no spacing between the sensor lines. When the image passes the two lines of pixels, the red/blue and green components for the same image location are captured at a different time as dictated by the line spacing. The camera automatically corrects for the line spacing to ensure that the red/blue and green components of the image pixel are all aligned when output. However, this is only correct when the object pixel size is square; i.e., the distance moved by the object for one EXSYNC period is equal to the width of the object pixel. In some applications it may not be possible to achieve a 'square' object pixel as fine adjustment of the lens magnification and/or the distance moved for each EXSYNC period is not possible. This scenario may be especially apparent when trying to integrate the camera into an existing system.

When it is not possible to generate a square object pixel, color artifacts will occur in the scan direction and is particularly noticeable at sharp edge transitions. The size of the edge artifact is proportional to how far the pixel is from square. To correct for this, the camera has a feature, Line Spatial Correction (or three letter command ssa), which allows fine adjustment of the compensation mechanism the camera uses to correct for the line spacing.

The default setting for this feature is 1, which is set for square object pixels. The setting can be adjusted from 0 to 3 to compensate for rectangular pixels—whether they are too long or too short.

The following examples of image artifacts show black to white image transitions and the associated corrected image after applying a specific ssa setting.

**Example 1. Target speed adjusted for square pixels**

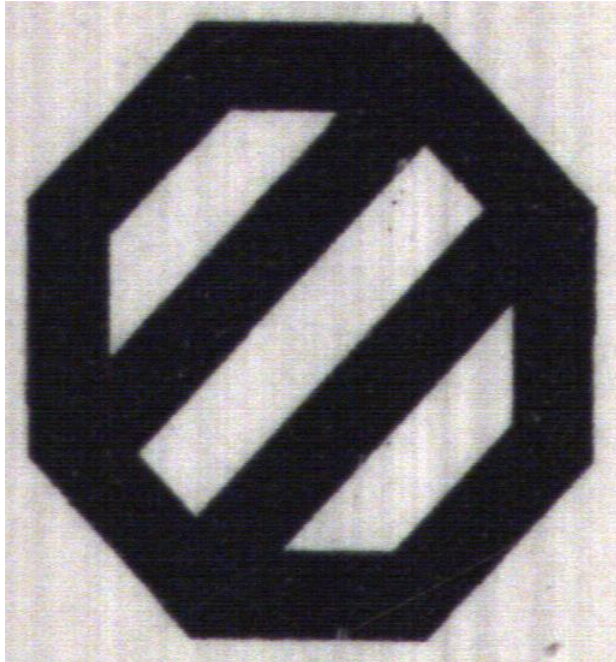

Line Spatial Correction = 1 (ssa = 1). This is the default condition.

**Example 2. Target running slower than example 1. same EXSYNC (trigger) frequency**

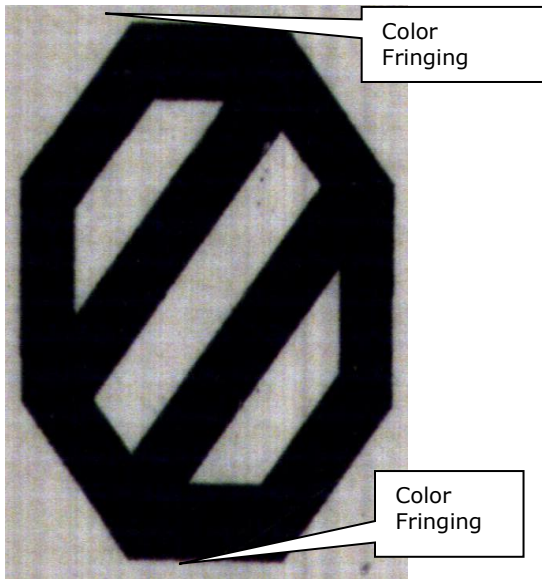

Line Spatial Correction = 1 (ssa = 1)

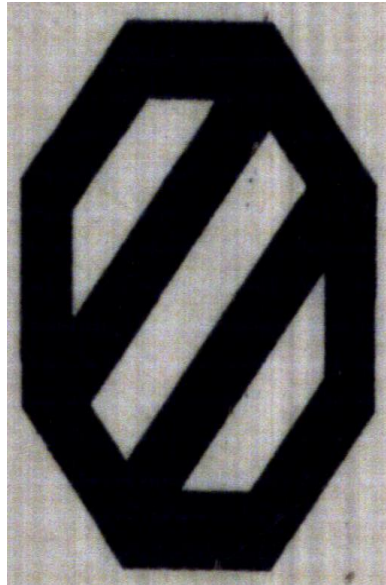

Line Spatial Correction = 2 (ssa = 2)

**Example 3. Target running faster than example 1. same EXSYNC (trigger) frequency**

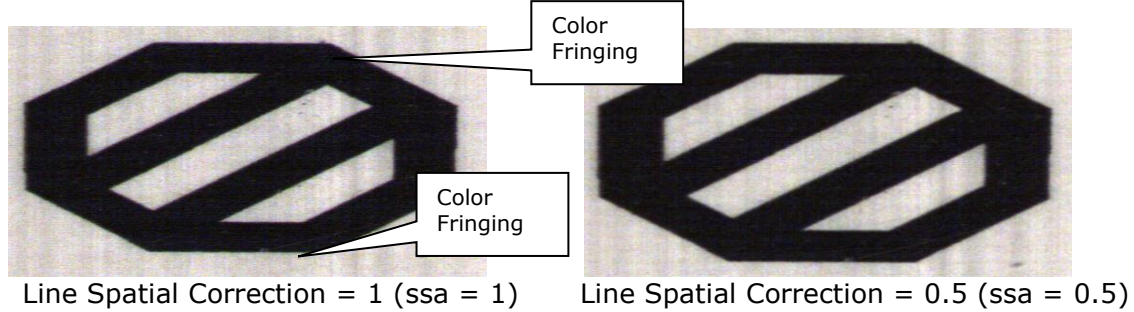

**Parallax Correction**

When the camera is not perpendicular to the object surface the camera will exhibit color. The parallax distortion increases when imaging at steep angles relative to the camera's imaging plane. This is an optical effect caused by the line spacing of the three individual colors. This spacing results in a different magnification for each line at high angles. As shown in the figure below, there is color distortion at the extreme ends of the image but at the center of the image the color distortion does not show up.

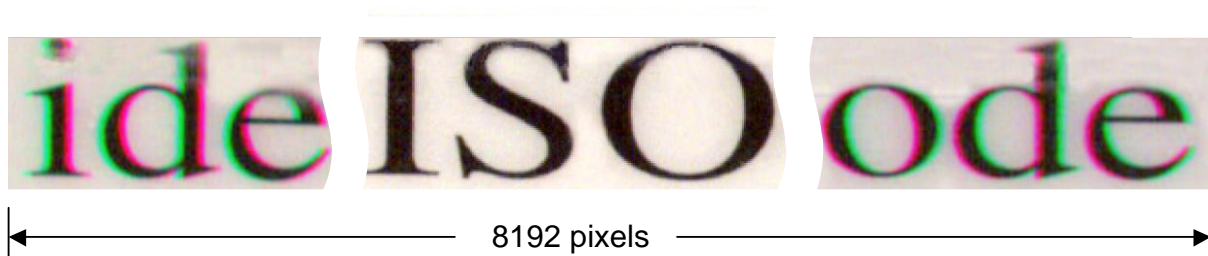

Figure 1: Example Image with Horizontal Color Alignment Issues

Using the camera's Parallax Correction feature, the optical magnification for each line is adjusted such that colors can be lined up at the extreme ends of the image without affecting the center. Using the feature Image Distortion Correction Mode ( $shm = 1$ ) this feature can be turned on. Using the feature Image Distortion Correction Line Selector the user can select red and green to correct the distortion. Note: the red and green lines are adjusted to align with the center blue line. Image Distortion Parallax Correction Pixel Stretch ( $sha$  - Set horizontal alignment in float  $f < \text{value } 0-3 >$ ) is used to add the amount of correction needed to the image. The value entered here must be between 0 and 3 (decimal values are accepted).

Image Distortion Correction Mode	Off
Image Distortion Correction Algorithm	ParallaxCorrection
Image Distortion Correction Line Selector	Red
Image Distortion Parallax Correction Pixel Stretch	0

Figure 2: CamExpert Parallax Correction Controls

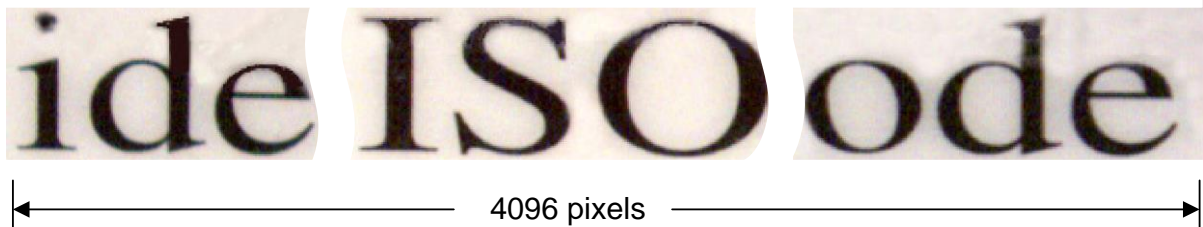

Figure 3: Figure 4 Corrected Image

The figure above is the same image corrected using the parallax correction. In this example the value of 3 was used to correct the image.

### Camera Direction Example

When in high sensitivity mode, you can select either forward or reverse sensor direction. See [Camera Direction Control](#) for details. Selectable direction accommodates object direction change on a web and allows you to mount the camera "upside down".

Note: The example here assumes the use of a lens (which inverts the image).

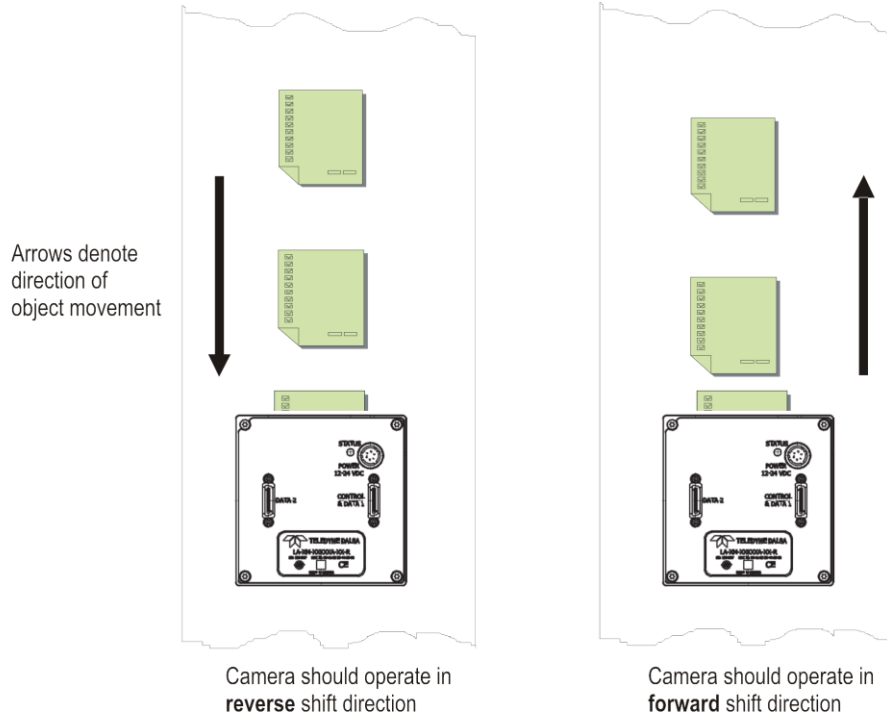

Figure 5: Object Movement and Camera Direction Example, with a Lens

# Mechanicals

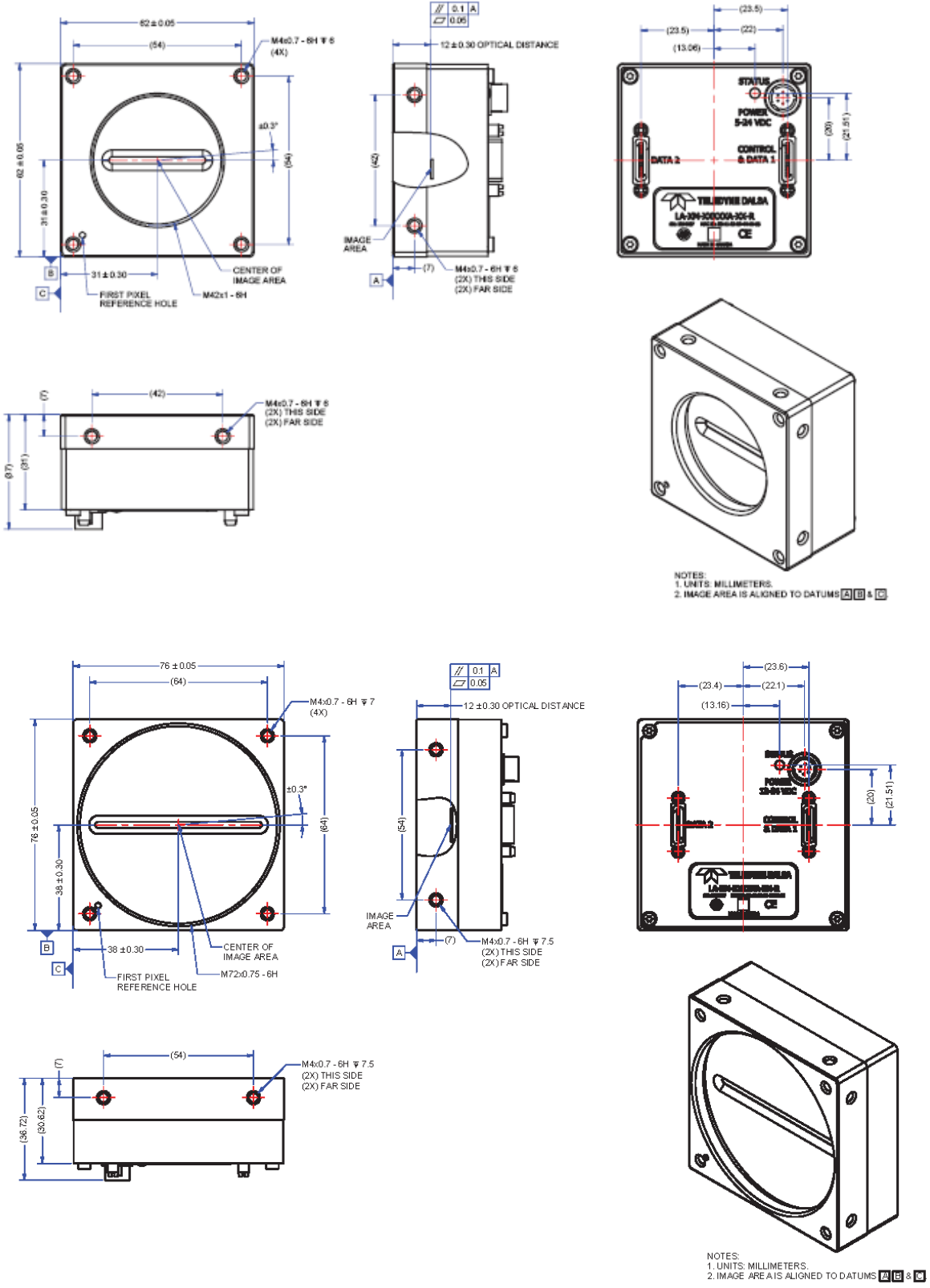

Figure 6: 4k (top) and 8k (bottom) camera mechanicals



# Quick, Simple Steps to Acquire an Image

For users who are familiar with Camera Link cameras, have a basic understanding of their imaging requirements, and who are primarily interested in evaluating the camera, an overview of the steps required to get this camera operational and acquiring images quickly can be found in [Appendix C: Quick Setup and Image Acquisition](#).

## Software and Hardware Setup

### Recommended System Requirements

To achieve best system performance, the following minimum requirements are recommended:

- High bandwidth Camera Link frame grabber. We recommend Teledyne DALSA's Xtium™-CL MX4 frame grabbers. More information can be found [here](#).
- Operating system: Windows XP 32-bit.

---

### Setup Steps: Overview

Take the following steps in order to setup and run your camera system. They are described briefly below and in more detail in the sections that follow.

#### Step 1: Install and Configure Frame Grabber and Software (including GUI)

If your host computer does not have a full Camera Link frame grabber then you will need to install one. Follow the manufacturer's installation instructions.

A GenICam™ compliant XML device description file is embedded within the camera firmware allowing GenICam™ compliant application to know the camera's capabilities immediately after connection. Installing SperaLT gives you access to the CamExpert GUI, a GenICam™ compliant application.

#### Step 2: Connect Camera Link and Power Cables

- Connect the Camera Link cable(s) from the camera to the computer.
- Connect a power cable from the camera to a +12 VDC to +24 VDC power supply.



**WARNING!** Grounding Instructions

Static electricity can damage electronic components. It's critical that you discharge any static electrical charge by touching a grounded surface, such as the metal computer chassis, before handling the camera hardware.



**Note:** the use of cables types and lengths other than those specified may result in increased emission or decreased immunity and performance of the camera.

### **Step 3: Establish communicating with the camera**

Start the GUI and establish communication with the camera. Refer to Step 2: Connect Camera Link and Power Cables for a description on communicating with the camera.

#### **ASCII Commands**

As an alternative to the CamExpert (or equivalent) GUI, you can communicate with this camera using ASCII-based commands. A complete list of the commands can be found in the appendix: ASCII User Command Reference.

### **Step 4: Operate the Camera**

At this point you will be ready to start operating the camera in order to acquire images, set camera functions, and save settings.

---

## **Step 1: Install and configure the frame grabber, and software (including GUI)**

### **Install Frame Grabber**

Install a Full configuration Camera Link frame grabber according to the manufacturer's description.

### **Install Sopera LT and CamExpert GUI**

Communicate with the camera using a Camera Link-compliant interface. We recommend you use CamExpert. CamExpert is the camera interfacing tool supported by the Sopera library and comes bundled with Sopera LT. Using CamExpert is the simplest and quickest way to send commands to and receive information from the camera.

### **Camera Link Environment**

These cameras implement the Camera link specification, which defines the device capabilities.

The Camera link XML device description file is embedded within the camera firmware allowing Camera link-compliant applications to recognize the cameras' capabilities immediately after connection.



## Step 2: Connect Data, Trigger, and Power Cables

Note: the use of cables types and lengths other than those specified may result in increased emission or decreased immunity and performance of the camera.

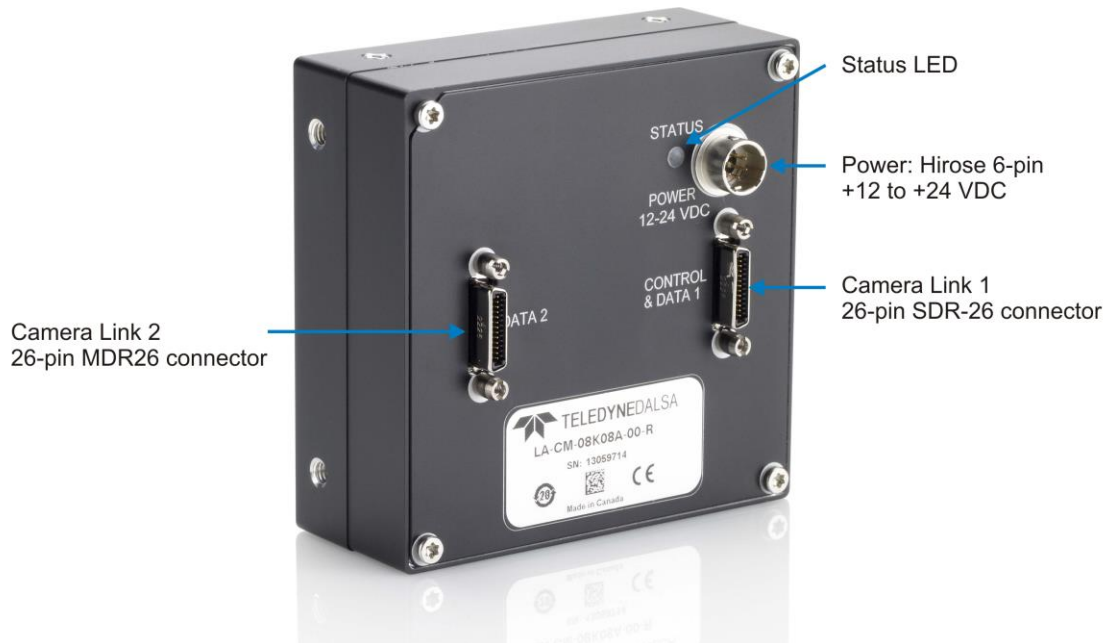

Figure 7: Input and Output, trigger, and Power Connectors



### WARNING! Grounding Instructions

Static electricity can damage electronic components. It's critical that you discharge any static electrical charge by touching a grounded surface, such as the metal computer chassis, before handling the camera hardware.

## Data Connector: Camera Link

The camera uses two Camera Link SDR-26 cables transmitting the Camera Link configurations. The figure below shows the SDR-26 Camera Link Connector and the tables that follow list the Camera Link Base, Medium, Full, and Deca configurations.

For detailed information on Camera Link please refer to the Camera Link Road Map available from the [Knowledge Center](#) on the Teledyne DALSA Web site.

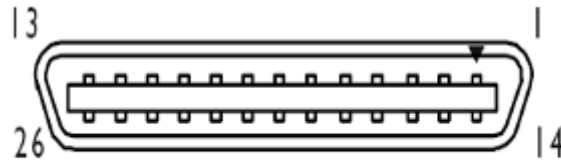

Figure 8. SDR-26 Camera Link Connector

Data 2			Control / Data 1		
Camera Connector	Right Angle Frame Grabber Connector	Channel Link Signal	Camera Connector	Right Angle Frame Grabber Connector	Channel Link Signal
1	1	inner shield	1	1	inner shield
14	14	inner shield	14	14	inner shield
2	25	Y0-	2	25	X0-
15	12	Y0+	15	12	X0+
3	24	Y1-	3	24	X1-
16	11	Y1+	16	11	X1+
4	23	Y2-	4	23	X2-
17	10	Y2+	17	10	X2+
5	22	Yclk-	5	22	Xclk-
18	9	Yclk+	18	9	Xclk+
6	21	Y3-	6	21	X3-
19	8	Y3+	19	8	X3+
7	20	100 ohm	7	20	SerTC+
20	7	terminated	20	7	SerTC-
8	19	Z0-	8	19	SerTFG-
21	6	Z0+	21	6	SerTFG+
9	18	Z1-	9	18	CC1-
22	5	Z1+	22	5	CC1+
10	17	Z2-	10	17	CC2+
23	4	Z2+	23	4	CC2-
11	16	Zclk-	11	16	CC3-
24	3	Zclk+	24	3	CC3+
12	15	Z3-	12	15	CC4+
25	2	Z3+	25	2	CC4-
13	13	inner shield	13	13	inner shield
26	26	inner shield	26	26	inner shield

Note:

\*Exterior Overshield is connected to the shells of the connectors on both ends. Unused pairs should be terminated in 100 ohms at both ends of the cable. Inner shield is connected to signal ground inside camera

## Camera Link Bit Definitions

Signal	Configuration	Remarks
CC1	EXSYNC	Keep this signal in low status when idle. The exposure time must not be greater than the camera's allowance, which, in this case, is 3,000 $\mu$ s.
CC2	Spare	
CC3	Direction	
CC4	Spare	

Table 1: Camera Control Configuration

For additional Camera Link documentation refer to the Teledyne DALSA Web site's [Knowledge Center application notes](#).

## Camera Link Timing Diagrams

RGB 8 bit CL Base, max line rate 10 kHz (8K), 20 KHz (4K) without AOI and 85 MHz CL Clock

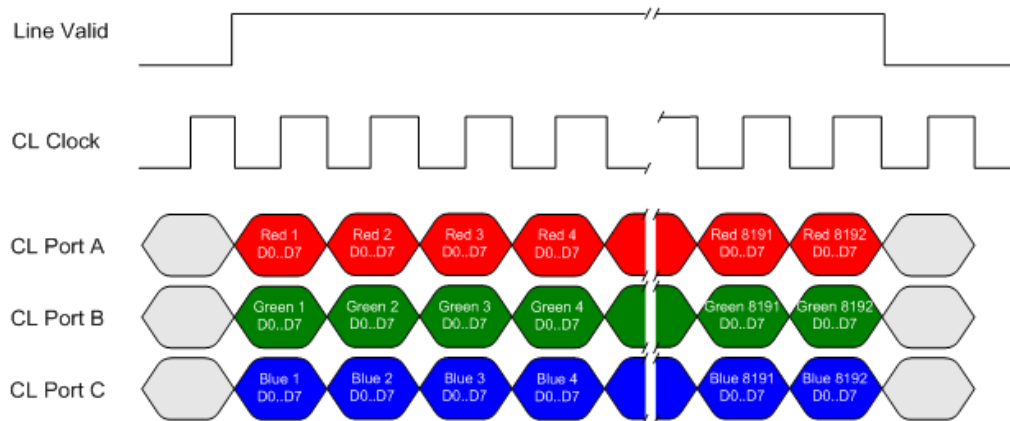

This timing can be used for applications that require line rates only up to 10 kHz and therefore can use Camera Link Base mode with only one cable.

The RGB output format is compatible with the Camera Link specification for Base RGB. Values for red even numbered pixels are interpolated from the neighboring red odd numbered pixels. Values for blue odd numbered pixels are interpolated from the neighboring blue even numbered pixels. Line rates up to 48 kHz can be achieved by using the Area of Interest (AOI) feature; where the smaller the AOI, the greater the potential line rate.

RGB 8 bit CL Medium, max line rate 20 kHz (8K), 40 KHz (4K) without AOI and 85 MHz CL clock

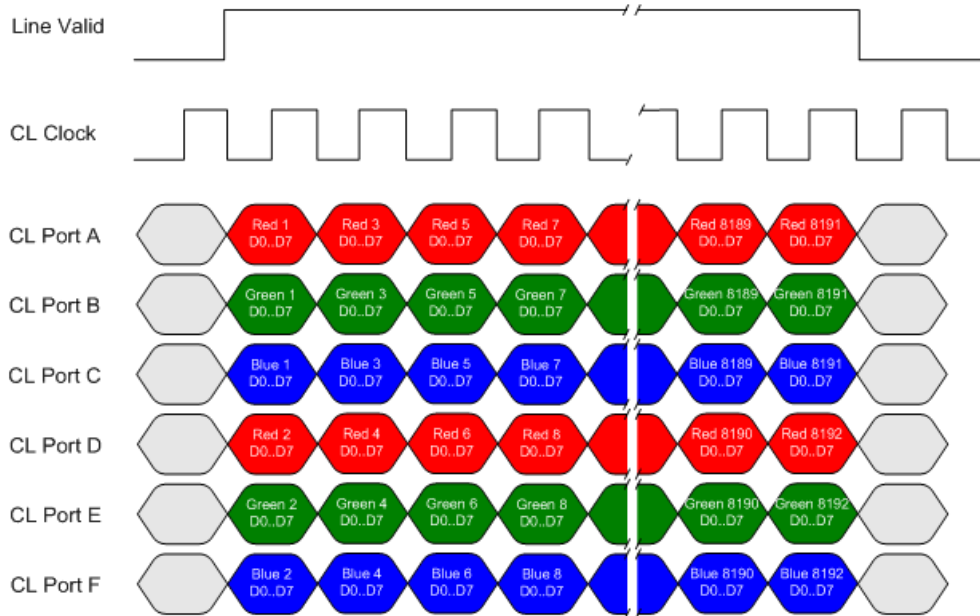

This timing can be used for applications that require line rates up to 20 kHz and therefore must use Camera Link Medium mode and two cables.

The RGB output format is compatible with the Camera Link specification for Medium RGB. Values for red even numbered pixels are interpolated from the neighboring red odd numbered pixels. Values for blue odd numbered pixels are interpolated from the neighboring blue even numbered pixels. Line rates up to 48 kHz can be achieved by using the Area of Interest (AOI) feature; where the smaller the AOI, the greater the potential line rate.



RGB 8 bit CL Full, max line rate 27 kHz (8K), 48 KHz (4K) without AOI and 85 MHz CL clock

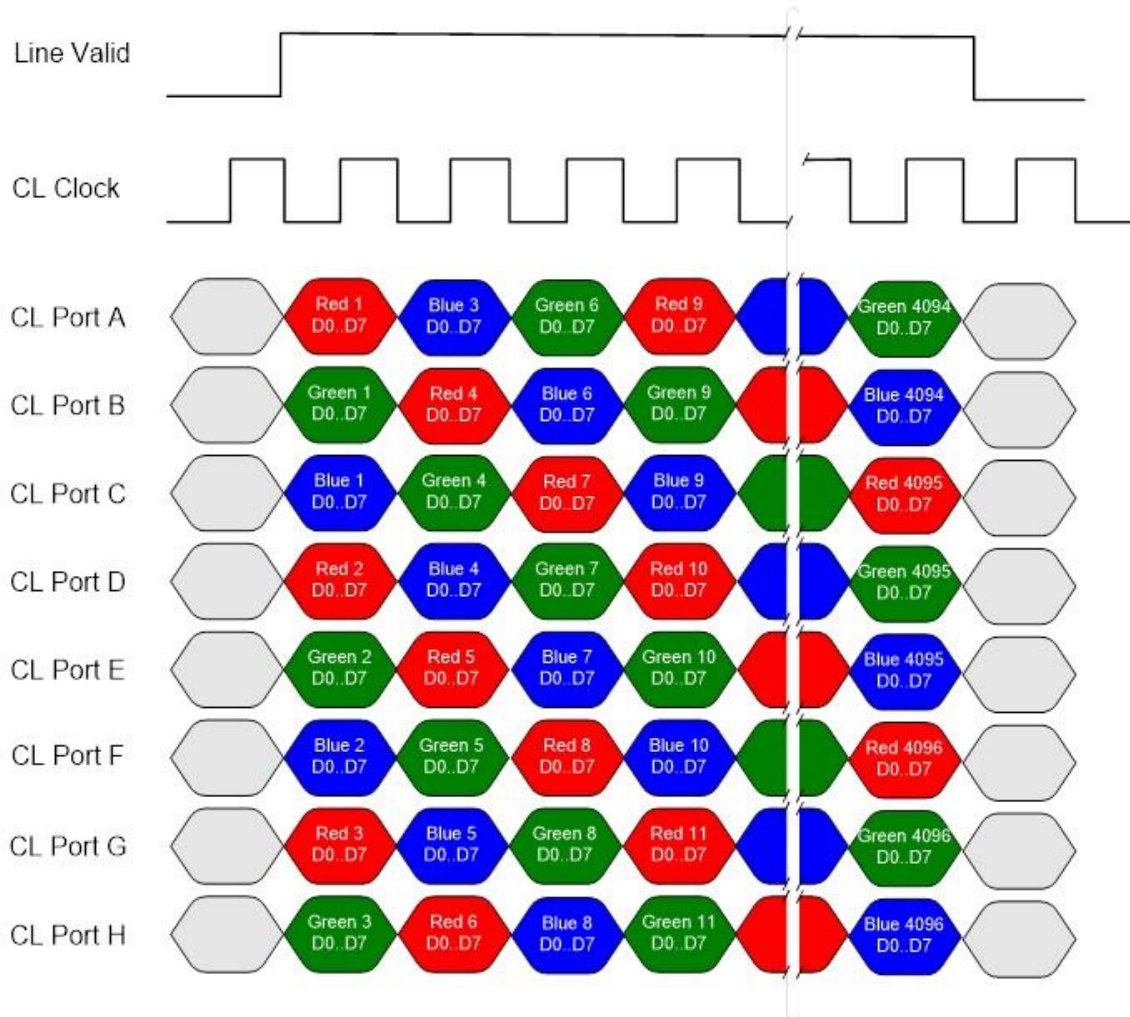

This timing can be used for applications that require line rates up to 27 kHz and therefore must use Camera Link Full mode and two cables.

The RGB output format is compatible with the Camera Link specification for Full RGB. Values for red even numbered pixels are interpolated from the neighboring red odd numbered pixels. Values for blue odd numbered pixels are interpolated from the neighboring blue even numbered pixels. Line rates up to 48 kHz can be achieved by using the Area of Interest (AOI) feature; where the smaller the AOI, the greater the potential line rate.

## RGB 8 bit CL Deca, max line rate 48 kHz without AOI and 85 MHz CL clock

Note: The inserted dummy pixels at the end

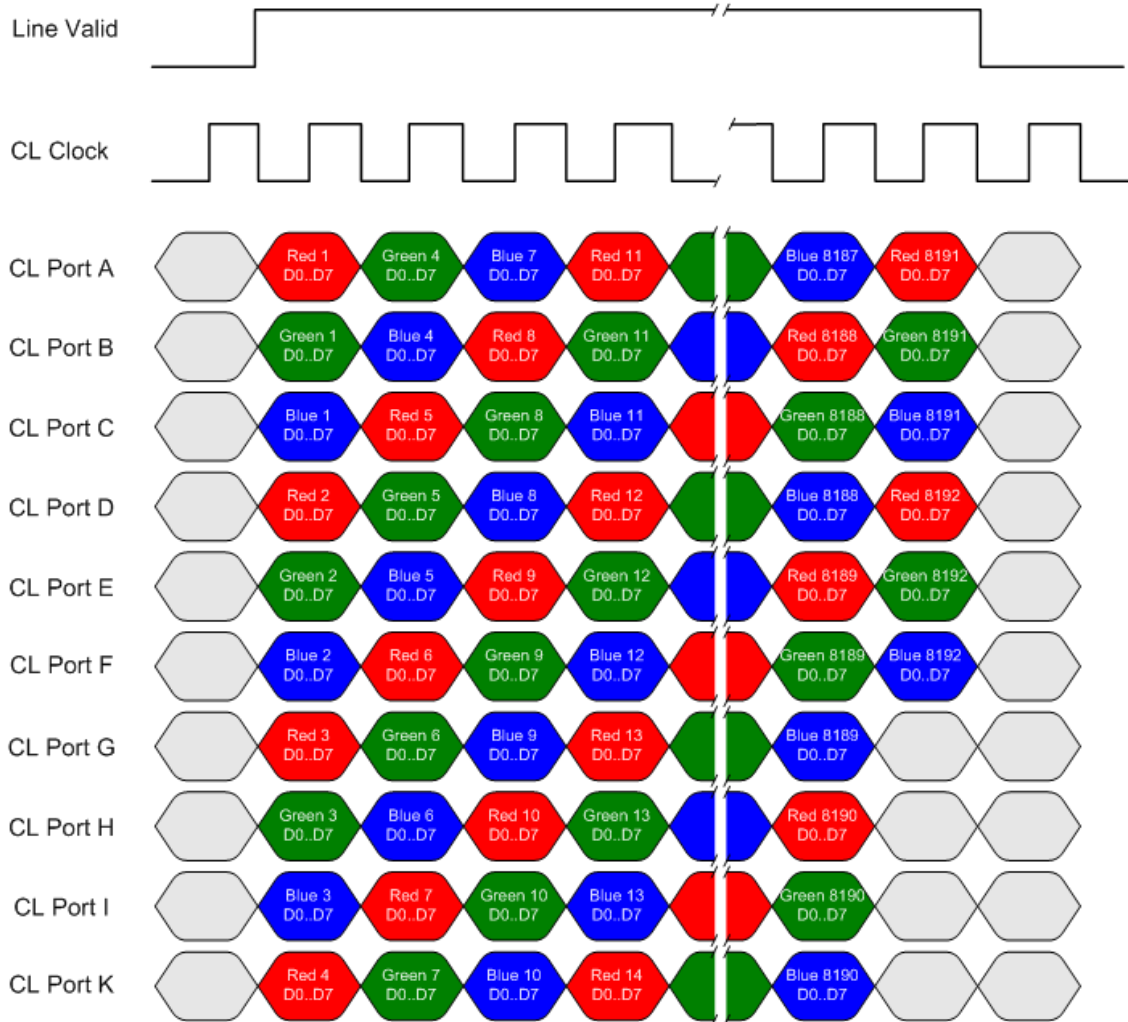

This timing can be used for applications that require line rates up to 48 kHz and therefore must use Camera Link Deca mode and two cables.

The RGB output format is not defined in the Camera Link specification Deca. The RGB format is such that when using a Camera Link frame grabber compatible with the Deca format configured for the mono standard, the R, G and then B pixels will be written sequentially into the frame grabber buffer. This process simplifies the extraction of the RGB data from the frame grabber buffer by the host application. Values for red even numbered pixels are interpolated from the neighboring red odd numbered pixels. Values for blue odd numbered pixels are interpolated from the neighboring blue even numbered pixels.







RGB 12 bit CL Medium, maximum line rate 10 kHz (8K), 20 KHz (4K), no AOI and 85 MHz CL clock

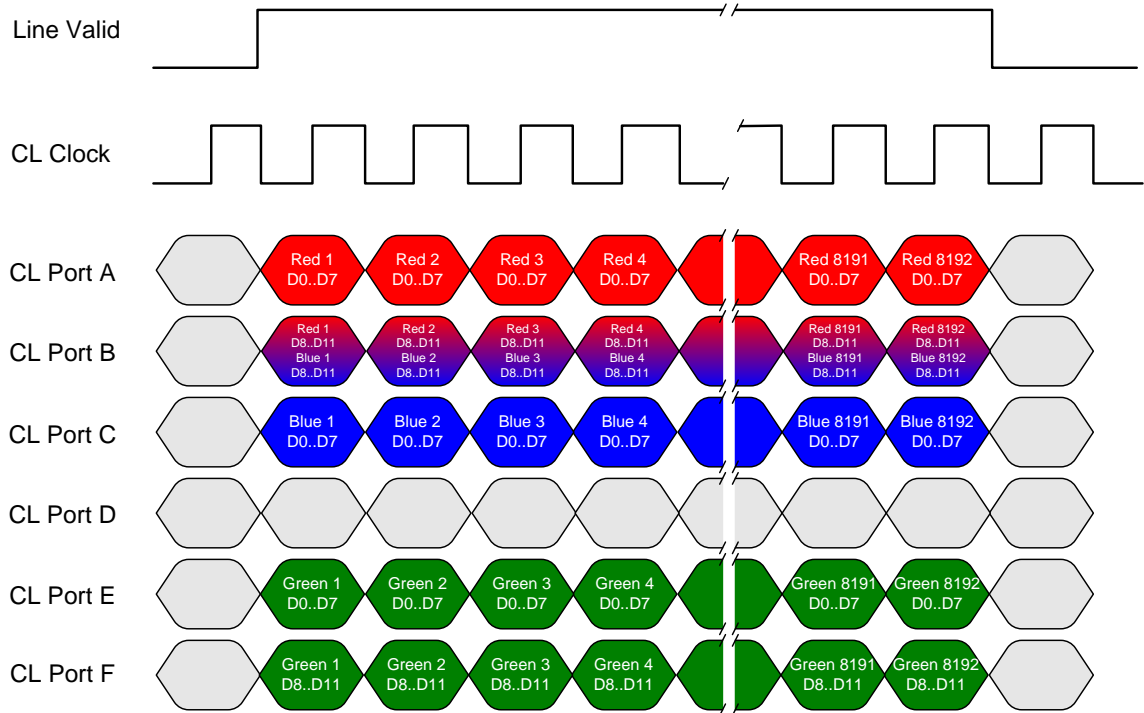

Port B Bit Assignments		Port F Bit Assignments	
D0	Red 8	D0	Green 8
D1	Red 9	D1	Green 9
D2	Red 10	D2	Green 10
D3	Red 11	D3	Green 11
D4	Blue 8	D4	N/A
D5	Blue 9	D5	N/A
D6	Blue 10	D6	N/A
D7	Blue 11	D7	N/A

This timing can be used for applications that require line rates up to 20 kHz and therefore must use Camera Link Medium mode and two cables.

The RGB output format is compatible with the Camera Link specification for Medium RGB. Line rates up to 48 kHz can be achieved by using the Area of Interest (AOI) feature; where the smaller the AOI, the greater the potential line rate.

RGB 12 bit CL Deca, maximum line rate 23 kHz (8K), 46 KHz (4K), no AOI and 85 MHz CL clock

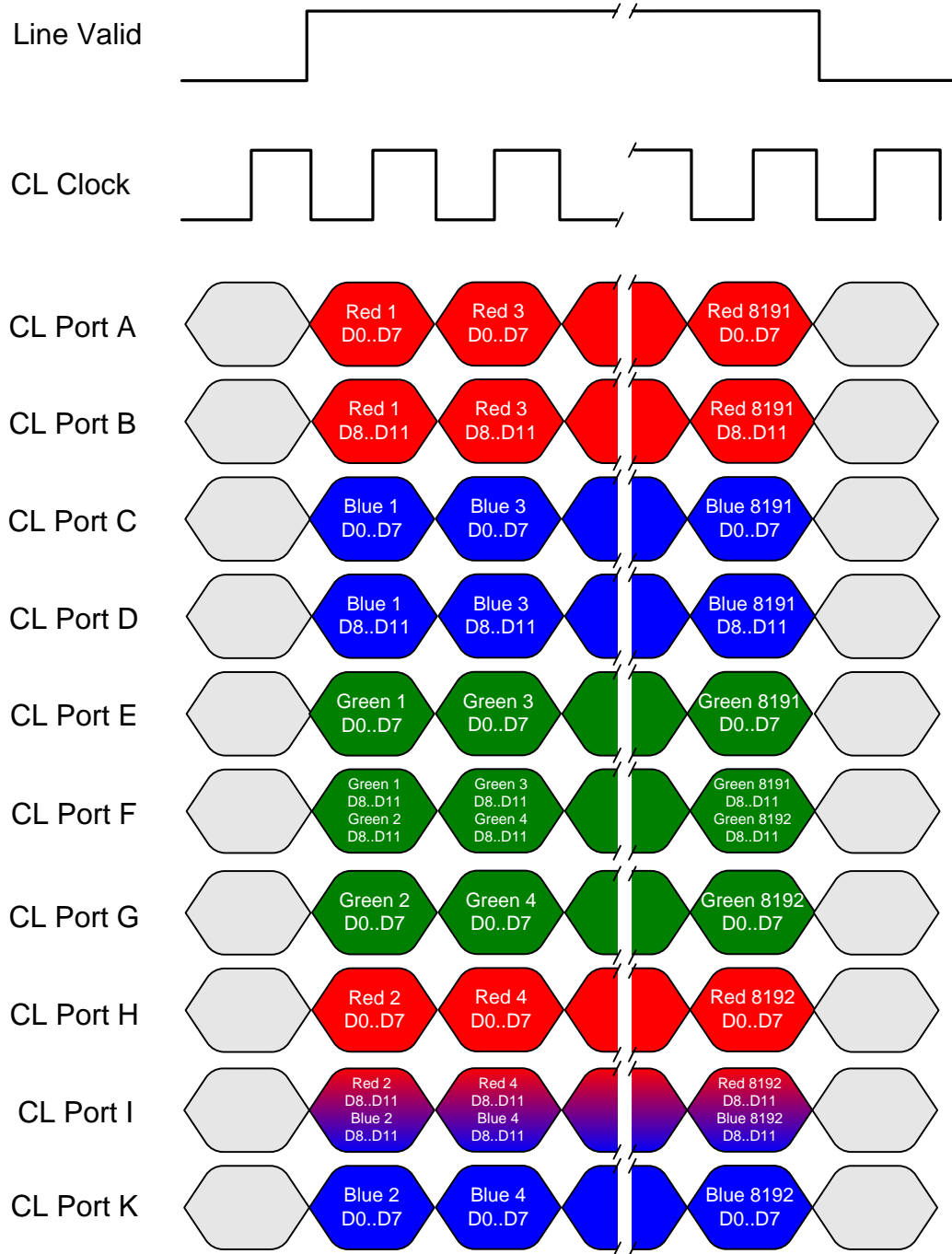

This timing can be used for applications that require line rates up to 23 kHz and therefore must use Camera Link Deca mode and two cables.

The RGB output format is not defined in the Camera Link specification Deca. The RGB format is such that when using a Camera Link frame grabber compatible with the Deca format configured for the mono standard, the R, G and then B pixels will be written

sequentially into the frame grabber buffer. This process simplifies the extraction of the RGB data from the frame grabber buffer by the host application. Line rates up to 48 kHz can be achieved by using the Area of Interest (AOI) feature; where the smaller the AOI, the greater the potential line rate.

---

## AOI Rules

When using the AOI feature, there are specific AOI rules with respect to AOI sizes and boundaries that must be adhered to, see below.

### Custom AOI Rules

- 1) The sensor has pixels 0 to 8191. In RGBG mode, red pixels are 0, 2, 4... Blue pixels are 1, 3, 5...
- 2) Three values (red, blue, green) are output per pixel in RGB mode.
- 3) Two values (red / blue, green) are output per pixel in RGBG mode.
- 4) In RGBG non-mirrored mode, the first pixel of an AOI is always red / green.
- 5) In RGBG mirrored mode, the first pixel of an AOI is always blue / green.
- 6) Whether mirroring is on or off, 0 is the leftmost pixel.
- 7) Whether mirroring is on or off, AOI 1 is readout first.
- 8) In normal mode, AOI 1 is closest to the sensor's left edge.
- 9) In mirror mode, AOI 1 is closest to the sensor's right edge.

### Base, Medium, and Full RGB Modes

- 1) The total number of pixels within each AOI must be a multiple of 8 and must be  $>$  or  $= 40$ .
- 2) In normal mode, the first pixel of each AOI (AOI left edge) must have the location  $8i$ , where  $i = 0, 1, 2, \dots, 1023$  (i.e., 8, 960, and 7680 are allowed, 12 is not allowed).
- 3) In mirror mode, the first pixel of each AOI (AOI right edge) must have the location  $8i + 7$ , where  $i = 0, 1, 2 \dots 1023$  (i.e., 7, 15, and 4095 are allowed, 8 is not allowed).

### DECA RGB8 and DECA RGBG8 Modes

- 1) The total number of pixels within each AOI must be a multiple of 40.
- 2) In normal mode, the first pixel of each AOI (AOI left edge) must have the location  $8i$ , where  $i = 0, 1, 2 \dots 1023$  (i.e., 8, 960, and 7680 are allowed, 12 is not allowed).
- 3) In mirror mode, the first pixel of each AOI (AOI right edge) must have the location  $8i + 7$ , where  $i = 0, 1, 2 \dots 1023$  (i.e., 7, 15, and 8191 are allowed, 8 is not allowed).

### Full Green Only Mode

- 1) The total number of pixels within each AOI must be a multiple of 8 and must be  $>$  or  $= 40$ .
- 2) In normal mode, the first pixel of each AOI (red left edge pixel) must have the location  $8i$ , where  $i = 0, 1, 2 \dots 1023$  (i.e., 0, 8, and 6000 are allowed, 15 is not allowed).

- 3) In mirror mode, the first pixel of each AOI (blue right edge pixel) must have the location  $8i + 7$ , where  $i = 2, 3, 4 \dots 1023$  (i.e., 31 and 8191 are allowed, 8 and 1024 are not allowed).

## Pixel Format Selection

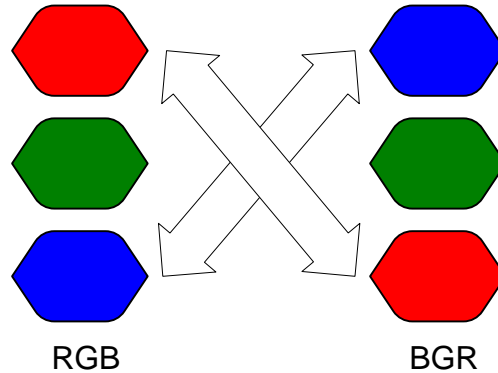

Figure 9. Pixel Format Selection

The output pixel format can be selected between an RGB or BGR output using the spf ASCII command or by using Pixel Format in the GENCP.

The camera link output modes are the same except the red and blue positions are swapped.

## Camera Link cable quality and length

The maximum allowable Camera Link cable length depends on the quality of the cable used and the Camera Link strobe frequency. Cable quality degrades over time as the cable is flexed. In addition, as the Camera Link strobe frequency is increased the maximum allowable cable length will decrease.

The camera is capable of driving cables 10 meters or less in length. We do not guarantee good imaging performance with low quality cables of *any* length. In general, we recommend the use of high quality cables for any cable length.

---

## Input Signals

### Camera Link

The camera accepts control inputs through the Camera Link SDR-26F connector. The camera ships in internal sync, and internally programmed integration.

### EXSYNC (Line Readout Trigger)

Line rate can be set internally using the GenICam features. The external control signal EXSYNC is optional and enabled through the user interface. This camera uses the falling edge of EXSYNC to trigger pixel readout.

The EXSYNC signal tells the camera when to integrate and readout the image. It can be either an internally generated signal by the camera, or it can be supplied externally via the

serial interface. Depending upon the mode of operation the high time of the EXSYNC signal can represent the integration period.

Note: The EXSYNC signal is measured at CC1 and will give a “true” measurement (i.e. within the measurement resolution of 25 ns) even though the camera will only trigger at a maximum of 48 KHz.

## Output Signals

### Camera Link Clocking Signals

These signals indicate when data is valid, allowing you to clock the data from the camera to your acquisition system. These signals are part of the Camera Link configuration and you should refer to the Camera Link Implementation Road Map, available at our [Knowledge Center](#), for the standard location of these signals.

Clocking Signal	Indicates
LVAL (high)	Outputting valid line
DVAL	Not used
STROBE (rising edge)	Valid data
FVAL	Not used

### Power Connector



**WARNING:** It is extremely important that you apply the appropriate voltages to your camera. Incorrect voltages may damage the camera. Input voltage requirement: +12 VDC to +24 VDC, 2 Amps. Before connecting power to the camera, test all power supplies.

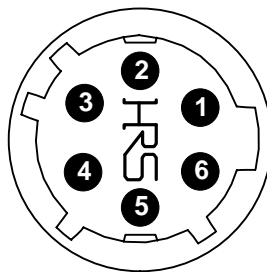

Figure 10: 6-pin Hirose Circular Male Power Plug—Power Connector

Table 2. Power Plug Pinout

Pin	Description	Pin	Description
1	+12 V to +24 V DC	4	GND
2	+12 V to +24 V DC	5	GND
3	+12 V to +24 V DC	6	GND

The camera requires a single voltage input +12 VDC to +24 VDC. The camera meets all performance specifications using standard switching power supplies, although well-regulated linear supplies provide optimum performance.

**WARNING:** When setting up the camera's power supplies follow these guidelines:



- Apply the appropriate voltages.
- Protect the camera with a 2 amp slow-blow fuse between the power supply and the camera.
- Do not use the shield on a multi-conductor cable for ground.
- Keep leads as short as possible in order to reduce voltage drop.
- Use high-quality supplies in order to minimize noise.

Note: If your power supply does not meet these requirements, then the camera performance specifications are not guaranteed.

## Camera Status LED

The camera has one multicolor LED to provide a simple visible indication of camera state. The table below summarizes the operating states of the camera and the corresponding LED states. When more than one condition is active, the LED indicates the condition with the highest priority.

LED State	Definition
LED is off	No power or hardware malfunction
Blinking Green	Powering up or calibrating
Green	Ready
Red	Error. Check the built-in self test (BiST) register for the specific error

---

## Step 3: Establish Communication with the Camera

### Power on the camera

Turn on the camera's power supply. You may have to wait while the camera readies itself for operation. The camera must boot fully before it will be recognized by the GUI—the LED shines green once the camera is ready.

### Connect to the frame grabber

1. Start Sopera CamExpert (or equivalent Camera Link compliant interface) by double clicking the desktop icon created during the software installation.
2. CamExpert will search for installed Sopera devices. In the Devices list area on the left side, the connected frame grabber will be shown.
3. Select the frame grabber device by clicking on the name.

### Connect to the camera

1. Start a new Sopera CamExpert application (or equivalent Camera Link compliant interface) by double clicking the desktop icon created during the software installation.
2. In the Devices list area on the left side, select the COM port below the Camera Link label.



Figure 11. CamExpert Icon, created during software installation

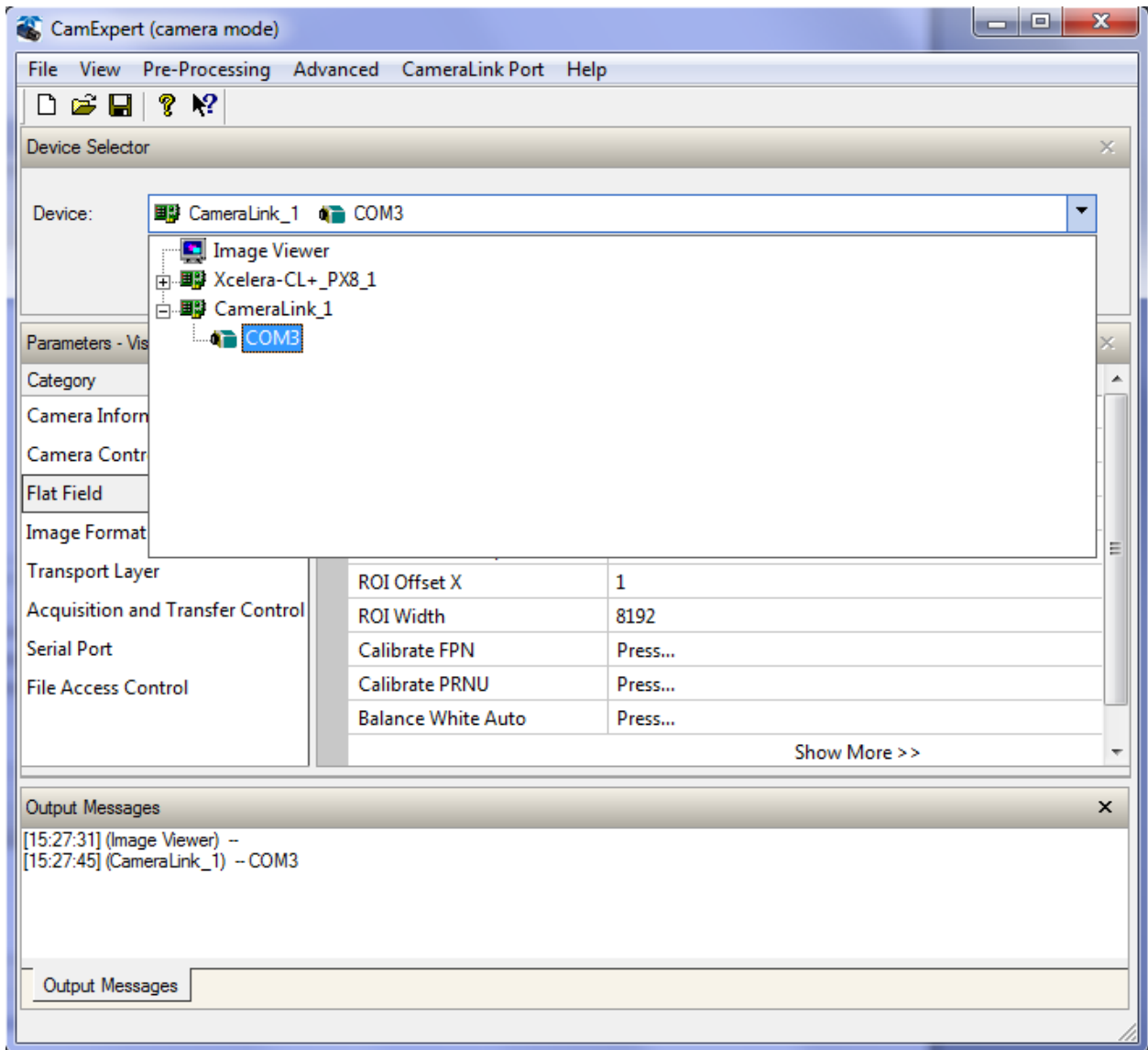

Figure 12. CamExpert GUI showing connected camera

## Check LED Status

If the camera is operating correctly at this point, the diagnostic LED will be solid green.

## Software Interface

All the camera features can be controlled through the CamExpert interface. For example, under the Sensor Control menu in the camera window you can control the line rate and exposure times.

Note: the camera uses two CamExpert windows to send commands and display the results. One window controls the camera and the other is used for image acquisition and display.

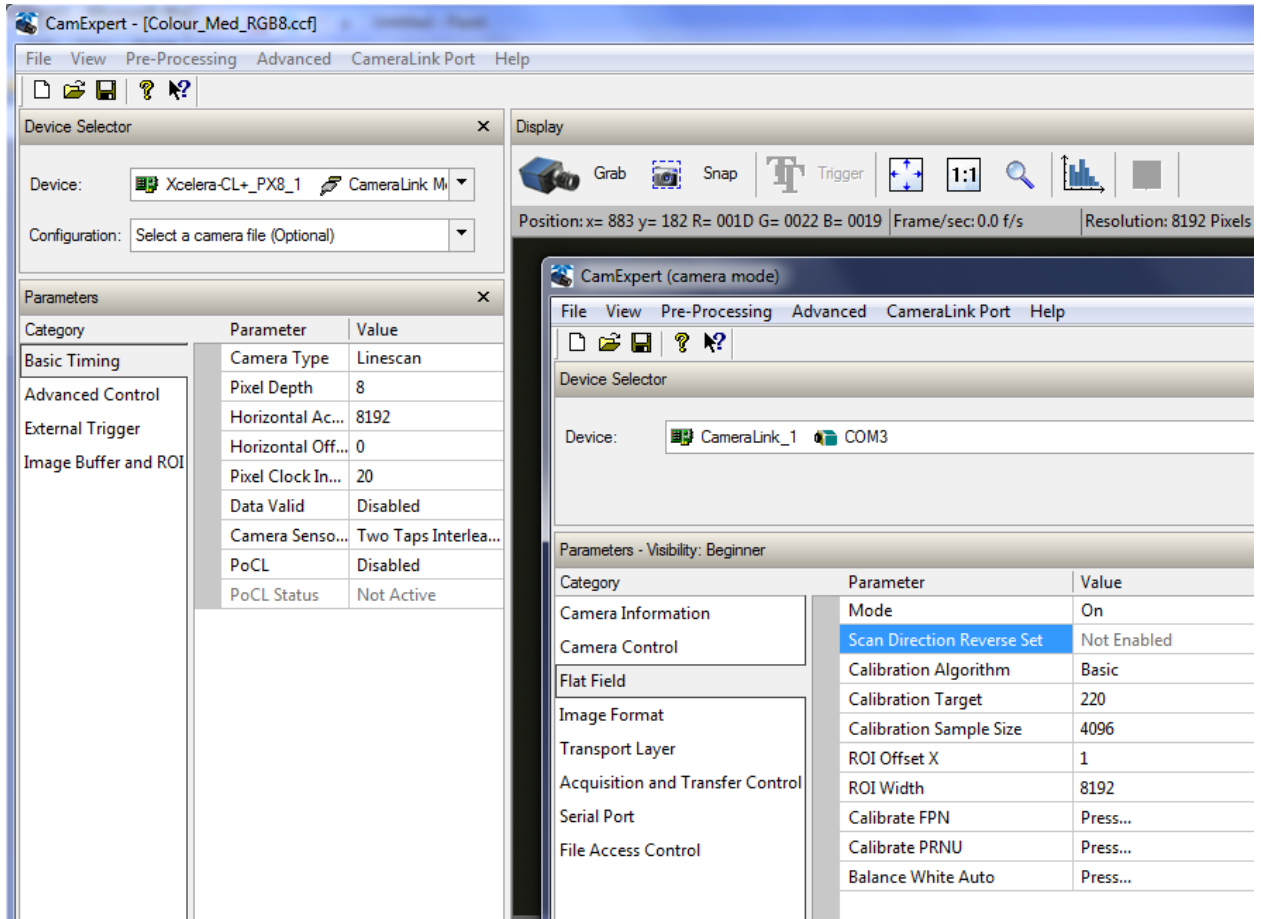

Figure 13. Two CamExpert windows shown. One connected to the frame grabber and one to the camera.

At this point your host and camera system should be setup and you can verify the camera's operation by retrieving a test pattern and setting the camera's trigger and exposure time.



---

## Using Sopera CamExpert with Linea Cameras

CamExpert is the camera interfacing tool supported by the Sopera library. When used with a Teledyne DALSA camera, CamExpert allows a user to test all camera operating modes. Additionally CamExpert saves the camera user settings configuration to the camera or saves multiple configurations as individual camera parameter files on the host system (\*.ccf). CamExpert can also be used to upgrade the camera's software.

An important component of CamExpert is its live acquisition display window which allows immediate verification of timing or control parameters without the need to run a separate acquisition program.

For context sensitive help, click on the  button then click on a camera configuration parameter. A short description of the configuration parameter will be shown in a popup.

Click on the  button to open the help file for more descriptive information on CamExpert.

The central section of CamExpert provides access to the camera features and parameters.  
Note: The availability of the features is dependent on the CamExpert user setting.

# CamExpert Panes

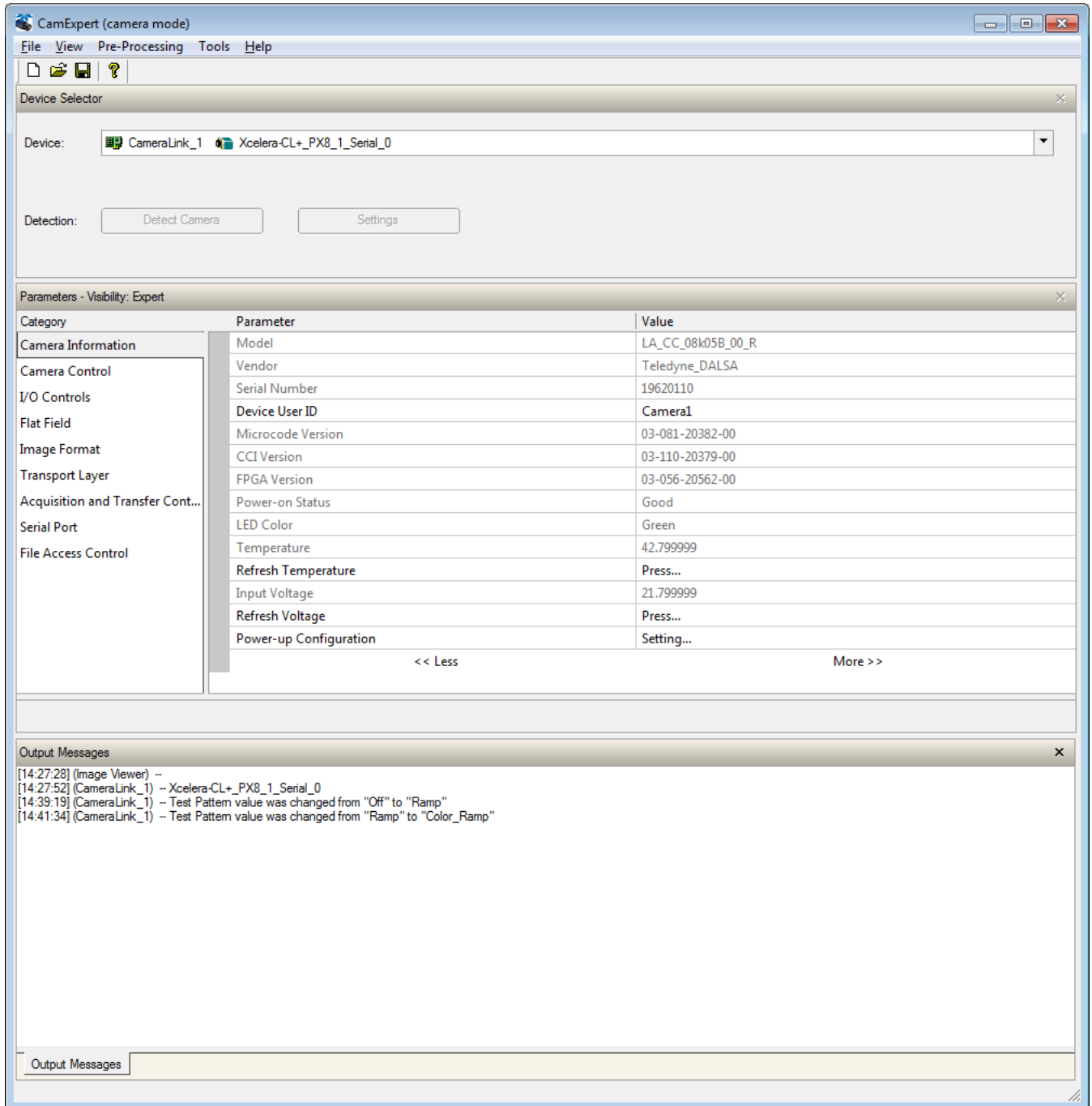

Figure 14. CamExpert's Camera Control Window

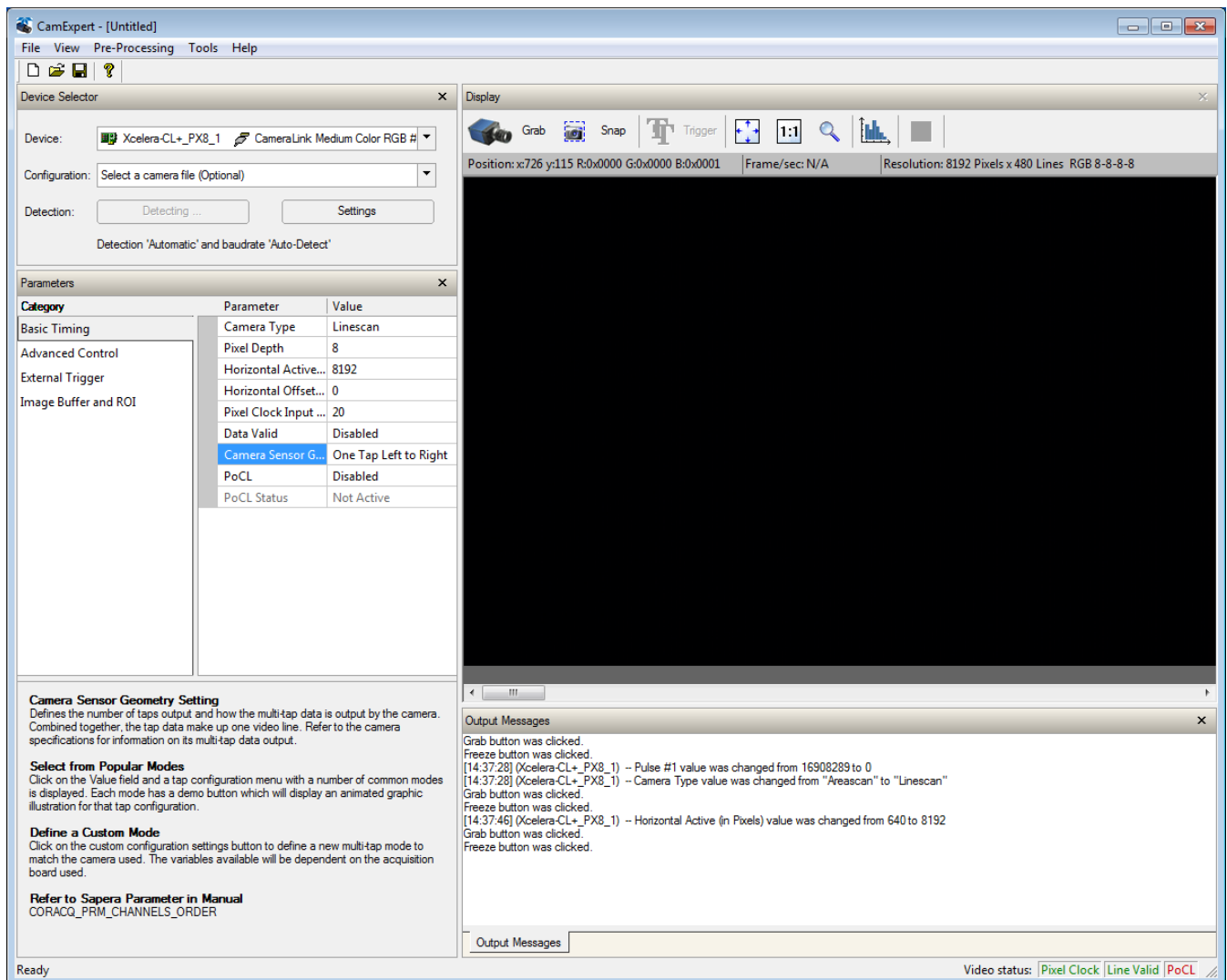



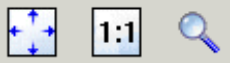



Figure 15. CamExpert's Image Acquisition Window

The CamExpert application uses panes to simplify choosing and configuring camera files or acquisition parameters for the installed device.

- **Device Selector pane:** View and select from any installed Sapera acquisition device. Once a device is selected CamExpert will only present acquisition parameters applicable to that device. Optionally select a camera file included with the Sapera installation or saved by the user.
- **Parameters pane:** Allows viewing or changing all acquisition parameters supported by the acquisition device. CamExpert displays parameters only if those parameters are supported by the installed device. This avoids confusion by eliminating parameter choices when they do not apply to the hardware in use.
- **Display pane:** Provides a live or single frame acquisition display. Frame buffer parameters are shown in an information bar above the image window.
- **Control Buttons:** The Display pane includes CamExpert control buttons. These are:

 <span>Grab</span>	<p><b>Acquisition control button:</b> Click once to start live grab, click again to stop.</p>
---	---

 Freeze	
 Snap	<b>Single frame grab:</b> Click to acquire one frame from device.
 Trigger	<b>Software trigger button:</b> With the I/O control parameters set to Trigger Enabled / Software Trigger type, click to send a single software trigger command.
	<b>CamExpert display controls:</b> (these do not modify the frame buffer data) Stretch image to fit, set image display to original size, or zoom the image to any size and ratio.
	<b>Histogram / Profile tool:</b> Select to view a histogram or line/column profile during live acquisition or in a still image.

- **Output Message pane:** Displays messages from CamExpert or the device driver.

## Review a Test Image

The camera is now ready to retrieve a test pattern. Select **Image Format Control > Test Pattern** and choose one of the following available test images. In the CamExpert window, click the Grab button and then the Freeze button.

0. Off: Sensor Video

1. Grey Ramp

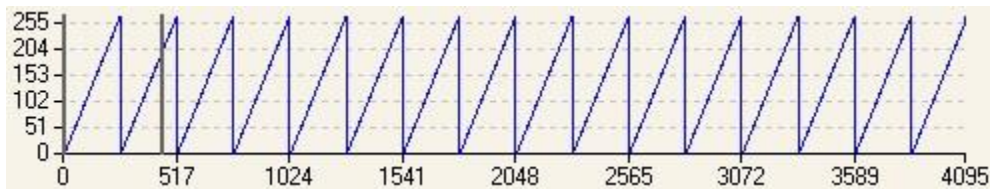

2. Ramp

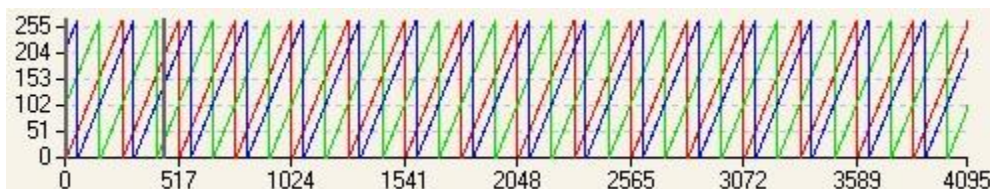

Pixels: {1, 2, 3...}  
 Red Value: {0, 1, 2...}  
 Green Value: {102, 103, 104...}  
 Blue Value: {204, 205, 206...}  
 Values roll over at 255.

At this point you are ready to start operating the camera in order to acquire images, set camera functions, and save settings.

# 4. Camera Operation

## Factory Settings

The camera ships and powers up for the first time with the following factory settings:

- Camera Link Medium, 8 bit pixels, 85 MHz
- Internal trigger, line rate 10 kHz
- Internal exposure control, exposure time 50  $\mu$ s
- Flat field disabled
- User coefficients set to 1x
- Offset 0, System Gain 1x
- Color correction disabled
- Corrected using an 80 mm lens and a magnification of 0.8

## Check Camera and Sensor Information

Camera and sensor information can be retrieved via a controlling application—for example, the CamExpert GUI shown in the following examples. Parameters such as camera model, firmware version, sensor characteristics, etc. are read to uniquely identify the connected device.

The camera information parameters are grouped together as members of the Camera Information set.

Category	Parameter	Value
Camera Information	Model	LA_CC_08k05B_00_R
Camera Control	Vendor	Teledyne_DALSA
I/O Controls	Serial Number	19620110
Flat Field	Device User ID	Camera1
Image Format	Microcode Version	03-081-20382-00
Transport Layer	CCI Version	03-110-20379-00
Acquisition and Transfer Cont...	FPGA Version	03-056-20562-00
Serial Port	Power-on Status	Good
File Access Control	LED Color	Green
	Temperature	51.0
	Refresh Temperature	Press...
	Input Voltage	21.700001
	Refresh Voltage	Press...
	License Key	2F10ADB3-00000000
	Power-up Configuration	Setting...
<< Less		

Figure 16. CamExpert's Camera Information Window

---

## Verify Temperature and Voltage

To determine the voltage and temperature at the camera, use the **Refresh Voltage and Refresh Temperature** features found in the **Camera Information** set.

The temperature returned is the internal temperature in degrees Celsius. For proper operation, this value should not exceed 75 °C. If the camera exceeds the designated temperature it will stop imaging and the LED will turn red. Once you have diagnosed and remedied the issue use the **reset camera** function.

The voltage displayed is the camera's input voltage.

Note: The voltage measurement feature of the camera provides only approximate results (typically within 10% and dependent on the voltage drop in the cable). The measurement should not be used to set the applied voltage to the camera, but only used as a test to isolate gross problems with the supply voltage.

---

## Saving and Restoring Camera Settings

The parameters used to select, load and save user sets are grouped together under the Camera Information set of features. There are 8 user sets available and one factory set.

Camera Information	
Parameter	Choices
User Set Default Selector	Select the camera parameters to load when the camera is reset or powered up as the Factory set, or as User Set 1 to 8.  Selecting the set from the list automatically saves it as the default set.
User Set Selector	Select the Factory or User set to Save or Load. -Factory Set -User Set 1 to 8.
User Set Load	Load the set specified by User Set Selector to the camera and make it the active / current set.
User Set Save	Save the current set as selected user set.

## Description of the Camera Settings

The camera operates in one of three settings:

1. Current session.
2. User setting.
3. Factory setting (read-only).
4. Default setting.

The current settings can be saved (thereby becoming the user setting) using the User Set Save parameter. A previously saved user setting (User Set 1 to 8) or the factory settings can be restored using the User Set Selector and User Set Load parameters.

Either the Factory or one of the User settings can be saved as the Default Setting by selecting the set in the User Set Default Selector. The chosen set automatically saves as the default setting and is the set loaded when the camera is reset or powered up.

The relationship between these three settings is illustrated in Figure 17. Relationship between the Camera Settings:

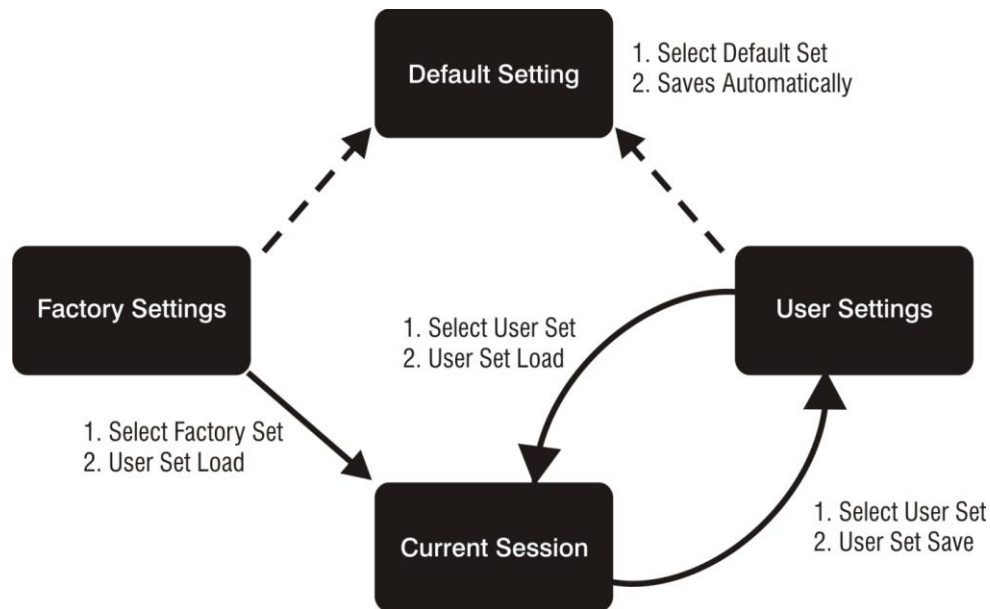

Figure 17. Relationship between the Camera Settings

## Active Settings for Current Session

The active setting for the current session is the set of configurations that are operating while the camera is currently running, including all unsaved changes you have made to the settings before saving them.

These active settings are stored in the camera's *volatile* memory and will be lost and cannot be restored if the camera resets or if the camera is powered down or loses power.

To save these settings for reuse the next time you power up or reset the camera, or to protect against losing them in the case of power loss, you must save the current settings using the **User Set Save** parameter. Once saved, the current settings become the selected **User Set**.

## User Setting

The user setting is the saved set of camera configurations that you can customize, resave, and restore. By default the user settings are shipped with the same settings as the factory set.

The command **User Set Save** saves the current settings to non-volatile memory as a **User Set**. The camera automatically restores the last saved user settings when it powers up.

To restore the last saved user settings, select the **User Set** parameter you want to restore and then select the **User Set Load** parameter.

## Factory Settings

The factory setting is the camera settings that were shipped with the camera and which loaded during the camera's first power-up. To load or restore the original factory settings, at any time, select the **Factory Setting** parameter and then select the **User Set Load** parameter.

Note: By default, the user settings are set to the factory settings.

## Default Setting

Either the Factory or one of the User settings can be used as the Default Setting by selecting the set in the User Set Default Selector. The chosen set automatically becomes the default setting and is the set loaded when the camera is reset or powered up.

---

## Camera Link Configuration

Name	Taps	SPF*	Cables
Base	3	RGB8, BGR8	1
Medium	3	RGB12, BGR12	2
Medium	6	RGB8, BGR8	2
Full	8	RGB8, G8	2
Deca	10	RBG8, BGR8, RGBG8	2
Deca	6	RGB12, BGR12	2

\*Set Pixel Format (number of bits per pixel)

---

## Trigger Modes

The camera's image exposures are initiated by a trigger event. The trigger event is either a programmable internal signal used in free running mode or an external input used for synchronizing exposures to external triggers. These triggering modes are described below.

- **Internal trigger (trigger disabled):** The camera free-running mode has a programmable internal timer for line rate and a programmable exposure period.
- **External trigger (trigger enabled):** Exposures are controlled by an external trigger signal. The external trigger signal is the Camera Link control line CC1.

---

## Exposure Controls

Exposure Control modes define the method and timing of how to control the sensor integration period. The integration period is the amount of time the sensor is exposed to incoming light before the video frame data is transmitted to the controlling computer.

- Exposure control is defined as the start of exposure and exposure duration.
- The start of exposure can be an internal timer signal (free-running mode) or an external trigger signal.
- The exposure duration can be programmable (such as the case of an internal timer) or controlled by the external trigger pulse width.



The camera can grab images in one of three ways. You determine the three imaging modes using a combination of the Exposure Mode parameters (including I/O parameters), Exposure Time and Line Rate parameters.

Description	Line Rate	Exposure Time	Trigger Source (Sync)
Internal line rate and exposure time	Internal, programmable	Internal programmable	Internal
External line rate and exposure time	Controlled by EXSYNC pulse	External (EXSYNC)	External
EXSYNC pulse controlling the line rate. Programmed exposure time.	Controlled by EXSYNC pulse	Internal programmable	External

Figure 18. Exposure controls

The parameters used to select the imaging modes—trigger sources (sync), exposure time, and line rate—are grouped together as the Camera Controls.

Camera Controls	
Parameter	Description
Line Rate (in Hz)	Camera line rate in Hz. Only available when the start line trigger parameter is disabled (Trigger Mode off).
Exposure Mode	Set the operation mode for the camera's exposure. Trigger Width or Timed. Trigger Width is only available when Trigger Mode is enabled.
	Trigger Width Uses the width of the current line trigger signal pulse to control the exposure duration.
	Timed The exposure duration time is set using the Exposure Time feature and the exposure starts with the Line Start event.
Exposure Time	Sets the exposure time (in microseconds). Exposure Mode feature must be set to Timed

## Exposure Modes in Detail

### 1. Internally Programmable Line rate and Internally Programmable Exposure Time (Default)

Line rate is the dominant factor when adjusting the line rate or exposure time. When setting the line rate, exposure time will decrease, if necessary, to accommodate the new line rate. When adjusting the exposure time the range is limited by the line rate.

Note: The camera will not set line periods shorter than the readout period.

GenICam parameters to set:  
I / O Controls > Trigger Mode > Off

### 2. External Line Rate and External Exposure Time (Trigger Width)

In this mode, EXSYNC sets both the line period and the exposure time. The rising edge of EXSYNC marks the beginning of the exposure and the falling edge initiates readout. Note:

$$\text{maximum line rate} = \frac{1}{(\text{exposure time} + \text{low time}^*)}$$

\*Exposure time must be greater than 4  $\mu\text{s}$  and low time greater than 2,000 ns

GenICam parameters to set:

- I / O Controls > Trigger Mode > On
- Sensor Control > Exposure Mode > Trigger Width

**Warning!** When running external line rate and external exposure time, the line rate must not exceed  $1 / (\text{exposure time} + 2,000 \text{ ns})$ . Under these conditions the exposure time will become indeterminate and result in image artifacts. This is not the case when running internal exposure control.

### 3. External Line Rate, Programmable Exposure Time

In this mode, the line rate is set externally with the falling edge of EXSYNC generating the rising edge of a programmable exposure time.

GenICam parameters to set:

- I / O Controls > Trigger Mode > On
- Sensor Control > Exposure Mode > Timed

1. External Trigger Off, Internal Exposure Control  
Free running, not synchronized to an external signal

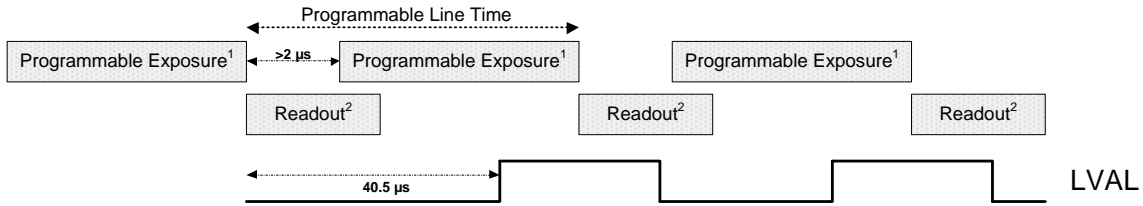

2. External Trigger On, Internal Exposure Control  
CC1 Falling edge triggers start of internal exposure³

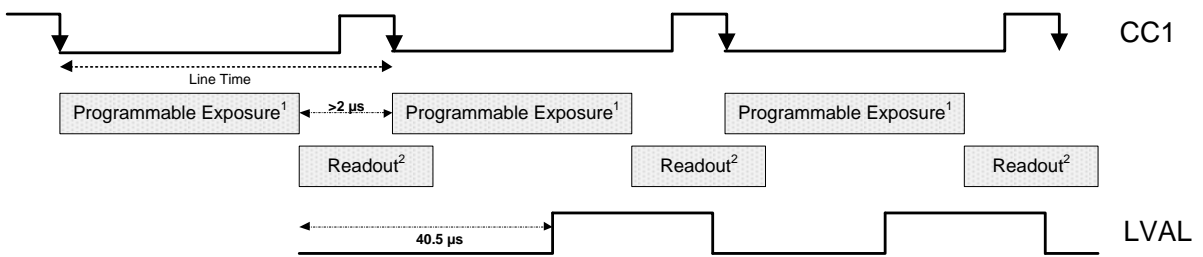

3. External Trigger On, External Exposure Control  
CC1 Falling edge triggers start of exposure  
CC1 high duration sets the exposure time

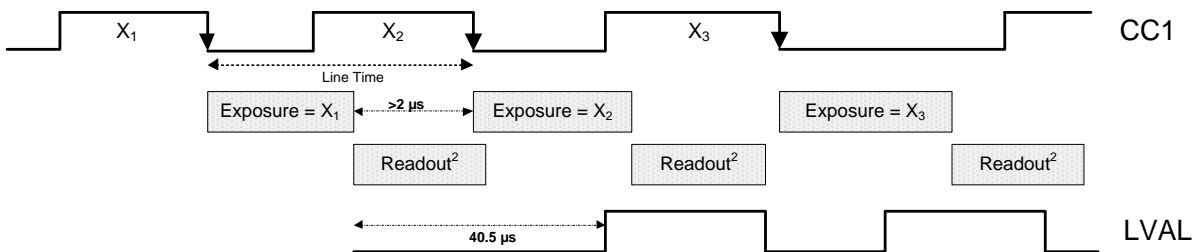

Notes:

1. Exposure time > 7 micro-seconds
2. Readout time = 20.3 micro-seconds
3. One additional falling edge during exposure is latched

Figure 19. Exposure Modes

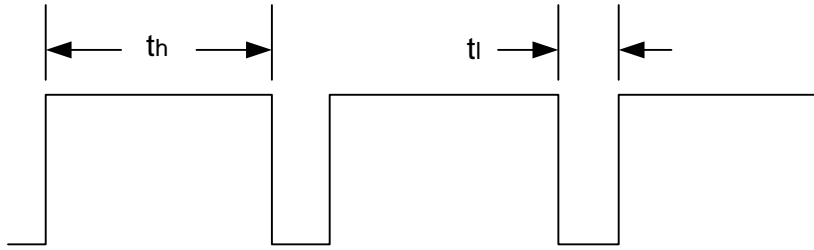

th min	4 μs
tl min	2 μs

Figure 20. External Trigger Minimum High and Low Times

## Set Line Rate

To set the camera’s line rate use the line rate parameter, part of the Sensor Controls set. This feature can only be used when the camera is in Internal mode—that is, when the start line trigger is disabled (Trigger Mode Off).

$$\text{maximum line rate} = \frac{1}{(\text{exposure time} + \text{low time}^*)}$$

\*Exposure time must be greater than 6 μs and low time greater than 2,000 ns

Note: Line rate > (Exposure time + 2,000 ns) will return an error (“Invalid Parameter”) if this condition is not met. You must adjust these two parameters in the correct sequence to maintain this condition.

If the external line rate exceeds 48 kHz the camera will continue to output data at its maximum line rate of 48 kHz. Though no image artifacts associated with over-speed will occur, you may notice that under over-speed conditions the image will appear compressed and the apparent distance travelled will be reduced.

Camera Control	
Parameter	Description
Line Rate	Camera line rate in a range from 1 Hz to 48 KHz.  This feature is only available when the camera is in Internal Mode—line trigger is disabled (Trigger Mode off).

Line Rates		
Camera Link Configuration	8K Maximum	4K Maximum
Base	10 KHz (RGB8)	20 KHz (RGB8)
Medium	20 KHz (RGB8) 23 kHz (RGB12)	40 KHz (RGB8) 46 KHz (RGB12)

Full	27 KHz (RGB8) 48 KHz (G8)	48 KHz (RGB8) 48 KHz (G8)
Deca	48 KHz (RGBG8) 34 KHz (RGB8)	48 KHz (RGBG8) 48 KHz (RGB8)

---

## Set Exposure Time

To set the camera's exposure time, use the **Exposure Time** parameter—a member of the Sensor Controls set. This feature is only available when the **Exposure Mode** parameter is set to **Timed**. The allowable exposure range is from 4  $\mu$ s to 3,000  $\mu$ s, dependent on the value of the internal line rate.

GenICam parameters:

Sensor Controls > Exposure Time (Timed Exposure Mode) > 4  $\mu$ s to 3,000  $\mu$ s.

---

## Control Gain and Black Level

The cameras provide gain and black level adjustments in the digital domain for the CMOS sensor. The gain and black level controls can make small compensations to the acquisition in situations where lighting varies and the lens iris cannot be easily adjusted. The user can evaluate gain and black level by using CamExpert.

The parameters that control gain and black level are grouped together in the Sensor Controls set.

Sensor Controls	
Black Level	Apply a digital addition after an FPN correction: $\pm 1/8$ of the available range of -32 to +31.
Gain	Set the gain as an amplification factor applied to the video signal across all pixels: 1x to 10x.

---

## Set Image Size

To set the height of the image, and therefore the number of lines to scan, use the parameters grouped under the Image Format Control set.

Image Format Control	
Control the size of the transmitted image	
Width	Width of the image.
Height	Height of the image in lines.
Pixel Format	8 bit depth to Camera Link.
Test Image Selector	Select an internal test image: Off Color Ramp Grey Ramp

---

## Set Baud Rate

The baud rate sets the speed (in bits per second—bps) of the serial communication port and is available as part of the Serial Port Control parameters.

Serial Port Control		
Action	Parameter	Options
Control the baud rate used by the camera's serial port	Baud Rate	9600 (factory default) 19200 57600 115200 230400 460800  Note: During connection CamExpert automatically sets the camera to maximum allowable baud.
Number of bits per character used in the serial port	Data Size	8
Parity of the serial port	Parity	None
Number of stop bits per character used in the serial port	Number of Stop Bits	1

---

## Pixel Format

Use the Pixel Format feature, found in the **Image Format Control** set, to select the format of the pixel to use during image acquisition.

Image Format Control	
Parameter	Description
Pixel Format	RGB8 / RGB12 / RGBG8 / G8 / BGR8 / BGR12

---

## Camera Direction Control

Found in the **I / O Control** > **Direction Control** set of features.

Direction Control	
Parameter	Description
Sensor Scan Direction	This command lets you select the <b>Internal</b> or <b>external direction control</b> . Use this feature to accommodate object direction change on a web and to mount the camera "upside down."
Scan Direction	Read the current direction.

---

## Pixel Readout Direction (Mirroring Mode)

Set the tap readout from left to right or from right to left. This feature is especially useful if you want to mount the camera "upside down."

Image Format Control	
Parameter	Description
ReverseX	Off: All pixels are read out from left to right. On: All pixels are read out from right to left.

---

## Resetting the Camera

The feature **Camera Reset**, part of the **Transport Layer** set, resets the camera. The camera resets with the default settings, including a baud rate of 9600.

Camera Information	
Parameter	Description
Camera Reset	Resets the camera and puts in the default settings, including a 9600 baud rate.

# Calibrating the Camera

**Important Note:** to ensure best results, the conditions under which you calibrate the camera (e.g. temperature and illumination) should be as close to the actual operating conditions as possible.

Category	Parameter	Value
Camera Information	Mode	On
Camera Control	Scan Direction Reverse Set	Not Enabled
Flat Field	Calibration Algorithm	Basic
Image Format	Calibration Target	200
Transport Layer	Calibration Sample Size	4096
Acquisition and Transfer Control	ROI Offset X	1
Serial Port	ROI Width	8192
File Access Control	Calibrate FPN	Press...
	Calibrate PRNU	Press...
	Balance White Auto	Press...

Figure 21: Flat Field Calibration in CamExpert

## Calibration Overview

The following diagram and accompanying description explain the camera's signal processing chain. Each element shown, with the exception of color interpolation, is user programmable.

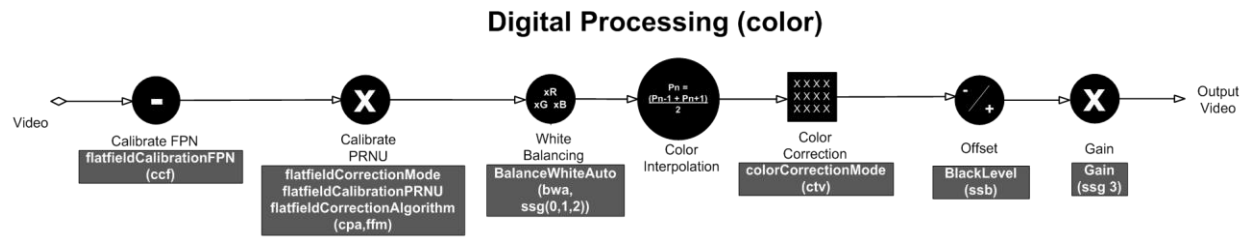

Figure 22: Camera Calibration Process.

### Digital Processing

1. Fixed pattern noise (FPN) calibration is used to subtract any residual dark level that may occur in the application.
2. Photo response non uniformity (PRNU) calibration is used to correct for variations in the illumination intensity and / or lens vignetting. When performed, this calibration will cause the camera to have a flat response to a white target in the field of view. The output target value for PRNU calibration can be set by the user.
3. The white balancing gains are used to set the red, green and blue response to equal values with a white target in the field of view. The white balance gains can be individually set by the user, but will be overridden by the camera when the camera performs PRNU calibration or white balancing commands.
4. The sensor has 4K red and 4k blue alternating pixels. To create 8K red and 8k blue pixels, the blue pixels located at the red position are determined by averaging the



two adjacent blue pixels. The same process is used for the red pixels. This is the only interpolation algorithm provided by the camera.

5. Color correction is available for those users that need to compensate for the spectral transmission characteristics of the sensors color filters and the customers light source. This can be achieved by imaging a MacBeth Chart© illuminated by the application's light source and processing the image using a color correction demonstration tool provided as part of Teledyne DALSA's Sapera Processing software. This tool will generate the desired color correction file that can be downloaded to the camera.
  - Note: Prior to imaging the MacBeth Chart©, the camera should have been calibrated with a white reference in place of the MacBeth Chart© and color correction must be turned off. The calibration process will ensure the camera output is uniform and white balanced.
6. The introduction of offsets has limited value in color applications as it will cause color distortion. However, the camera has the ability to add either a positive or negative offset as required by a specific application. This offset can be useful when trying to measure dark noise where black level clipping will cause an error in the result.
7. A single overall system gain is applied equally to all three colors. It will therefore not cause color distortion when changed.
8. A factory setting for white LED color correction can be applied, if needed.

## Calibration

The goal of calibration is to produce a uniform, white balanced and, if required, color corrected image at the desired level out of the camera when it is imaging a uniform white object, using the optical setup of the user's application.

The user should configure the camera to use the EXSYNC and exposure timing they desire plus adjust the light level for normal operation. The lens should be at the desired magnification, aperture and be in focus. As the white reference located at the object plane will be in focus, any features on its surface (e.g. dust, scratches) will end up in the calibration profile of the camera. To avoid this, use a clean white plastic or ceramic material, not paper. Ideally, the white object should move during the calibration process as the averaging process of the camera will diminish the effects on any small variation in the white reference.

The user may wish to start the calibration process by evaluating the characteristics of their setup with no calibration enabled. This can be readily achieved by disabling FPN, PRNU & color correction coefficients, setting white balance red, green and blue gains to one, and the system gain to one.

Begin by adjusting the system gain until the peak intensity of the three colors is at the desired DN level. You may want to use the white balance gains to adjust the peak of each color to be a similar DN value, but this is not necessary. Before proceeding any further, it is desirable to complete an FPN calibration. This is best performed using a lens cap to ensure no light gets into the camera. Once complete, a PRNU calibration can be performed using a target value you want all the pixels to achieve. This target value can be higher or lower than the peak values you observed while initially setting up the camera. Once PRNU calibration is complete, it will take several seconds, all three colors should be at the target value, white balance gains will have been adjusted to suit the cameras optimum setup for a balanced white output, and the correction coefficient will be enabled. The system gain will remain as

originally set. The coefficient and gain parameters, timing and control configuration etc can be stored in any one of eight user sets and automatically retrieved at power up or by user selection. If a color correction matrix is desired, the user can download and save a color correction file derived from the process described above. Note: For the color correction to be affective, the camera should have a white balanced output when color correction is off.

## 1. Flat Field

This Flat Field set contains a number of features that are used to correct image distortion due to lens vignetting and uneven illumination. .

Note:

1. Flat field coefficients consist of an offset and gain for each pixel.
2. These are the first user corrections applied to the image.
3. The flat field coefficients are saved and loaded with the user set.

Parameter	Description
flatfieldCorrectionMode	Off – Flat field correction coefficients are not applied. On – Flat field correction coefficients are applied. Initialize – Sending this value will reset all current coefficients (offsets to 0 and flat field gains to 1x).
flatfieldCorrectionAlgorithm	Basic – Direct calculation of coefficients based on current average line values and target. LowPass – A low pass filter is first applied to the current average line values before calculating the coefficients. Use this algorithm if the calibration target is not uniform white or it is not possible to defocus the image. Because of the low pass filter this algorithm is not able to correct pixel-to-pixel variations and so it is preferable to use the “Basic” algorithm if possible.
flatfieldCalibrationTarget	After calibration all pixels will be scaled to output this level Range: 8 bit, 0 to 255 DN
flatfieldCalibrationSampleSize	Number of lines to average when calibrating 2048 or 4096
flatfieldCalibrationROIOffsetX	Together with “flatfieldCalibrationROIWidth” specifies the range of pixels to be calibrated. Pixel coefficients outside this range are not changed. It is possible to calibrate different regions sequentially.
flatfieldCalibrationROIWidth	Together with “flatfieldCalibrationROIOffset” specifies the range of pixels to be calibrated. Pixel coefficients outside this range are not changed. It is possible to calibrate different regions sequentially.
flatfieldCalibrationFPN	This feature may not be of use to many users as the camera already subtracts true “dark current”, but it may be useful for some to provide a per pixel offset correction. Range 0 to 31 DN, 8 bit Default value is 0 DN for each pixel
flatfieldCalibrationPRNU	Use “flatfieldCorrectionAlgorithm” to calculate the per pixel gain to achieve the specified target output. Max 15.9998x Default 1x

## 2. Contrast Enhancement

The offset and gain features can be used to maximize the use of the output dynamic range. Typical use is to subtract the minimum pixel value expected and then gain up to the maximum pixel value to approach full scale. This process may be useful for applications that process the RGB colors individually.

### Offset

1. Single value added to each pixel
2. Range -32 to +31 DN
3. Positive values may be used to measure dark noise

### Gain

1. Floating point digital multiplier applied to each pixel
2. Range 1x to 10x

## White Balance over ROI

Use the Balance White Auto command to predetermine a region of the image that is known to be white and to perform a white balance for the whole image based on this region.

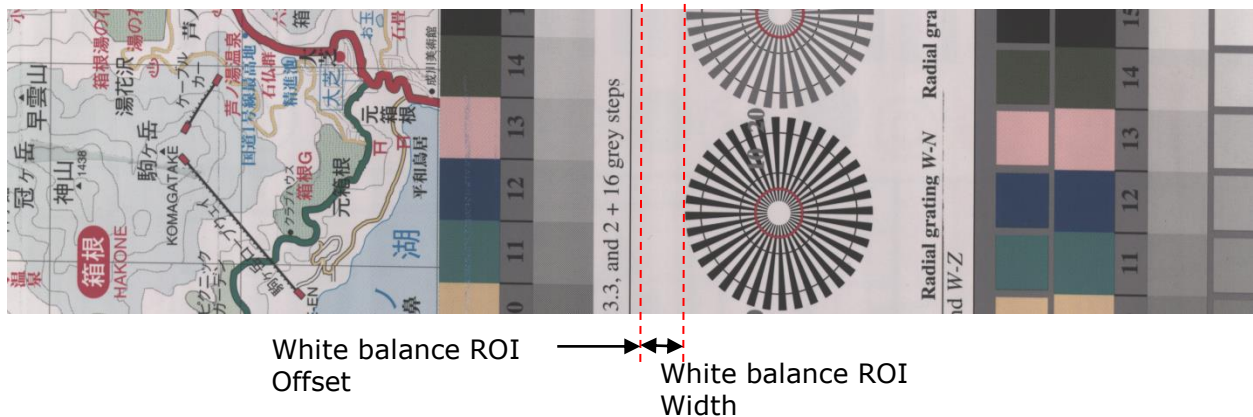

Figure 23: White Balance Over ROI

# Appendix A: GenICam Commands

This appendix lists the available GenICam camera features. Access these features using the CamExpert interface.

Features listed in the description table but tagged as *Invisible* are typically reserved for Teledyne DALSA Support or third party software usage, and not typically required by end user applications.

A note on the CamExpert examples shown here: The examples shown for illustrative purposes and may not entirely reflect the features and parameters available from the camera model used in your application.

## Camera Information Category

Camera information can be retrieved via a controlling application. Parameters such as camera model, firmware version, etc. are read to uniquely identify the connected device. These features are typically read-only.

The Camera Information Category groups information specific to the individual camera. In this category the number of features shown is identical whether the view is Beginner, Expert, or Guru.

Features listed in the description table but tagged as *Invisible* are usually for Teledyne DALSA or third party software usage—not typically needed by end user applications.

Category	Parameter	Value
Camera Information	Model	LA_CC_08k05B_00_R
Camera Control	Vendor	Teledyne_DALSA
I/O Controls	Serial Number	19620110
Flat Field	Device User ID	Camera1
Image Format	Microcode Version	03-081-20382-00
Transport Layer	CCI Version	03-110-20379-00
Acquisition and Transfer Cont...	FPGA Version	03-056-20562-00
Serial Port	Power-on Status	Good
File Access Control	LED Color	Green
	Temperature	51.0
	Refresh Temperature	Press...
	Input Voltage	21.700001
	Refresh Voltage	Press...
	License Key	2F10ADB3-00000000
	Power-up Configuration	Setting...
	<< Less	

## Camera Information Feature Descriptions

The following table describes these parameters along with their view attributes and in which version of the device the feature was introduced. Additionally the Device Version column will indicate which parameter is a member of the DALSA Features Naming Convention (using the tag **DFNC**), versus the GenICam Standard Features Naming Convention (SFNC not shown).

The Device Version number represents the camera software functional group, not a firmware revision number.

Display Name	Feature	Description	Device Version & View
Vendor Name	DeviceVendorName	Displays the device vendor name. (RO)	1.00 Beginner
Model Name	DeviceModelName	Displays the device model name. (RO)	1.00 Beginner
Device Version	DeviceVersion	Displays the device version. This tag will also highlight if the firmware is a beta or custom design. (RO)	1.00 Beginner
Manufacturer Info	DeviceManufacturerInfo	This feature provides extended manufacturer information about the device. (RO)	1.00 Beginner
Firmware Version	DeviceFirmwareVersion	Displays the currently loaded firmware version number. Firmware files have a unique number and have the .cbf file extension. (RO)	1.00 Beginner
Serial Number	DeviceID	Displays the device's factory set camera serial number. (RO)	1.00 Beginner
Device User ID	DeviceUserID	Feature to store user-programmable identifier of up to 15 characters. The default factory setting is the camera serial number. (RW)	1.00 Beginner
Power-up Configuration Selector	UserSetDefaultSelector	Selects the camera configuration set to load and make active on camera power-up or reset. The camera configuration sets are stored in camera non-volatile memory. (RW)	1.00 Beginner
Factory Setting	Default	Load factory default feature settings	
UserSet1	UserSet1	Select the user defined configuration UserSet 1 as the Power-up Configuration.	
UserSet2	UserSet2	Select the user defined configuration UserSet 2 as the Power-up Configuration	
UserSet3	UserSet3	Select the user defined configuration UserSet 3 as the Power-up Configuration	
UserSet4	UserSet4	Select the user defined configuration UserSet 4 as the Power-up Configuration.	
UserSet5	UserSet5	Select the user defined configuration UserSet 5 as the Power-up Configuration.	
UserSet6	UserSet6	Select the user defined configuration UserSet 6 as the Power-up Configuration.	
UserSet7	UserSet7	Select the user defined configuration UserSet 7 as the Power-up Configuration.	
UserSet8	UserSet8	Select the user defined configuration UserSet 8 as the Power-up Configuration.	
User Set Selector	UserSetSelector	Selects the camera configuration set to load feature settings from or save current feature settings to. The Factory set contains default camera feature settings. (RW)	1.00 Beginner
Factory Setting	Default	Select the default camera feature settings saved by the factory	
UserSet 1	UserSet1	Select the User-defined Configuration space UserSet1 to save to or load from features settings previously saved by the user.	

UserSet 2	UserSet2	Select the User-defined Configuration space UserSet2 to save to or load from features settings previously saved by the user.	
UserSet3	UserSet3	Select the User-defined Configuration space UserSet3 to save to or load from features settings previously saved by the user.	
UserSet4	UserSet4	Select the User-defined Configuration space UserSet4 to save to or load from features settings previously saved by the user.	
UserSet5	UserSet5	Select the User-defined Configuration space UserSet5 to save to or load from features settings previously saved by the user.	
UserSet6	UserSet6	Select the User-defined Configuration space UserSet6 to save to or load from features settings previously saved by the user.	
UserSet7	UserSet7	Select the User-defined Configuration space UserSet7 to save to or load from features settings previously saved by the user.	
UserSet8	UserSet8	Select the User-defined Configuration space UserSet8 to save to or load from features settings previously saved by the user.	
Power-on User Set	UserSetDefaultSelector	Allows the user to select between the factory set and 1 to 8 user sets to be loaded at power up	1.00 Beginner
Current User Set	UserSetSelector	Points to which user set (1-8) or factory set that is loaded or saved when the UserSetLoad or UserSetSave command is used	1.00 Beginner
Load Configuration	UserSetLoad	Loads the camera configuration set specified by the User Set Selector feature, to the camera and makes it active. (W)	1.00 Beginner
Save Configuration	UserSetSave	Saves the current camera configuration to the user set specified by the User Set Selector feature. The user sets are located on the camera in non-volatile memory. (W)	1.00 Beginner
Device Built-In Self-Test Status	deviceBISTStatus	Determine the status of the device using the 'Built-In Self-Test'. Possible return values are device-specific. (RO)	1.00 DFNC Beginner
LED Color	deviceLEDColorControl	Displays the status of the LED on the back of the camera. (RO)	1.00 DFNC Beginner
Temperature	DeviceTemperature	Displays the internal operating temperature of the camera. (RO)	1.00 DFNC Beginner
Refresh Temperature	refreshTemperature	Press to display the current internal operating temperature of the camera.	1.00 DFNC Beginner
Input Voltage	deviceInputVoltage	Displays the input voltage to the camera at the power connector (RO)	1.00 DFNC Beginner
Refresh Voltage	refreshVoltage	Press to display the current input voltage of the camera at the power connector	1.00 DFNC Beginner
License Key	securityUpgrade		1.00 DFNC Guru

## Camera Configuration Selection Dialog

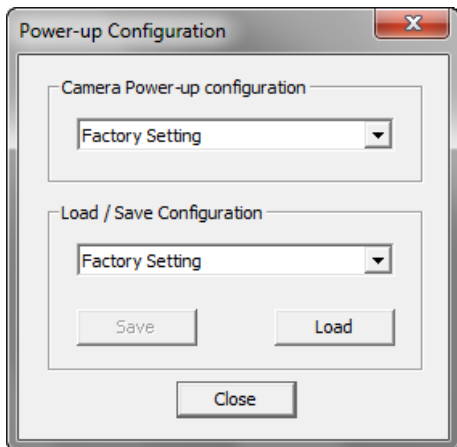

CamExpert provides a dialog box which combines the features to select the camera power up state and for the user to save or load a camera state from Genie memory.

### Camera Power-up Configuration

The first drop list selects the camera configuration state to load on power-up (see feature *UserSetDefaultSelector*). The user chooses from one factory data set or one of two possible user saved states.

### User Set Configuration Management

The second drop list allows the user to change the camera configuration after a power-up (see feature *UserSetSelector*). To reset the camera to the factory configuration, select *Factory Setting* and click Load. To save a current camera configuration, select User Set 1 to 8 and click Save. Select a saved user set and click Load to restore a saved configuration.

---

## Camera Control Category

The camera controls, as shown by CamExpert, group sensor specific parameters. This group includes controls for line rate, exposure time, scan direction, and gain. Parameters in gray are read only, either always or due to another parameter being disabled. Parameters in black are user set in CamExpert or programmable via an imaging application.

Category	Parameter	Value
Camera Information	Sensor ColorType	CFA_RBGG
Camera Control	Internal Line Rate	Not Enabled
I/O Controls	Measured Line Rate	0
Flat Field	Refresh Measured Line Rate	Press...
Image Format	Exposure Time Source	Trigger Width
Transport Layer	Exposure Time	50
Acquisition and Transfer Control	Measured Exposure Time	25.043
Serial Port	Refresh Measured Exposure Time	Press...
File Access Control	Direction Source	Internal
	Internal Direction	Forward
	Offset	0
	Gain Selector	SystemGain
	Gain	3
	Color Transformation Matrix Selector	NoCorrectionFactorySet
	Color Transformation Value Selector	Gain00
	Color Transformation Value	1
	Line Spatial Correction	0
	<< Less	



## Camera Control Feature Descriptions

The following table describes these parameters along with their view attribute and minimum camera firmware version required. Additionally the firmware column will indicate which parameter is a member of the DALSA Features Naming Convention (DFNC), versus the GenICam Standard Features Naming Convention (SFNC not shown).

The Device Version number represents the camera software functional group, not a firmware revision number.

Display Name	Feature	Description	Device Version & View
Sensor Color Type	sensorColorType	Defines the camera sensor color type. (RO)	1.00 DFNC
	CFA_RGB	Sensor color type is RGB	Beginner
	CFA_RGBG		
Internal Line Rate	AcquisitionLineRate	Specifies the camera internal line rate, in Hz when Trigger mode set to internal. Note that any user entered value is automatically adjusted to a valid camera value.	1.00 Beginner
Measured Line Rate	measureLineRate	Specifies the line rate provided to the camera by either internal or external source (RO)	1.00 Beginner
Refresh measured line rate	refreshMeasureLineRate	Press to show the current line rate provided to the camera by either internal or external sources	1.00 Beginner
Exposure Time Source	ExposureMode	Sets the operation mode for the camera's exposure (or shutter). (RO)	1.00 Beginner
Timed	Timed	The exposure duration time is set using the Exposure Time feature and the exposure starts with a LineStart event.	
Trigger Width	TriggerWidth	Uses the width of the trigger signal pulse to control the exposure duration.	
Exposure Time	ExposureTime	Sets the exposure time (in microseconds) when the Exposure Mode feature is set to Timed.	1.00 Beginner
Measured Exposure Time	measureExposureTime	Specifies the exposure time provided to the camera by either internal or external source (RO)	1.00 Beginner
Refreshed measured exposure time	refreshMeasureExposureTime	Press to display the current exposure time provided to the camera.	1.00 Beginner
Direction Source	sensorScanDirectionSource		1.00 Beginner
	Internal	Direction determined by value of SensorScanDirection	
	External	Direction control determined by value on CC3	
Internal Direction	sensorScanDirection	When ScanDirectionSource set to Internal, determines the direction of the scan	1.00 Beginner
	Forward		
	Reverse		
Gain Selector	GainSelector	Selects which gain is controlled when adjusting gain features.	1.00 Beginner

	SystemGain	Apply a digital gain adjustment to the entire image																					
	Red	Apply a digital gain adjustment to the red channel only																					
	Green	Apply a digital gain adjustment to the red channel only																					
	Blue	Apply a digital gain adjustment to the red channel only																					
Gain	Gain	Sets the selected gain as an amplification factor applied to the image.	1.00 Beginner																				
Offset	BlackLevel	Controls the black level as an absolute physical value. This represents a DC offset applied to the video signal, in DN (digital number) units.	1.00 Beginner																				
Color Transformation Selector	colorTransformationSelector	Allows the user to select between two factory programmed matrixes or two user loaded sets	1.00 Beginner																				
	WhiteLEDFactorySet	Color Correction Matrix for a white LED																					
	NoCorrectionFactorySet	No correction																					
	MatrixUserSet1	User programmable/loaded correction matrix																					
	MatrixUserSet2	User programmable/loaded correction matrix																					
Color Transformation Value Selector	ColorTransformationValueSelector	Allows the user to manually adjust correction value in the matrix	1.00 Beginner																				
	Gain00 Gain01 Gain02 Gain10 Gain11 Gain12 Gain20 Gain21 Gain22 Offset1 Offset2 Offset3	<table border="1"> <thead> <tr> <th></th> <th>Red</th> <th>Green</th> <th>Blue</th> <th>Offset</th> </tr> </thead> <tbody> <tr> <th>Red</th> <td>Gain00</td> <td>Gain01</td> <td>Gain02</td> <td>Offset1</td> </tr> <tr> <th>Green</th> <td>Gain10</td> <td>Gain11</td> <td>Gain12</td> <td>Offset2</td> </tr> <tr> <th>Blue</th> <td>Gain30</td> <td>Gain31</td> <td>Gain32</td> <td>Offset3</td> </tr> </tbody> </table>		Red	Green	Blue	Offset	Red	Gain00	Gain01	Gain02	Offset1	Green	Gain10	Gain11	Gain12	Offset2	Blue	Gain30	Gain31	Gain32	Offset3	
	Red	Green	Blue	Offset																			
Red	Gain00	Gain01	Gain02	Offset1																			
Green	Gain10	Gain11	Gain12	Offset2																			
Blue	Gain30	Gain31	Gain32	Offset3																			
Color Transformation Value	ColorTransformationValue	Value entered as pointed to by ColorTransformationValueSelector, $-16 < \text{value} < 16$	1.00 Beginner																				
Line Spatial Correction	sensorLineSpatialCorrection	Set the number of rows between imaging lines	1.00 Beginner																				

## Digital I/O Control Feature Descriptions

The Digital I/O controls, as shown by CamExpert, groups sensor specific parameters. This group includes controls for line rate, exposure time, scan direction, and gain. Parameters in gray are read only, either always or due to another parameter being disabled. Parameters in black are user set in CamExpert or programmable via an imaging application.

Category	Parameter	Value
<a href="#">Camera Information</a>	Trigger Source	CC1
Camera Control	Trigger Selector	LineStart
I/O Controls	Trigger Mode	On
Flat Field	<< Less	
Image Format		
Transport Layer		
Acquisition and Transfer Control		
Serial Port		
File Access Control		

## Digital I/O Control Feature Descriptions

The following table describes these parameters along with their view attribute and minimum camera firmware version required. Additionally the firmware column will indicate which parameter is a member of the DALSA Features Naming Convention (DFNC), versus the GenICam Standard Features Naming Convention (SFNC not shown).

The Device Version number represents the camera software functional group, not a firmware revision number.

Display Name	Feature	Description	Device Version & View
Trigger Source	Trigger Source	Defines the source of external trigger (RO)	1.00 DFNC Beginner
Trigger Selector	Trigger Selector	Defines what the trigger initiates (RO)	1.00 DFNC Beginner
Trigger Mode	Trigger Mode	Determines the source of trigger to the camera, internal or external (CC1)	1.00 DFNC Beginner

# Flat Field Category

The Flat Field controls, as shown by CamExpert, group parameters used to configure camera pixel format, and image cropping. Additionally a feature control to select and output an internal test image simplifies the process of setting up a camera without a lens.

Parameters in gray are read only, either always or due to another parameter being disabled. Parameters in black are user set in CamExpert or programmable via an imaging application. Features listed in the description table but tagged as *Invisible* are usually for Teledyne DALSA or third party software usage—not typically needed by end user applications.

Category	Parameter	Value
Camera Information	Mode	Off
Camera Control	Calibration Algorithm	Basic
I/O Controls	Calibration Target	200
Flat Field	Calibration Sample Size	4096
Image Format	ROI Offset X	1
Transport Layer	ROI Width	8192
Acquisition and Transfer Cont...	Calibrate FPN	Press...
Serial Port	Calibrate PRNU	Press...
File Access Control	Calibrate PRNU Status	Good
	Balance White Auto	Press...
	LUT Mode	Off
	LUT Type	User Defined
	LUT Current Active Set	LUT_Set_1
	LUT Index	0
	LUT Value	0
	Image Filter Mode	Off
	Image Filter Type	Weighted Average
	Image Filter Kernel Size	Kernel 1x3
	Image Filter Contrast Ratio	0.078125

## Flat Field Control Feature Description

The following table describes these parameters along with their view attribute and minimum camera firmware version required. Additionally the firmware column will indicate which parameter is a member of the DALSA Features Naming Convention (DFNC), versus the GenICam Standard Features Naming Convention (SFNC not shown).

The Device Version number represents the camera software functional group, not a firmware revision number.

Display Name	Feature	Description	Device Version & View
Mode	flatfieldCorrectionMode		1.00
Off	Off	FPN and flat field coefficients disabled.	Beginner
On	On	FPN and flat field coefficients enabled.	DFNC
Initialize	Initialize	Reset all FPN to 0 and all flat field coefficients to 1.	

Calibration Algorithm	flatfieldCorrectionAlgorithm	Selection between two different flat field algorithms.	1.00 Beginner DFNC
Basic	Basic	Direct calculation of coefficients based on average line values and target. First each color is flat fielded to its peak value and then the color gains are used to achieve the target.	
LowPass	LowPass	A low pass filter is first applied to the average line values before calculating the coefficients. Use this algorithm if the calibration target is not uniformly white or it is not possible to defocus the image. Because of the low pass filter this algorithm is not able to correct pixel-to-pixel variations and so it is preferable to use the "Basic" algorithm.	
Calibration Target	flatfieldCalibrationTarget	Set a value between 0 and 255 to which the flat field algorithm will target the image to.	1.00 Beginner DFNC
Calibration Sample Size	flatfieldCalibrationSampleSize	Sets the number of lines to be averaged during a flat field calibration	1.00 Beginner DFNC
Lines_2048 Lines_4096	Lines_2048 Lines_4096		
ROI Offset X	flatfieldCalibrationROIOffsetX	Set the starting point of a region of interest where a flat field calibration will be performed	1.00 Beginner DFNC
ROI Width	flatfieldCalibrationROIWidth	Sets the width of the region on interest where a flat field calibration will be performed	1.00 Beginner DFNC
Calibrate FPN	flatfieldCalibrationFPN	Initiates the FPN calibration process	1.00 Beginner DFNC
Calibrate PRNU	flatfieldCalibrationPRNU	Initiates the PRNU or Flatfield process	1.00 Beginner DFNC
Balance White Auto	BalanceWhiteAuto	Initiates the process of balancing the colors to produce a white balance	1.00 Beginner DFNC
LUT Mode	lutModetkkbccf	Sets the enable state of the selected LUT	
	OFF	Disables the LUT	
	Active	Enables the selected LUT	
LUT Type	lutType	Displays the LUT type of the selected LUT	
	User Defined	User defined LUT	
LUT Current Active Set	lutCurrentActiveSet	Specifies the LUT set to use	

	0: LUT_Set_1 1: LUT_Set_2 2: LUT_Set_3 3: LUT_Set_4 4: LUT_Set_5 5: LUT_Set_6 6: LUT_Set_7 7: LUT_Set_8	
LUT Index	LUTIndex	Selects the index (offset) of the coefficient to access in the selected LUT
LUT Value	LUTValue	Returns the value at specified LUT index entry of the LUT selected by the LUT Selector feature
Image Filter Mode	imageFilterMode  Off Active	Sets the enable state of the image filter  Turns off the image filter kernel Enables the selected image filter kernel
Image Filter Type	imageFilterType  Weighted Average Custom	Selects the type of image filter to use  Weighted average algorithm
Image Filter Kernel Size	imageFilterKernelSize Kernel_1x3 Kernel_1x5	Sets the image filter kernel size
Image Filter Contrast Ratio	imageFilterContrastRatio  0 to 256	Set image filter contrast ratio threshold

## Region of Interest (ROI)

The ROI feature is related to flat field calibration. It is important to specify an ROI when the object being imaged has areas that have black, non-illuminated areas such as beyond the edge of a film that is front illuminated, or is saturated, again beyond the edge of a film but in this case bright field back illuminated. The ROI feature allows from one to four specific regions of the pixel line to be specified where flat field calibration will take place. Pixel data outside the ROI will not be used when performing flat field calibration.

## Lookup Table (LUT) Overview

The camera can save up to 8 user-programmable LUT tables as components of its embedded processing features. A LUT is used for operations such as gamma adjustments, invert, and threshold processes. The LUT in the camera is applied to red, green, and blue equally. The LUT size is always 12-bits in and 12-bits out, as this is the size of the processing chain in the camera, regardless of the bit resolution out of the camera.

Pixel data, when read out of the sensor, passes through the LUT memory array, where the newly programmed pixel value then passes to the camera output circuit. The LUT data table is stored along with other parameters using the user configuration function.

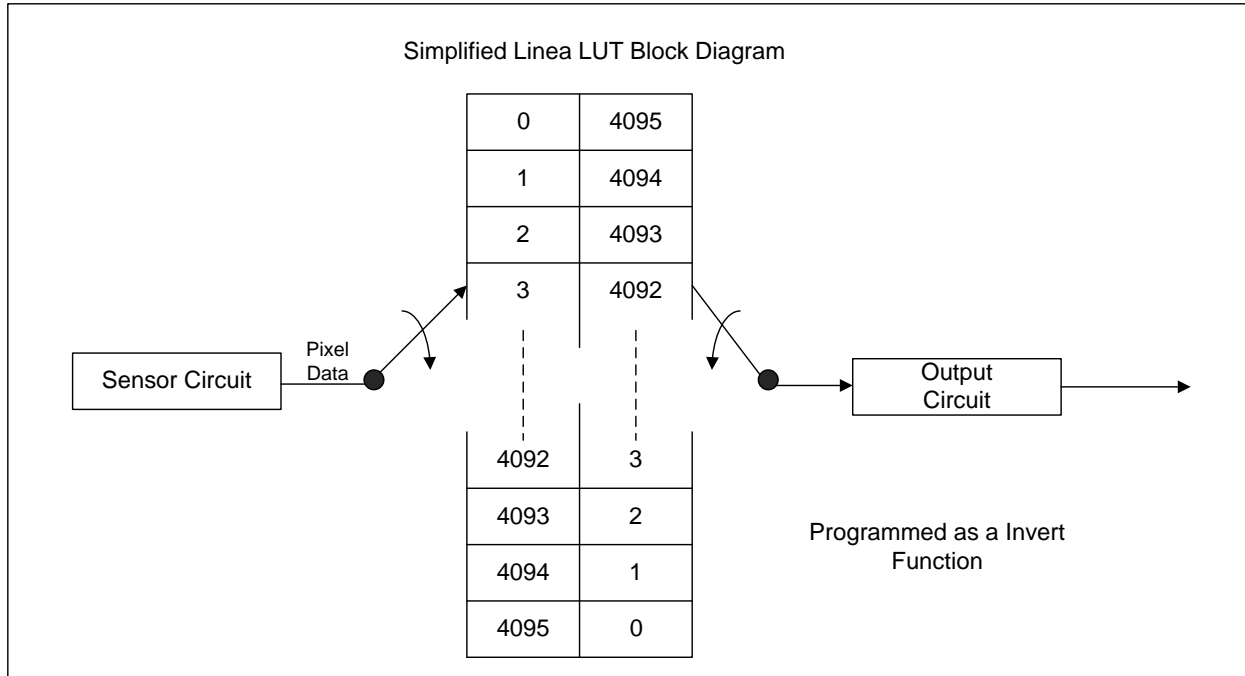

Figure 24: Simplified 12-bit LUT Block Diagram

LUT data can be created using the LUT feature in CamExpert or using an Excel spreadsheet provided by Teledyne Dalsa. To upload a LUT file, use *File Access Control Category > Upload/Download File > Settings* and select Look Up Table.

## Image Format Control Category

The Image Format controls, as shown by CamExpert, group parameters used to configure camera pixel format, image cropping, and the test pattern.

Parameters in gray are read only, either always or due to another parameter being disabled. Parameters in black are user set in CamExpert or programmable via an imaging application.

Features listed in the description table but tagged as *Invisible* are usually for Teledyne DALSA or third party software usage—not typically needed by end user applications.

Parameters <span style="float: right;">×</span>		
Category	Parameter	Value
<b>Board</b>	Test Pattern	Color_Ramp
Basic Timing	Line Mirroring	Off
Advanced Control	Pixel Format	RGB8
External Trigger	Pixel Coding	Color
Image Buffer and ROI	Pixel Color Filter	None
	Width	4096
	WidthMax	4096
<b>Camera - CameraLink_1</b>	Height	1
Camera Information	Multiple AOI Mode	Off
Camera Control	AOI Count	1
Digital IO Control	AOI Selector	1
Flat Field	AOI Offset X	1
<b>Image Format</b>	AOI Width	4096
Transport Layer	<< Less	
Acquisition and Transfer Control		
Serial Port		
File Access Control		



## Image Format Control Feature Description

The following table describes these parameters along with their view attribute and minimum camera firmware version required. Additionally the firmware column will indicate which parameter is a member of the DALSA Features Naming Convention (DFNC), versus the GenICam Standard Features Naming Convention (SFNC not shown).

The Device Version number represents the camera software functional group, not a firmware revision number.

Display Name	Feature	Description	Device Version & View
Test Pattern	TestImageSelector	Selects the type of test image that is sent by the camera. Choices are either as defined by SNFC and/or as provided by the device manufacturer.	1.00 Beginner DFNC
Off	Off	Selects sensor video to be output from sensor	
Ramp	Ramp	Selects a grey scale	
Color_Ramp	Color_Ramp	Selects a color ramp	
Line Mirroring	ReverseX		1.00 Beginner DFNC
Off	Off	Video output in normal order	
On	On	Video output in a reverse order	
Pixel Format	Pixel Format	Output image pixel coding format of the sensor.	1.00 Beginner DFNC
RGB8	RGB8	RGB8	
RGB12	RGB12	RGB12	
RGBG8	RGBG8	RGBG8	
G8	G8	G8	
BGR8	BGR8	BGR8	
BGR12	BGR12	BGR12	
Pixel Color Filter	PixelColorFilter	Indicates the type of color filter applied to the image. (RO)	1.00 Beginner DFNC
Pixel Coding	PixelCoding	(RO)	1.00 Beginner DFNC
Width	Width	Width of the Image provided by the device (in pixels).(RO)	1.00 Beginner
Max Width	WidthMax	The maximum image horizontal dimension of the image. (RO)	1.00 Beginner
Height	Height	Height of the Image provided by the device (in lines). (RO)	1.00 Beginner
Multiple AOI Mode	multipleAOIMode	Turns on an output Area of Interest	1.00 Beginner DFNC
Off	Off	Area of interest is off	
Active	Active	Area of interest is on	
Multiple AOI Count	multipleAOICount	Set the number of output area of interest 1-4	1.00 Beginner DFNC
Multiple AOI Selector	multipleAOISelector	Selects the area of interest to be setup	1.00 Beginner DFNC

AOI Offset X	multipleAOIOffsetX	Set the start of area of interest (pixels)	1.00 Beginner
AOI Width	multipleAOIWidth	Set the width of area of interest (pixels)	1.00 Beginner DFNC
Binning Horizontal	BinningHorizontal	Number of horizontal photo-sensitive cells to combine together. This increases the intensity of the pixels but reduces the horizontal resolution.  Note: horizontal binning cannot be enabled if the GreenOnly mode or RGBG8 mode is selected.	1.00 Beginner
Binning Vertical	BinningVertical	Number of vertical photo-sensitive cells to combine together. This increases the intensity of the pixels but reduces the vertical resolution of the image.	1.00 Beginner

## Image Filters

### Kernels

The camera has a selection of image filters that can be used to reduce the noise in an image.

The options are: no filtering, 1 x 3, and 1 x 5 filter kernels. The 1 x 3 and 1 x 5 filter kernels are “weighted average” filters.

The 1 x 3 filter kernel uses 75% of the original pixel and 12.5% of the adjacent pixels.

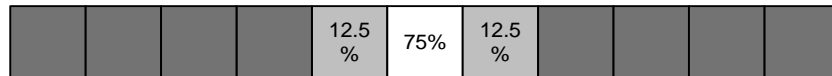

Figure 25: 1 x 3 kernel

The 1 x 5 filter kernel uses 50% of the original pixel and 12.5% of the adjacent two pixels on both sides of the original pixel.

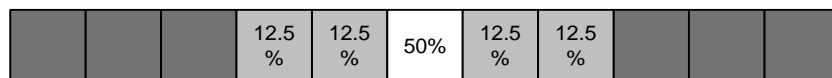

Figure 26: 1 x 5 kernel

### Image Filter Contrast Ratio

The image filter contrast ratio control is used to turn on the filter in an active image. The control looks at the ratio between two adjacent pixels (prior to filter processing) and determines the difference, or contrast, between those pixels. If the contrast ratio is greater than the value set by the user then the filter automatically turns off for those two pixels. If the contrast is below the set value then the pixels are filtered. A value of 0 will turn off the filters for all pixels and a value of 1 will keep the filter on for all pixels.

---

# Binning

Binning is the process where the charge on two (or more) adjacent pixels is combined. This results in increased light sensitivity since there is twice the sensor area to capture photons. The sensor spatial resolution is reduced but the improved low-light sensitivity plus lower signal-noise ratio may solve a difficult imaging situation. The user can evaluate the results of the binning function (factor of 2x) on the camera using CamExpert.

The camera supports horizontal and vertical binning independently. Vertical binning is performed over multiple acquisition lines within the camera and the virtual frame buffer height is automatically reduced when binning is enabled. Also note that binning is performed digitally, therefore there is no increase in acquisition line rate. The following graphic illustrates binning.

Note: horizontal binning cannot be enabled if the GreenOnly camera mode or RGBG8 camera mode is selected.

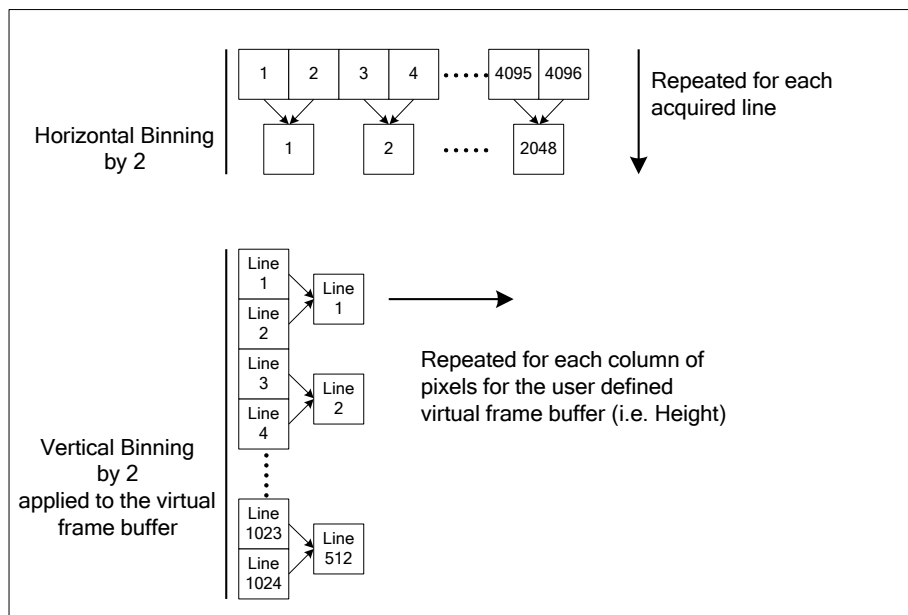

---

# Area of Interest (AOI) Setup

The Area of Interest (AOI) feature can be used to reduce the amount of image-data output from the camera. Use this feature when there are areas in the image that contain unneeded information.

An example where you would use this feature is in an application that is inspecting several separated lanes of objects with one camera and the image between the lanes can be ignored.

The AOI feature allows from one to four specific areas of the pixel line to be specified where image data will be output. Since the AOI feature reduces the amount of data output, this has the additional benefit of allowing the cameras to operate at higher EXSYNC rates when using base, medium, or full camera link modes.

For example, if the total number of pixels for the specified AOI's is less than 1 K when using base Camera Link mode at 85 MHz, the maximum EXSYNC rate can be 48 KHz; versus 10 KHz if all 8k pixels were output.

**Note:** The setup of AOI is always with respect to the sensor. Therefore, if you are using the mirroring mode with AOI, be aware that pixel one will be on the right side of the displayed image.

In order to set up an AOI for the camera:

1. The AOI mode must first be in the off position.
2. Use the AOI Count to select the total number of AOIs desired to a max of 4.
3. To set up each AOI individual use the AOI Selector to point to the AOI to be set up.
4. AOI Offset X is used indicate the starting pixel of the AOI.
5. AOI Width is used to indicate the width of the AOI.

Category	Parameter	Value
Camera Information	Pixel Color Filter	None
Camera Control	Pixel Coding	Color
I/O Controls	Test Pattern	Off
Flat Field	Line	Off
Image Format	Pixel Format	RGB8
Transpo	Width	8192
Acquisition and trans	MaxWidth	8192
Serial Port	Height	1
File Access Control	Multiple AOI Mode	Off
	AOI Count	3
	AOI Selector	1
	AOI Offset X	0
	AOI Width	1000
	<< Less	

The screenshot shows a control panel with a sidebar on the left containing categories like 'Camera Information', 'Camera Control', 'I/O Controls', 'Flat Field', 'Image Format', 'Transpo', 'Acquisition and trans', 'Serial Port', and 'File Access Control'. The main area is a table of parameters and their values. Five callout boxes provide instructions: 1. 'Must be off to set up the AOI.' points to 'Multiple AOI Mode'. 2. 'Set up the number of AOI' points to 'AOI Count'. 3. 'Select area to set up.' points to 'AOI Selector'. 4. 'Select beginning of selected area' points to 'AOI Offset X'. 5. 'Set up width of selected area' points to 'AOI Width'. The 'Multiple AOI Mode' row is highlighted in blue.

In order to initiate operation of the AOI once setup:

1. The AOI mode must be changed to Active.
2. Be sure to set the frame grabber image width to the sum of all AOI widths set up in the camera.

Category	Parameter	Value
<a href="#">Camera Information</a>	Pixel Color Filter	None
Camera Control	Pixel Coding	Color
I/O Controls	Test Pattern	Off
Flat Field	Line Mirroring	Off
Image Format	Pixel Format	RGB8
Transport Layer	Width	8192
Acquisition and Transfer Control	MaxWidth	8192
Serial Port	Height	1
File Access Control	Multiple AOI Mode	Active
	AOI Count	3
	AOI Selector	1
	AOI Offset X	0
	AOI Width	1000

<< Less

Once all AOI are set up change to active.

## Transport Layer Control Category

Parameters in gray are read only, either always or due to another parameter being disabled. Parameters in black are user set in CamExpert or programmable via an imaging application.

Features listed in the description table but tagged as *Invisible* are usually for Teledyne DALSA or third party software usage—not typically needed by end user applications.

Category	Parameter	Value
Camera Information	Camera Link Configuration	Medium
Camera Control	Camera Link Clock Frequency	CL85MHz
I/O Controls	Tap Geometry	Geometry_1X6
Flat Field	Restart Camera	Press...
Image Format	XML Major Version	0
	XML Minor Version	2
Transport Layer	Refresh GenCP Status	Press...
Acquisition and Transfer Control	Last GenCP Status	3
Serial Port	<< Less	
File Access Control		

## Transport Layer Feature Descriptions

The following table describes these parameters along with their view attribute and minimum camera firmware version required. Additionally the firmware column will indicate which parameter is a member of the DALSA Features Naming Convention (DFNC), versus the GenICam Standard Features Naming Convention (SFNC not shown).

Display Name	Feature	Description	Device Version & View
Restart Camera	DeviceReset	Used to restart the camera, warm reset	1.00 Beginner DFNC
XML Major Version	DeviceManifestXMLMajorVersion	Together with DeviceManifestXMLMinorVersion specifies the GenICam™ feature description XML file version (RO)	1.00 Beginner DFNC
XML Minor Version	DeviceManifestXMLMinorVersion	Together with DeviceManifestXMLMajorVersion specifies the GenICam feature description XML file version (RO)	1.00 Beginner DFNC
Last GenCP Status	genCPStatus	If a feature read or write fails then Sopera only returns that it fails – read this feature to get the actual reason for the failure Returns the last error Reading this feature clears it	1.00 Beginner DFNC
Refresh GenCP Status	refreshGenCPStatus	Press to return the current status of the GenCP	1.00 Beginner
Camera Link Configuration	ClConfiguration Base Medium Full Deca	Camera Link Output configuration	1.00 Beginner
Camera Link Configuration	clDeviceClockFrequency CL85MHz CL 62MHz	Set the camera link clock rate	1.00 Beginner
Tap Geometry	DeviceTapGeometry	(RO)	1.00 Beginner

## Acquisition and Transfer Control Category

The Acquisition and Transfer controls, as shown by CamExpert, group parameters used to configure the optional acquisition modes of the device. Parameters in gray are read only, either always or due to another parameter being disabled. Parameters in black are user set in CamExpert or programmable via an imaging application.

Features listed in the description table but tagged as *Invisible* are usually for Teledyne DALSA or third party software usage—not typically needed by end user applications.

Category	Parameter	Value
<a href="#">Camera Information</a>	Device Registers Streaming Start	Press...
Camera Control	Device Registers Streaming End	Press...
I/O Controls	Check Stream Validity	Press...
Flat Field	Registers Valid	Valid
Image Format	<< Less	
Transport Layer		
Acquisition and Transfer Control		
Serial Port		
File Access Control		

## Acquisition and Transfer Control Feature Descriptions

The following table describes these parameters along with their view attribute and minimum camera firmware version required. Additionally the firmware column will indicate which parameter is a member of the DALSA Features Naming Convention (DFNC), versus the GenICam Standard Features Naming Convention (SFNC not shown).

Display Name	Feature	Description	Device Version & View
Device Registers Streaming Start	DeviceRegistersStreamingStart	Announces the start of registers streaming without immediate checking for consistency.	1.00 Beginner DFNC
Device Registers Streaming End	DeviceRegistersStreamingEnd	Announces end of registers streaming and performs validation for registers consistency before activating them.	1.00 Beginner DFNC
Check Stream Validity	DeviceRegistersCheck	Press to check the validity of the current register set.	1.00 Beginner DFNC
Registers Valid	DeviceRegistersValid	States if the current register set is valid and consistent.	1.00 Beginner DFNC



# Serial Port Control Category

The Serial Port control in CamExpert allows the user to select an available camera serial port and review its settings. This section also describes the Genie TS Framework Virtual Serial Port Driver and the use of the Genie TS serial port as an interface from an Ethernet network to a serial port control system for other devices.

Features listed in the description table but tagged as *Invisible* are usually for Teledyne DALSA or third party software usage—not typically needed by end user applications.

Category	Parameter	Value
Camera Information	Baud Rate	Baud_115200
Camera Control	Data Size	Eight_bits
I/O Controls	Parity	None
Flat Field	Stop Bits	One
Image Format	<< Less	
Transport Layer		
Acquisition and Transfer Control		
Serial Port		
File Access Control		

## Serial Port Control Feature Descriptions

The Device Version number represents the camera software functional group, not a firmware revision number.

Display Name	Feature	Description	View
Baud Rate	DeviceSerialPortBaudRate	Sets the baud rate used by the selected device's serial port. Available baud rates are device-specific.	1.00 Beginner DFNC
Baud 9600	Baud 9600	Baud rate is 9600	
Baud 19200	Baud 19200	Baud rate is 19200	
Baud 57600	Baud 57600	Baud rate is 57600	
Baud 115200	Baud 115200	Baud rate is 115200	
Baud 230400	Baud 230400	Baud rate is 230400	
Baud 460800	Baud 460800	Baud rate is 460800	
Serial Port Parity	deviceSerialPortParity	Sets the parity checking type on the selected serial port.(RO)	1.00 Beginner DFNC
None	None	Parity checking is disabled	
Data Size	deviceSerialPortDataSize	Sets the bits per character (bpc) to use (RO).	1.00 Beginner DFNC
Eight Bits	bpc8	Use 8 bits per character	
Stop Bits	deviceSerialPortNumberOfStopBits	Sets the number of stop bits to use.	1.00 Beginner DFNC
Stopbits1	Stopbits1	Use 1 stop bit	

# File Access Control Category

The File Access control in CamExpert allows the user to quickly upload various data files to the connected camera. The supported data files are for camera firmware updates, Flat Field coefficients, LUT data tables, and a custom image for use as an internal test pattern.

Features listed in the description table but tagged as *Invisible* are usually for Teledyne DALSA or third party software usage—not typically needed by end user applications.

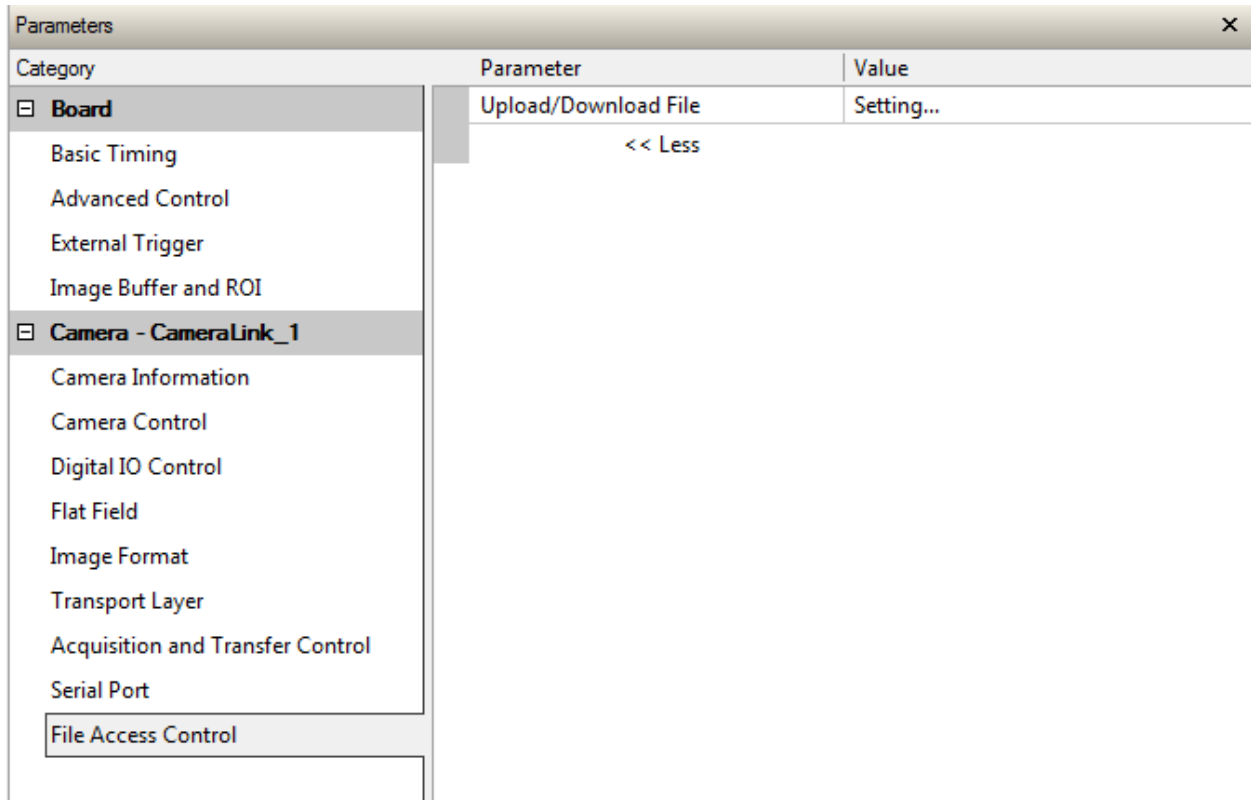

## File Access Control Feature Descriptions

Display Name	Feature	Description	View
File Selector	FileSelector	Selects the file to access. The file types which are accessible are device-dependent.	1.00 Beginner
FPGA Code	Firmware1	Upload new FPGA to the camera which will execute on the next camera reboot cycle.	DFNC
Micro Code		Upload new micro code to the camera which will execute on the next camera reboot cycle.	
CCI		Upload new CCI to the camera which will execute on the next camera reboot cycle.	
XML		Upload new XML to the camera which will execute on the next camera reboot cycle.	
User Set		Use UserSetSelector to specify which user set to access.	
Factory FlatField coefficients		Use UserSetSelector to specify which user flatfield to access.	

User FPN		Use UserSetSelector to specify which user FPN to access.	
ColorCorrectionMatrix		Upload new color correction matrix to the camera.	
CameraData		Download camera information and send for customer support.	
Output LUT		Lookup Table.	
File Operation Selector	FileOperationSelector	Selects the target operation for the selected file in the device. This operation is executed when the File Operation Execute feature is called.	1.00 Guru
Open	Open	Select the Open operation - executed by FileOperationExecute.	
Close	Close	Select the Close operation - executed by FileOperationExecute.	
Read	Read	Select the Read operation - executed by FileOperationExecute.	
Write	Write	Select the Write operation - executed by FileOperationExecute.	
Delete	Delete	Select the Delete operation - executed by FileOperationExecute.	
File Operation Execute	FileOperationExecute	Executes the operation selected by File Operation Selector on the selected file.	1.00 Guru
File Open Mode	FileOpenMode	Selects the access mode used to open a file on the device.	1.00 Guru
Read Write	Read Write	Select READ only open mode Select WRITE only open mode	
File Access Buffer	FileAccessBuffer	Defines the intermediate access buffer that allows the exchange of data between the device file storage and the application.	1.00 Guru
File Access Offset	FileAccessOffset	Controls the mapping offset between the device file storage and the file access buffer.	1.00 Guru
File Access Length	FileAccessLength	Controls the mapping length between the device file storage and the file access buffer.	1.00 Guru
File Operation Status	FileOperationStatus	Displays the file operation execution status. (RO).	1.00 Guru
Success	Success	The last file operation has completed successfully.	
Failure	Failure	The last file operation has completed unsuccessfully for an unknown reason.	
File Unavailable	FileUnavailable	The last file operation has completed unsuccessfully because the file is currently unavailable.	
File Invalid	FileInvalid	The last file operation has completed unsuccessfully because the selected file is not present in this camera model.	
File Operation Result	FileOperationResult	Displays the file operation result. For Read or Write operations, the number of successfully read/written bytes is returned. (RO)	1.00 Guru
File Size	FileSize	Represents the size of the selected file in bytes.	1.00 Guru

## File Access via the CamExpert Tool

1. Click on the "Setting..." button to show the file selection menu.

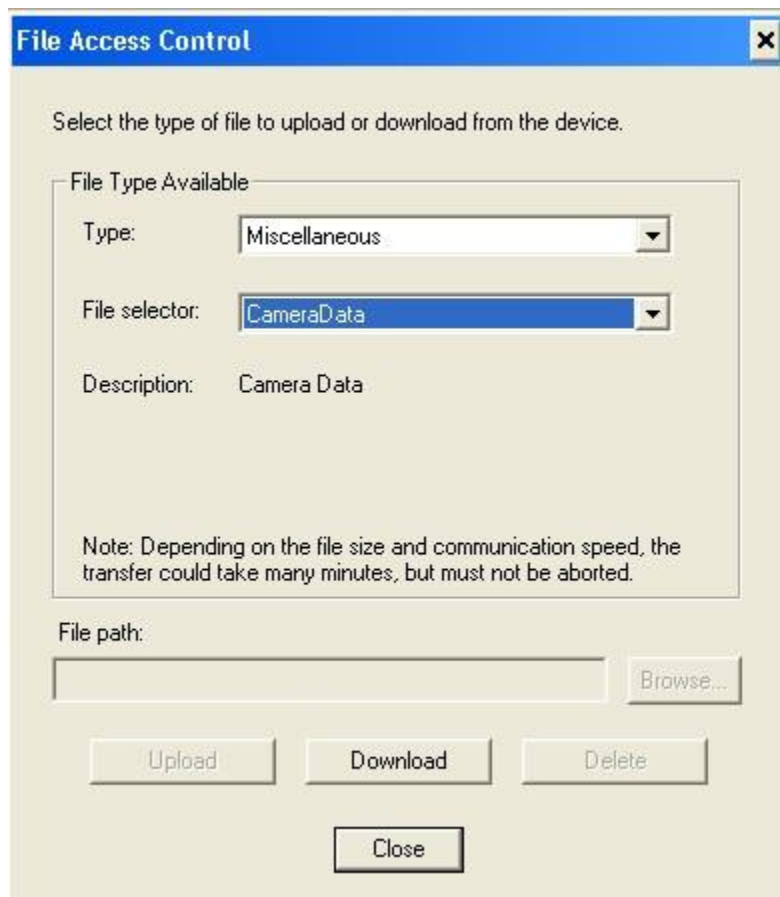

2. From the Type drop menu, select the file type that will be uploaded to the camera.
3. From the File Selector drop menu, select the camera memory location for the uploaded data. This menu presents only the applicable data locations for the selected file type.
4. Click the Browse button to open a typical Windows Explorer window.
5. Select the specific file from the system drive or from a network location.
6. Click the Upload button to execute the file transfer to the camera.
7. Note that firmware changes require a device reset command from the Camera Information Controls and, additionally, CamExpert should be shut down and restarted following a reset.

## Download a List of Camera Parameters

For diagnostic purposes you may want to download a list of all the parameters and values associated with the camera.

1. Go to File Access Control
2. Click on Settings

3. In the "Type" drop down box select "Miscellaneous."
4. In the "File selector" drop down box select "CameraData."

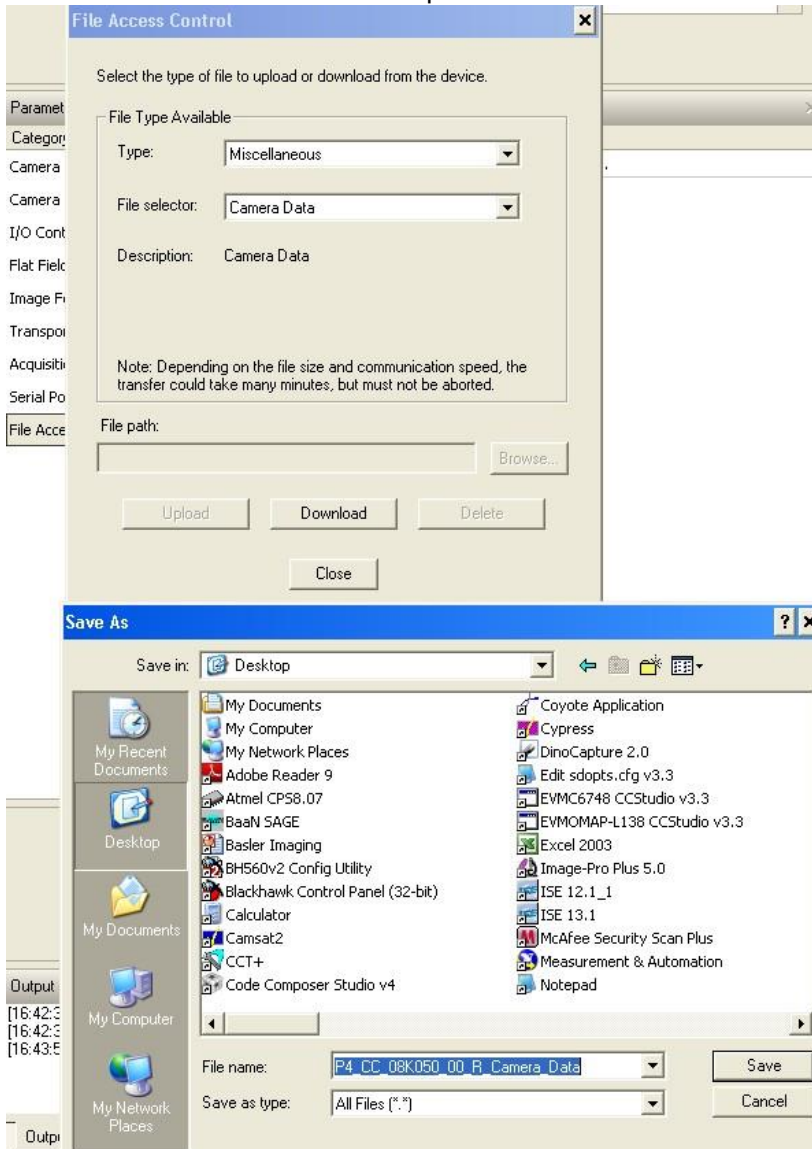

5. Hit "Download"
6. Save the text file and send the file to Teledyne DALSA customer support.

# Appendix B: ASCII Commands

The following commands can be used to control the camera.

## Accessing the Three Letter Commands (TLC)

To access the TLC an ASCII-based communications interface application, such as HyperTerminal.

Additionally it is possible to use the functions of `clserxxx.dll` or `clallserial.dll` as defined in the Camera Link Specification.

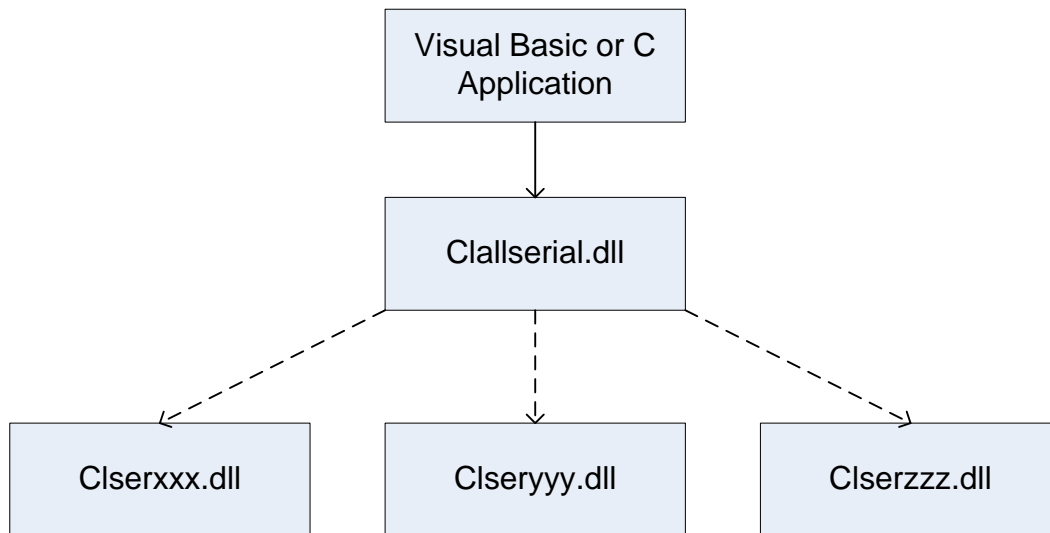

Figure 27: Serial DLL hierarchy as mentioned in the Camera Link Specification

1. Cycle power to the camera: by either a) issuing the reset camera command (rc), or b) powering the camera OFF and then ON.
2. Load the ASCII interface using:
  - 9600 baud
  - 8 data bits
  - no parity
  - 1 stop bit
  - no flow control
  - local echo
  - (carriage return / linefeed)
3. Wait for a stable status LED color (green or red) before proceeding. Note that all entries in HyperTerminal will be ignored until a stable LED color is obtained.

4. In case of HyperTerminal, press the <Esc> key.
5. Once <Esc> has been entered the help screen appears.

## Notes on Using Alternatives to HyperTerminal

- If you are using interfaces other than HyperTerminal, the ASCII character, Esc, is decimal 27 and needs to be issued. From the command line insert Esc by using ALT+2+7 of the activated Num-Pad. In some cases this needs to be followed by a carriage return or a linefeed to send this to the camera.
- In ASCII the Esc character may look like this: “←”.

## ASCII to GenCP

To switch from the ASCII-command interface to the GenCP interface, the camera must be either reset (RC) or the power must be cycled. Note that GenCP and ASCII commands cannot be accessed simultaneously.

Note that the HyperTerminal application is not available on the Windows 7 OS.

### Alternatives to HyperTerminal

The following alternative ASCII-interfaces have been tested and shown to work with this camera: PuTTY and TeraTerm. Note that PuTTY does not have Xmodem capability while TeraTerm does. Xmodem is required to update code in the camera.

TeraTerm <http://logmett.com/index.php?/download/tera-term-473-freeware.html>

PuTTY <http://putty.en.softonic.com/>

The camera responds to a simple ASCII-based protocol. A carriage return <CR> ends each command.

Example: to return the current detector settings  
gcp <CR>

A complete list of the available detector commands, their format and parameters can be displayed by sending the help (h) command.

## Port Configuration

Baud: 9,600  
Bits: 8  
Parity: None  
Stop bits: 1  
Flow Control: None

Echo typed characters locally.

## Rules

- The interface is not case sensitive
- One command and argument(s) per line

- To enter a floating point number prefix it with a "F" – for example "ssg 0 f1.5"
- Error codes returned are the same as the GenICam™ interface – see Diagnostics | Error Codes
- Follow each command with the carriage return character – 0x0D

## Disabling Esc Key for Direct Access to ASCII Commands

By default the Esc key is enabled and an Esc key sequence has to be issued in order to access the ASCII commands. Using the DEK 1 command the need to issue an Esc key is disabled and access to the ASCII commands are available immediately upon camera boot up. Note: access to GENCP is no longer available with the Esc key disabled unless a DEK 0 command is issued and the camera re-booted.

## Commands

Full Name	Balance White Auto	
Mnemonic	BWA	
Argument(s)		
Description	Perform automatic white balance	
Notes	Gain each color such that the average of each is at the same level as the average of the most responsive.	

Full Name	Calibrate User FPN	
Mnemonic	CCF	
Argument(s)	# of lines to average	2048 4096
Description	Calibrate user FPN dark flat field coefficients	

Full Name	Camera Link Speed	
Mnemonic	CLS	
Argument(s)	Frequency	85 MHz 62 MHz
Description	Camera Link clock frequency	

Full Name	Camera Link Mode	
Mnemonic	CLM	
Argument(s)	Mode	Base Medium Full Deca
Description	Camera Link Mode	

Full Name	Color Matrix Selector	
Mnemonic	CMS	
Argument(s)	Device	Factory User
	# of lines to average	0 or 1, when factory selected above then White LED



		No correction (unity matrix)
Description	Color matrix selector	

<b>Full Name</b>	Calibrate Flat Field	
Mnemonic	CPA	
Argument(s)	Algorithm	Basic Low-pass filter
	# of lines to average	2048 4096*
	Target	0 to 255 (8 bit), 0 to 4095 (12 bit)
Description	Calibrate user PRNU flat field coefficients	
Notes	Coefficients are saved and loaded with user set (e.g. USS / USL) Basic algorithm flattens each color and then uses color gains to achieve target Whereas low-pass filter algorithm does not adjust color gains	

<b>Full Name</b>	Color Transformation Value	
Mnemonic	CTV	
Argument(s)	Selector	C <sub>rr</sub> gain C <sub>rg</sub> gain C <sub>rb</sub> gain C <sub>gr</sub> gain C <sub>gg</sub> gain C <sub>gb</sub> gain C <sub>br</sub> gain C <sub>bg</sub> gain C <sub>bb</sub> gain k <sub>r</sub> offset k <sub>g</sub> offset k <sub>b</sub> offset
	Floating Point Value	Gains: -16 to +16 Offsets: 0 to 255
Description	Color Transformation Matrix	
Notes	Value must be immediately preceded with a "F" (e.g. <code>ctv 0 f1.5</code> )	

<b>Full Name</b>	Disable Esc Key	
Mnemonic	DEK	
Argument(s)	Mode	Esc key is enabled Esc key is disabled
	Description	Allow the use of the Esc key to be disabled so that upon boot-up the camera will directly enter the ASCII command mode. With the Esc key disabled the GENCP cannot be accessed.
Notes	To access the GenCP, you have to first issue the DEK 0 command in order to enable the Esc key. Then reboot the camera.	

<b>Full Name</b>		
Mnemonic	FCS	
Argument(s)	File selector	User Set User PRNU FPGA

		Microcode CCI XML User FPN Output LUT Color correction matrix
Description	Upload file to camera using Xmodem protocol (HyperTerminal) User set, PRNU, FPN, and color correction matrix are saved in the currently active set Location to save color correction matrix is specified with CMS command	
Notes	Enter "FCS <#>" command from HyperTerminal Click on "Transfer" Browse and find file Select "Xmodem" protocol Click "Send" When it indicates that it is done click "Close" Upload all files and then reset camera	

Full Name	Flatfield Mode	
Mnemonic	FFM	
Argument(s)	Mode	Disable use of user FPN and PRNU flat field correction coefficients Enable use of user FPN and PRNU flat field correction coefficients Reset user FPN coefficients to zero and user PRNU coefficients to one Scan direction controlled user set loading
Description	Set flat field mode	
Notes		

Full Name	Set Flatfield Scan Direction Reverse Set	
Mnemonic	FRS	
Argument(s)	User Set Number	1 to 8
Description	Set scan direction controlled reverse set	
Notes		

Full Name	Display Camera Configuration	
Mnemonic	GCP	
Argument(s)		
Description	Display current value of camera configuration parameters	
Notes	<pre> USER&gt;gcp Model      LA_CC_08k05B_00_R Microcode  03-081-20382-02 CCI        03-110-20379-02 FPGA       03-056-20562-02 Serial #   19620110 BiST:      Good  DefaultSet 0 Ext Trig   Off Line Rate  6750 [Hz] Meas L.R.  6750 [Hz] Max L.R.   13254 [Hz] Exp. Mode  Timed Exp. Time  74074 [ns] </pre>	

<pre> Meas E.T.    74074 [ns] Max E.T.    146777 [ns]  Test Pat.   0:Off Direction   Internal, Forward Line Delay  1.00 Horiz. Scaling Red/Blue: 0.00 off Vert. Bin   1 Hor. Bin    1 Flat Field  Off Color Plane Selector: All Offset      0 System Gain 1.00 Red Gain    1.00 Green Gain  1.00 Blue Gain   1.00 Color Matrix Selector: Factory 2 Color Correction Matrix: 1.000000, 0.000000, 0.000000, 0                         0.000000, 1.000000, 0.000000, 0                         0.000000, 0.000000, 1.000000, 0  Mirror      Off LUT Set     0 LUT mode    off AOI Mode:   Off CL Speed    85MHz CL Config   Medium Pixel Fmt   RGB8 CPA ROI     1-8192 Image Filter Off Filter Ratio 0.08 </pre>
---

Full Name	Get Value
Mnemonic	GET
Argument(s)	<'parameter>
Description	The "get" command displays the current value(s) of the feature specified in the string parameter. Note that the parameter is preceded by a single quote "'". Using this command will be easier for control software than parsing the output from the "gcp" command.
Notes	<pre> User&gt;get `ssf 10000  Short Full Name          Displayed Value and Description bwa  Balance white auto  No value returned ccf  Calibrate User FPN    No value returned clm  Camera Link Mode     0: Base 1: Med 2: Full 3: Deca cls  Camera Link Speed    0: 85 MHz or 1: 62 MHz cms  Color matrix         0: Factory, 1: User, Selector 1 - 2 cpa  Calibrate Flatfield  No value returned ctv  Color Transformation  Value 12 lines, floating point values                                 Gain 00                                 Gain 01                                 Gain 02                                 Gain 10                                 Gain 11                                 Gain 12                                 Gain 20                                 Gain 21                                 Gain 22                                 Offset 1                                 Offset 2                                 Offset 3 </pre>

ffm	Flat Field Mode	0: Off, 1: On, 2: initialize
gcp	Camera Configuration	No value returned
h	Help	No value returned
lpc	Load Pixel Coefficients	Set 0 - 8
lss	LUT Set Selector	0 to 7
ltm	LUT Mode	0: Off, 1: User defined
rc	Reset Camera	No value returned
roi	Region of Interest	Start pixel and end pixel numbers
rpc	Reset Pixel Coefficients	No value returned
sac	Set AOI Count	Number of AOI's 1-4
sad	Last AOI Set	AOI 1 Offset AOI 1 Width AOI 2 Offset AOI 2 Width
sam	Set AOI Mode	0: Disabled, 1: Enabled
sbh	Set Horizontal Binning	1 or 2
sbr	Set Baud Rate	No value returned
sbv	Set Vertical Binning	1 or 2
scd	Scan Direction	0: Forward, 1: Revers, 2: External
sem	Exposure Mode	0: Internal, 1: External
set	Exposure Time	ns
sgs	Set Gain Selector	
sha	Set Horizontal Alignment	0: Red / Blue, 1: Green, value 0-3
shm	Set Horizontal Alignment Mode	0: Off, 1: Active
sif	Set Image Filter	mode: 0 - 2, contrast: 0 - 256
smm	Mirroring Mode	0: Off, 1: On
spf	Pixel Format	0: RGB8, 2: RGBG8, 3: G8, 4: BGR8, 5: RGB12, 6: BGR12
ssa	Set Spatial Alignment	0 to 3
ssb	Offset	-32 to 31 8-bit DN, -512 to 511 12-bit DN
ssf	Internal Line Rate	Hz
ssg	Gain (four lines)	0: System, 1: Red, 2: Green, 3: Blue, floating point numbers
stm	Trigger Mode	0: Off (Internal), 1: On (External)
sui	set User ID	no value returned
svm	Test Pattern	0: off, 1: mono ramp, 2: color ramp, 9: user defined
usd	Default User Set	Set number 0-8
usl	Load User Set	Last set loaded 0-8
uss	Save User Set	Last set saved 1-8
vt	Temperature	No value returned
vv	Input Voltage	No value returned

Full Name	Help
Mnemonic	H
Argument(s)	
Description	Display list of three letter commands
Notes	<p>USER&gt;h  LA (03-081-20382-02): Command Line Interpreter May 5 2016, 11:51:19</p> <p>bwa - Balance white auto  ccf - Calibrate User FPN &lt;2048 4096&gt;  clm - Camera Link Mode &lt;0:Base 1:Med 2:Full 3:Deca&gt;  cls - Camera Link Speed &lt;0 - 85MHz, 1 - 62MHz&gt;  cms - Color matrix selector &lt;device 0-Factory, 1-User&gt; &lt;Selector 1-2&gt;  cpa - Calibrate Flatfield &lt;0:basic 1:filter&gt;&lt;2048 4096&gt;&lt;DN target&gt;  ctv - Color transformation value &lt;0-Gain00/1-Gain01/2-Gain02/3-Gain10/..../8-Gain22/9-Offset1/10-Offset2/11-Offset3&gt; f&lt;value&gt;</p>

dek	- disable ESC key <0/1>
ffm	- Flat Field Mode <0:Off 1:On 2:Initialiaze>
gcp	- Display Camera Configuration
get	- Get value '<string>
h	- Help
?	- help '<string>
lpc	- Load Pixel Coefficients <set 0-8>
lss	- LUT set selector <0 ~ 7>
ltm	- LUT mode <0-Off, 1-user defined>
rc	- Reset Camera
roi	- Set Flatfield ROI <1st pixel> <last pixel>
rpc	- Reset Flatfield Coefficients
sac	- Set AOI Count <value 1-4>
sad	- Set AOI Selector, Offset and Width <selector 1-AOI Count> <1st pixel> <width >= 40>
sam	- Set AOI Mode <1-enable, 0-disable>
sbh	- Horizontal Binning <1 2>
sbr	- Set Baud Rate <9600 57600 115200 230400 460800 921600>
sbv	- Vertical Binning <1 2>
scd	- Direction <0:Fwd, 1:Rev 2:Ext>
sem	- Exposure Mode <0:Int 1:Ext>
set	- Exposure Time <4000-3330000ns>
sgs	- Set Gain Selector
sha	- Set horizontal alignment <0-Red/blue, 1-Green> f<value 0-3>
shm	- Set horizontal alignment mode < 0-Off, 1-Active>
sif	- Set Image Filter <mode:0~2> <contrast:0~256>
smm	- Mirroring <0:Off 1:On>
spf	- Pixel Format <0:RGB8 2:RGBG8 3:G8 4:BGR8 5:RGB12 6:BGR12>
ssa	- Set Line Delay f<0-3>
ssb	- Offset <8 bit mode: -32~31 or 12 bit mode: -512~511>
ssf	- Internal Line Rate <300-48000>
ssg	- Gain <0:System 1:Red 2:Green 3:Blue> f<gain>
stm	- External Trigger <0:Off 1:On>
sui	- Set User ID
svm	- Test Pattern <0:off 1:Ramp 2:Color Ramp 9: User Defined>
usd	- Default User Set <0-8>
usl	- Load User Set <0-8>
uss	- Save User Set <1-8>
vt	- Temperature
vv	- Input Voltage

Full Name	Load Pixel Coefficients	
Mnemonic	LPC	
Argument(s)	Set selector	0. Factory set 1-8. User sets
Description	Load user set	
Notes	Loads FPN coefficients and PRNU coefficients from a user set ( only coefficeints, no other camera parameters)	

Full Name	Reset Camera	
Mnemonic	RC	
Argument(s)		
Description	Resets the camera to the saved user default settings. These settings are saved using the usd command.	
Notes		

Full Name	Set Flatfield ROI	
Mnemonic	ROI	
Argument(s)	First pixel	1 to 8192*

	Last pixel	1 to 8192*
Description	Flat field region of interest	
Notes	Specifies the pixels that CCF and CPA will calibrate Pixel coefficients outside this region are not changed Last pixel must be greater than or equal to first pixel	

Full Name	Reset Flatfield Coefficients	
Mnemonic	RPC	
Argument(s)		
Description	Reset all user FPN values to zero and all user PRNU coefficients to one	
Notes		

Full Name	Set AOI Count	
Mnemonic	SAC	
Argument(s)	Number of AOI's	1 to 4
Description	Set AOI Counter	
Notes		

Full Name	Set AOI Selector	
Mnemonic	SAD	
Argument(s)	Selector	1 to 4
	Offset	1 to 8192*, multiple of eight
	Width	40 to 8192*
Description	Define an AOI	
Notes	Must not overlap with an already existing AOI	

Full Name	Set AOI Mode	
Mnemonic	SAM	
Argument(s)	Mode	"Off" "Active"
Description	Set AOI mode	
Notes		

Full Name	Set Binning Horizontal	
Mnemonic	SBH	
Argument(s)	Binning	1. Single pixel 2. Binning of 2 pixels
Description	Set horizontal binning	
Notes		

Full Name	Set Binning Vertical	
Mnemonic	SBV	
Argument(s)	Binning	1. Single pixel 2. Binning of 2 pixels
Description	Set vertical binning	
Notes		

Full Name	Set Baud Rate	
Mnemonic	SBR	
Argument(s)	Baud rate	9600 19200 57600 115200 230400 460800
Description	Set baud rate	
Notes	Send command and then change speed of HyperTerminal.	

Full Name	Direction	
Mnemonic	SCD	
Argument(s)	Direction	Forward Reverse External - controlled by CC3 signal
Description	Set sensor scan direction	
Notes		

Full Name	Exposure Mode	
Mnemonic	SEM	
Argument(s)	Mode	Internal External
Description	Set exposure time mode	
Notes	In internal mode the exposure time is controlled by the SET command In external mode the sensor is exposed while CC1 signal is high External mode is only available when the trigger mode is also external (STM 1) SEM 1 overrides internally generated independent exposure times	

Full Name	Exposure Time	
Mnemonic	SET	
Argument(s)	Exposure time	4 000 to 3000000 [ns]
Description	Set internal exposure time	
Notes	Line time > ( Exposure time + 2,000 ns )	

Full Name	Mirroring	
Mnemonic	SMM	
Argument(s)	Mode	Off Image is flipped on the vertical axis
Description	Set mirroring mode	
Notes		

Full Name	Pixel Format	
Mnemonic	SPF	
Argument(s)	Selector	0:RGB8 2:RGB12 3:BGR8

	4:BGR12
Description	Set pixel format
Notes	

<b>Full Name</b>	Set Line Delay	
Mnemonic	SSA	
Argument(s)	# of lines	0 to 3
Description	Sets the number of lines of delay between colors that are read out from the sensor (default 1).	
Notes	If your line rate matches the speed of the object, then the value of the line delay will be 1. Adjust the ssa value until you remove the red and blue halos above and below a black on white horizontal line in order to set the line delay. Values entered must be between 0 and 3. Decimal places are valid for sub-pixel correction.	

<b>Full Name</b>	Offset		
Mnemonic	SSB		
Argument(s)	Offset	8 bit	-32 to 31
Description	Set offset		
Notes	Range changes depending on pixel format (SPF)		

<b>Full Name</b>	Internal Line Rate	
Mnemonic	SSF	
Argument(s)	Line rate	1 to 48,000 [Hz]
Description	Set internal line rate	
Notes	Line time > ( Exposure time + 1,000 ns )	

<b>Full Name</b>	Gain	
Mnemonic	SSG	
Argument(s)	Selector	System Red Green Blue
	Gain	1 to 10
Description	Set gain	
Notes	Multiplier must be immediately preceded with a "F" (e.g. ssg 0 f1.5)	

<b>Full Name</b>	External Trigger	
Mnemonic	STM	
Argument(s)	Mode	Internal External
Description	Set trigger mode	
Notes	In internal mode line rate is controlled by SSF command In external mode readout starts on falling edge of CC1 signal	

<b>Full Name</b>	Test Pattern	
Mnemonic	SVM	
Argument(s)	Mode	Off – sensor video Ramp Color Ramp



Description	Select test pattern
Notes	When a test pattern is selected all digital processing (e.g. flat field, gain) is disabled – it is re-enabled when sensor video is selected

Full Name	Default User Set	
Mnemonic	USD	
Argument(s)	Set selector	0. Factory set 1-8. User sets
Description	Select user set to load when camera is reset	
Notes	The settings include all those listed by the GCP command plus the user FPN coefficients, user PRNU coefficients, and color correction matrix	

Full Name	Load User Set	
Mnemonic	USL	
Argument(s)	Set selector	0. Factory set 1-8. User sets
Description	Load user set	
Notes	Loads and makes current all the settings listed by the GCP command plus the user FPN coefficients, user PRNU coefficients, and color correction matrix	

Full Name	Save User Set	
Mnemonic	USS	
Argument(s)	Set selector	1 to 8
Description	Save user set	
Notes	Saves all the current settings listed by the GCP command plus the user FPN coefficients, user PRNU coefficients, and color correction matrix	

Full Name	Temperature	
Mnemonic	VT	
Argument(s)	0	
Description	Display internal temperature in degrees Celsius	
Notes		

Full Name	Voltage	
Mnemonic	VV	
Argument(s)		
Description	Display supply voltage	
Notes		

# Appendix C: Quick Setup and Image Acquisition

If you are familiar with the operation of Camera Link cameras and have an understanding of imaging fundamentals, the following steps will show you how to quickly set up this camera and begin acquiring images.

## 1. On Power-Up

The Linea-8K color camera has been calibrated and configured at the factory to be ready for your evaluation when first powered up. The default conditions are set as follows:

- System gain is set to the lowest value of one.
- Flat field calibration is *not* active as this feature is dependent on your light source and lens.
- Line rate and exposure time are set to for internal generation by the camera.
- White balance is set for white LEDs.
- Camera Link mode is set to the standard RGB medium mode which allows operation of up to 20 KHz line rate. The camera will run at up to a 34 KHz line rate using Camera Link Deca mode, but it may be easier to start your evaluation using the medium mode. Set your Camera Link frame grabber up to receive the standard RGB medium mode.

## 2. Communicating with the Camera

- The Linea-8K color camera is designed to power up with a GenIcam-compliant interface.
- CamExpert provides an easy-to-use GUI that can be used to set up and evaluate the camera.
- The camera also comes with Teledyne DALSA's three letter command (TLC) interface option, which can be accessed using a suitable terminal program such as HyperTerminal™.
- If you want to use the TLC interface, press the 'Esc' key while using a terminal program and after the LED indicator on the camera turns green. Note that the camera defaults to 9.6 KBaud when first powered up.
- On receiving the 'Esc' character, the camera will output a list of the available TLC commands. You can then proceed to enter TLC commands as required.
- Enter 'h' at any time to get the list of commands from the camera.
- Enter the 'gcp' command at any time to get the current setup conditions of the camera.

## 3. Setting Up Your Optical Configuration

Typically, the first thing you want to do is to evaluate the camera's image quality under operating conditions similar to those that you are likely to use in your application. In order to do this, take the following steps:

- The illumination, lens magnification, and focus should be set up as per your application.
- Getting the magnification right is best accomplished by setting the object-to-sensor distance. Use the formula  $\text{lens focal length} \times (2 + 1/\text{magnification} + \text{magnification})$  to calculate this distance. Magnification equals the sensor pixel size (7.05  $\mu\text{m}$ ) / (your object pixel size in  $\mu\text{m}$ ).
- The approximate location of the sensor position is at the first groove in the side of the case, back from the front face.

#### 4. Camera Timing & Control

It is easiest and quickest to evaluate the camera using the internal timing setups for line rate and exposure time.

- Since we recommend starting with Camera Link medium mode, set a suitable line rate less than 20 KHz, using the 'ssf' command.
- If this line rate is too slow for your application, you will get a compressed image in the scan direction. This should not be a problem for a basic evaluation.
- You can set the exposure time using the 'set' command. Ensure that the exposure time period is not greater than the period of the line rate minus 1.5  $\mu\text{sec}$ .
- The camera will indicate an error if you select an exposure time that is too long. The minimum exposure time is 8  $\mu\text{sec}$ .
- Set your camera direction using the 'scd' command. Refer to the [Camera Direction Control](#) diagram in this manual for a definition of 'forward' and 'reverse'.

#### 5. Acquiring an Image

You can now begin imaging. Unless you have an application employing lots of light, the image is likely to be too dark.

- Use the system gain to adjust the camera output to achieve the desired response. The system gain range is from 1x to 10x.
- Once you have a suitable response, you can now focus the lens.
- If you are using white LEDs, your image will have reasonable color reproduction.
- The image may be darker at the edges due to lens vignetting, but this will be improved once the camera is calibrated.
- Calibration is performed using a white reference where your object is normally located.
  - Use a white material that has no texture, such as a non glossy plastic.
  - If you must use white paper, make sure it is moving during the calibration process. If you do not do this, your image will have vertical stripes.
- Calibration is easily performed using the TLC 'cpa' command.
- The cpa command has two parameters.

- The first is the number of lines you want to average over. Use a value of 8192 to achieve the best average.
- The second is the eight bit target value you want for all three colors after calibration.
- The cpa command takes several seconds to complete. The slower the line rate, the longer it will take.
- On completion of the 'cpa' command, you should see an image from the camera that is white balanced with all three colors at the target level you set.

You are now ready to evaluate the image quality of the camera under your operating conditions.

## 6. Improving Your Color Image

The color response of the camera is quite good even when using white LED's and even without color correction. The camera has a factory set white LED color correction matrix that can be selected to improve color response for those using white LED's. If you are using a different light source, a suitable color correction matrix can be downloaded to the camera. A software tool to generate this is available with the Sapera processing applications, which can be downloaded from the Teledyne DALSA web site (60 day free trial). You will require a MacBeth<sup>®</sup> chart with 4 x 6 color elements that you can scan past the camera to complete the generation of the matrix.

Contact Teledyne DALSA's technical support for further details.

# Appendix D: The Sensor Window Window

## Cleaning and Protecting Against Dust, Oil, and Scratches

The sensor window is part of the optical path and should be handled like other optical components, with extreme care. Dust can obscure pixels, producing dark patches on the sensor response. Dust is most visible when the illumination is collimated. The dark patches shift position as the angle of illumination changes. Dust is normally not visible when the sensor is positioned at the exit port of an integrating sphere, where the illumination is diffuse. Dust can normally be removed by blowing the window surface using an ionized air gun. Oil is usually introduced during handling. Touching the surface of the window barehanded will leave oily residues. Using rubber fingercots and rubber gloves can prevent contamination. However, the friction between rubber and the window may produce electrostatic charge that may damage the sensor. To avoid ESD damage and to avoid introducing oily residues, avoid touching the sensor. Scratches diffract incident illumination. When exposed to uniform illumination, a sensor with a scratched window will normally have brighter pixels adjacent to darker pixels. The location of these pixels will change with the angle of illumination.

An important note on window blemishes:

When flat field correction is performed, window cleanliness is paramount. The figure below shows an example of what can happen if a blemish is present on the sensor window when flat field correction is performed. The blemish will cast a shadow on the wafer. FFC will compensate for this shadow by increasing the gain. Essentially FFC will create a white spot to compensate for the dark spot (shadow). As long as the angle of the incident light remains unchanged then FFC works well. However when the angle of incidence changes significantly (i.e. when a lens is added) then the shadow will shift and FFC will make things worse by not correcting the new shadow (dark spot) and overcorrecting where the shadow used to be (white spot). While the dark spot can be potentially cleaned, the white spot is an FFC artifact that can only be corrected by another FFC calibration.

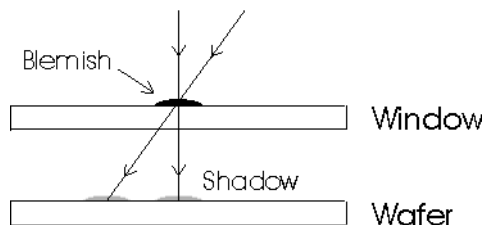

# Cleaning the Sensor Window

## Recommended Equipment

- Glass cleaning station with microscope within clean room.
- Ionized air gun
- Ionized air flood system, foot operated.
- Swabs
- Single drop bottle
- E2 (Eclipse optic cleaning system)

## Procedure

- Use localized ionized air flow on to the glass during sensor cleaning.
- Blow off mobile contamination using an ionized air gun.
- Place the sensor under the microscope at a magnification of 5x to determine the location of any remaining contamination.
- Clean the contamination on the sensor using one drop of E2 on a swab.
- Wipe the swab from left to right (or right to left but only in one direction). Do this in an overlapping pattern, turning the swab after the first wipe and with each subsequent wipe. Avoid swiping back and forth with the same swab in order to ensure that particles are removed and not simply transferred to a new location on the sensor window. This procedure requires you to use multiple swabs.
- Discard the swab after both sides of the swab have been used once.
- Repeat until there is no visible contamination present.

# EMC Declaration of Conformity

We:  
Teledyne DALSA inc.  
605 McMurray Road,  
Waterloo, Ontario, Canada,  
N2V 2E9

Declare under sole legal responsibility that the following products conform to the protection requirements of council directive 2004/108/EC (2014/30/EU after April 2016) on the approximation of the laws of member states relating to electromagnetic compatibility and are CE-marked accordingly:

LA-CC-04K05B-00-R and LA-CC-08K05B-00-R

The products to which this declaration relates are in conformity with the following relevant harmonized standards, the reference numbers of which have been published in the Official Journal of the European Communities:

EN55032 (2012)	Electromagnetic compatibility of multimedia equipment — Emission requirements
EN55011 (2009) with A1(2010)	Industrial, scientific and medical equipment — Radio-frequency disturbance characteristics — Limits and methods of measurement
EN 61326-1 (2013)	Electrical equipment for measurement, control and laboratory use — EMC requirements — Part 1: General requirements
EN 55024 (2010)	Information technology equipment — Immunity characteristics — Limits and methods of measurement

Further declare under our sole legal responsibility that the product listed also conforms to the following international standards:

CFR 47	part 15 (2008), subpart B, for a class A product. Limits for digital devices
ICES-003	Information Technology Equipment (ITE) — Limits and Methods of Measurement
CISPR 11	Industrial, scientific and medical equipment - Radio-frequency disturbance characteristics - Limits and methods of measurement
CISPR 32	Electromagnetic compatibility of multimedia equipment - Emission requirements

Note: this product is intended to be a component of a larger system.

Waterloo, Canada

May 6, 2016



Location

Date

Hank Helmond.  
Director, Quality Assurance

# Revision History

Revision	Change Description	Revision Date
00	Initial release.	May 30, 2016
01	4K model description and specifications added.	November 3, 2016
02	Environmental Specs, page 8 Flash memory size table, page 8 CC1 signal description—notes added: keep signal low when idle, exposure time at or under 3,000 $\mu$ s, page 19. RGB8 CL Full timing added, descriptions + timing diagram, page 21 Hirose power connector diagram revised, page 29.	March 10, 2017



# Index

## B

- baud rate, 45
- Binning, 66
- black level
  - control, 44

## C

- calibration, 47
  - flat field, 49
  - process chain, 47
- camera control signals, 19
- camera information, 36
- camera interfacing tool, 32
- Camera Link
  - cables, 27
  - configurations, 39
  - input signals, 27
  - outputs, 28
- Camera Link connector, 17
- camera state LED, 29
- CamExpert, 33
- cleaning
  - sensor window, 93
- clock signals, 28
- connectors, 17
  - Camera Link, 17
  - power, 28

## D

- data bus, 28
- direction
  - sensor shift, 13
  - web movement, 13
- direction control, 46

## E

- environmental
  - specifications, 8
- exposure
  - control, 39
  - external frame rate,
    - programmable exposure time, 41
  - externally controlled, 41
  - internally controlled, 40
- exposure modes
  - descriptions of, 40
- exposure time
  - set, 44

## F

- EXSYNC, 27

- factory settings, 36

## G

- Gain
  - control, 44
- grounding instructions, 17
- GUI
  - CamExpert, 33
  - overview, 31

## H

- horizontal and vertical
  - binning, 66
- humidity
  - storage and operation, 8

## I

- image acquisition, 40
- input/output, 17
- interface
  - mechanical, 7

## L

- LED
  - definitions, 29
- low-light sensitivity, 66

## M

- mean time between
  - failures (MTBF), 8
- mechanical
  - camera, 14
  - specifications, 7
- MTBF, 8

## P

- performance specifications,
  - 7
- pixel format, 45
- power
  - connector, 28
  - connectors, 28

- guidelines, 28
- pinout, 28
- precautions, 5

## Q

- quantum efficiency
  - graph, 9

## R

- rebooting, 46
- requirements
  - PC, 15
- responsivity
  - graph, 9
- revision history, 95

## S

- safety, 5
- Sapera, 32
- sensor controls, 54, 58, 62, 71
- settings
  - current, 38
  - default, 39

- factory, 36, 39
- loading, 37
- saving, 37
- user, 38

- setup
  - overview, 15
- shift direction, 13
- size
  - image, 44
- spatial resolution, 66
- specifications
  - mechanical, 7
  - performance, 7
- storage temperature, 8

## T

- temperature
  - verify, 37
- test patterns, 35
- trigger modes, 39

## V

- voltage
  - verify, 37